

PCB connector - FKC 2,5/ 2-ST-5,08



1873058

<https://www.phoenixcontact.com/us/products/1873058>

Please be informed that the data shown in this PDF document is generated from our Online Catalog. Please find the complete data in the user documentation. Our General Terms of Use for Downloads are valid.

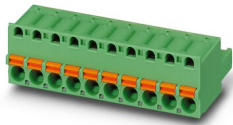

PCB connector, nominal cross section: 2.5 mm², color: green, nominal current: 12 A, rated voltage (III/2): 320 V, contact surface: Tin, type of contact: Female connector, number of potentials: 2, number of rows: 1, number of positions: 2, number of connections: 2, product range: FKC 2,5/...-ST, pitch: 5.08 mm, connection method: Push-in spring connection, conductor/PCB connection direction: 0 °, locking clip: - Locking clip, plug-in system: COMBICON MSTB 2,5, locking: without, mounting: without, type of packaging: packed in cardboard

Your advantages

- Time saving push-in connection, tools not required
- Intuitive use through colour coded actuation lever
- Quick and convenient testing using integrated test option
- Can be combined with the MSTB 2,5 range

Commercial Data

Item number	1873058
Packing unit	1 pc
Minimum order quantity	100 pc
Sales Key	A01
Product Key	AACFBD
Catalog Page	Page 274 (C-1-2013)
GTIN	4017918142445
Weight per Piece (including packing)	3.719 g
Weight per Piece (excluding packing)	3.505 g
Customs tariff number	85366990
Country of origin	DE

PCB connector - FKC 2,5/ 2-ST-5,08



1873058

<https://www.phoenixcontact.com/us/products/1873058>

Technical Data

Product properties

Type	Standard
Product line	COMBICON Connectors M
Product type	PCB plug
Number of positions	2
Pitch	5.08 mm
Number of connections	2
Number of rows	1
Mounting flange	without
Number of potentials	2

Electrical properties

Nominal current I_N	12 A
Nominal voltage U_N	320 V
Pollution degree	3
Contact resistance	1 m Ω
Rated voltage (III/3)	320 V
Rated surge voltage (III/3)	4 kV
Rated voltage (III/2)	320 V
Rated surge voltage (III/2)	4 kV

Connection data

Connection technology

Connector system	COMBICON MSTB 2,5
Nominal cross section	2.5 mm ²
Type of contact	Female connector

Interlock

Locking type	without
Mounting flange	without

Conductor connection

Connection method	Push-in spring connection
Connection direction of the conductor to plug-in direction	0 °
Conductor/PCB connection direction	0 °
Conductor cross section solid	0.2 mm ² ... 2.5 mm ²
Conductor cross section flexible	0.2 mm ² ... 2.5 mm ²
Conductor cross section AWG	24 ... 12
Conductor cross section flexible, with ferrule without plastic sleeve	0.25 mm ² ... 2.5 mm ²
Conductor cross section, flexible, with ferrule, with plastic sleeve	0.25 mm ² ... 2.5 mm ²
2 conductors with the same cross section, flexible, with TWIN	0.5 mm ² ... 1.5 mm ²

PCB connector - FKC 2,5/ 2-ST-5,08



1873058

<https://www.phoenixcontact.com/us/products/1873058>

ferrule with plastic sleeve	
Cylindrical gauge a x b / diameter	2.8 mm x 2.0 mm / 2.4 mm
Stripping length	10 mm

Specifications for ferrules without insulating collar

recommended crimping tool	1212034 CRIMPFOX 6
ferrules without insulating collar, according to DIN 46228-1	Cross section: 0.5 mm ² ; Length: 8 mm ... 10 mm
	Cross section: 0.75 mm ² ; Length: 8 mm ... 10 mm
	Cross section: 1 mm ² ; Length: 8 mm ... 10 mm
	Cross section: 1.5 mm ² ; Length: 8 mm ... 10 mm
	Cross section: 2.5 mm ² ; Length: 10 mm

Specifications for ferrules with insulating collar

recommended crimping tool	1212034 CRIMPFOX 6
ferrules with insulating collar, according to DIN 46228-4	Cross section: 0.5 mm ² ; Length: 8 mm ... 10 mm
	Cross section: 0.75 mm ² ; Length: 8 mm ... 10 mm
	Cross section: 1 mm ² ; Length: 8 mm ... 10 mm
	Cross section: 1.5 mm ² ; Length: 8 mm ... 10 mm
	Cross section: 2.5 mm ² ; Length: 10 mm

Material specifications

Material data - contact

Note	WEEE/RoHS-compliant, free of whiskers according to IEC 60068-2-82/JEDEC JESD 201
Contact material	Cu alloy
Surface characteristics	hot-dip tin-plated
Metal surface terminal point (top layer)	Tin (4 - 8 µm Sn)
Metal surface contact area (top layer)	Tin (4 - 8 µm Sn)

Material data - housing

Housing color	green (6021)
Insulating material	PA
Insulating material group	I
CTI according to IEC 60112	600
Flammability rating according to UL 94	V0
Glow wire flammability index GWFI according to EN 60695-2-12	850
Glow wire ignition temperature GWIT according to EN 60695-2-13	775
Temperature for the ball pressure test according to EN 60695-10-2	125 °C

Material data – actuating element

Color of the actuating lever	orange (2003)
Insulating material	PBT
Insulating material group	I
CTI according to IEC 60112	600

PCB connector - FKC 2,5/ 2-ST-5,08

1873058

<https://www.phoenixcontact.com/us/products/1873058>

Flammability rating according to UL 94	V0
--	----

Dimensions

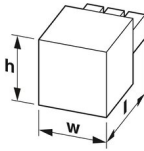
Dimensional drawing	
Pitch	5.08 mm
Width [w]	10.78 mm
Height [h]	15 mm
Length [l]	25.73 mm
Installed height	15 mm

Notes

Notes on operation	In accordance with IEC 61984, COMBICON connectors have no switching power (COC). During designated use, they must not be plugged in or disconnected when carrying voltage or under load.
--------------------	--

Mechanical tests

Test for conductor damage and slackening

Specification	IEC 60999-1:1999-11
Result	Test passed

Repeated connection and disconnection

Specification	IEC 60999-1:1999-11
Result	Test passed

Pull-out test

Specification	IEC 60999-1:1999-11
Conductor cross section/conductor type/tractive force setpoint/actual value	0.2 mm ² / solid / > 10 N
	0.2 mm ² / flexible / > 10 N
	2.5 mm ² / solid / > 50 N
	2.5 mm ² / flexible / > 50 N

Insertion and withdrawal forces

Result	Test passed
No. of cycles	25
Insertion strength per pos. approx.	8 N
Withdraw strength per pos. approx.	6 N

Contact holder in insert

Specification	IEC 60512-15-1:2008-05
Contact holder in insert Requirements >20 N	Test passed

PCB connector - FKC 2,5/ 2-ST-5,08



1873058

<https://www.phoenixcontact.com/us/products/1873058>

Resistance of inscriptions

Specification	IEC 60068-2-70:1995-12
Result	Test passed

Polarization and coding

Specification	IEC 60512-13-5:2006-02
Result	Test passed

Visual inspection

Specification	IEC 60512-1-1:2002-02
Result	Test passed

Dimension check

Specification	IEC 60512-1-2:2002-02
Result	Test passed

Environmental and real-life conditions

Vibration test

Specification	IEC 60068-2-6:2007-12
Frequency	10 - 150 - 10 Hz
Sweep speed	1 octave/min
Amplitude	0.35 mm (10 - 60.1 Hz)
Sweep speed	5g (60.1 - 150 Hz)
Test duration per axis	2.5 h

Durability test

Specification	IEC 60512-9-1:2010-03
Impulse withstand voltage at sea level	4.8 kV
Contact resistance R_1	1 m Ω
Contact resistance R_2	1.1 m Ω
Insertion/withdrawal cycles	25
Insulation resistance, neighboring positions	> 5 M Ω

Climatic test

Specification	ISO 6988:1985-02
Corrosive stress	0.2 dm ³ SO ₂ on 300 dm ³ /40 °C/1 cycle
Thermal stress	100 °C/168 h
Power-frequency withstand voltage	2.21 kV

Ambient conditions

Ambient temperature (operation)	-40 °C ... 100 °C (dependent on the derating curve)
Ambient temperature (storage/transport)	-40 °C ... 70 °C
Relative humidity (storage/transport)	30 % ... 70 %
Ambient temperature (assembly)	-5 °C ... 100 °C

Electrical tests

PCB connector - FKC 2,5/ 2-ST-5,08



1873058

<https://www.phoenixcontact.com/us/products/1873058>

Thermal test | Test group C

Specification	IEC 60512-5-1:2002-02
Tested number of positions	12

Insulation resistance

Specification	IEC 60512-3-1:2002-02
Insulation resistance, neighboring positions	> 5 MΩ

Air clearances and creepage distances |

Specification	IEC 60664-1:2007-04
Insulating material group	I
Comparative tracking index (IEC 60112)	CTI 600
Rated insulation voltage (III/3)	320 V
Rated surge voltage (III/3)	4 kV
minimum clearance value - non-homogenous field (III/3)	3 mm
minimum creepage distance (III/3)	4 mm
Rated insulation voltage (III/2)	320 V
Rated surge voltage (III/2)	4 kV
minimum clearance value - non-homogenous field (III/2)	3 mm
minimum creepage distance (III/2)	3 mm
Rated insulation voltage (II/2)	630 V
Rated surge voltage (II/2)	4 kV
minimum clearance value - non-homogenous field (II/2)	3 mm
minimum creepage distance (II/2)	3.2 mm

Packaging specifications

Type of packaging	packed in cardboard
-------------------	---------------------

Drawings

Diagram

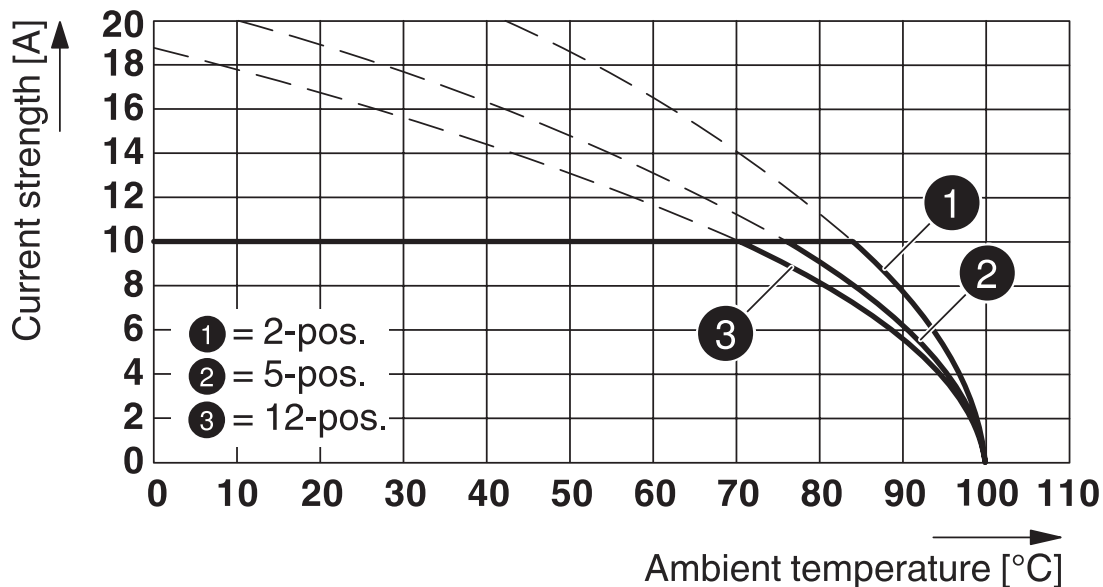

Type: FKC 2,5/...-ST-5,08 with MDSTB 2,5/...-G-5,08

Diagram

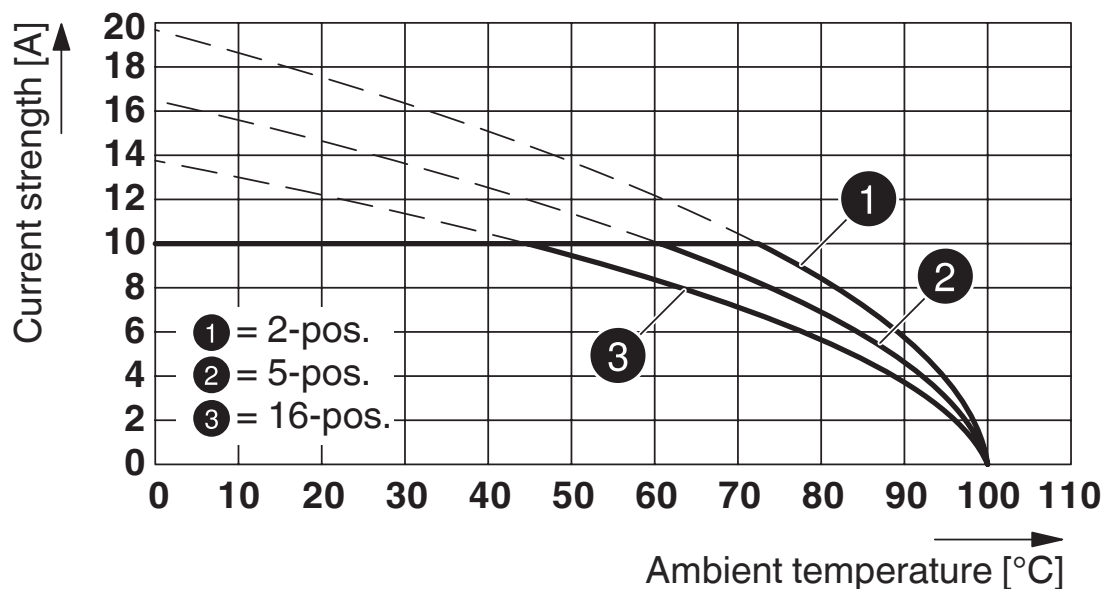

Type: FKC 2,5/...-ST-5,08 with MDSTBVA 2,5/...-G-5,08

1873058

<https://www.phoenixcontact.com/us/products/1873058>

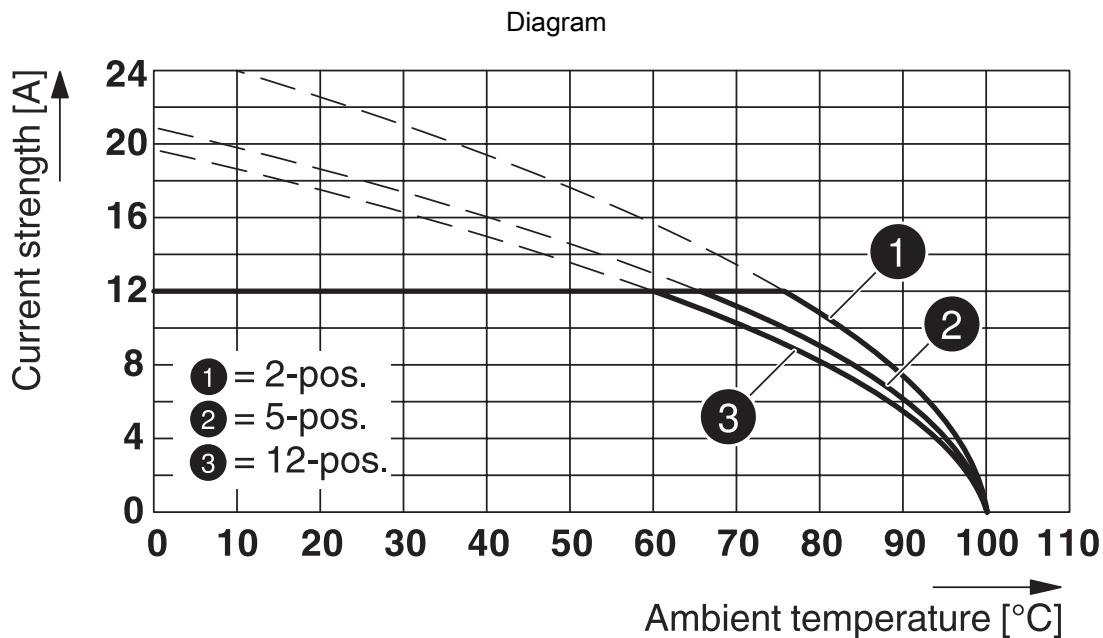

Type: FKC 2,5/...-ST-5,08 with CC 2,5/...-G-5,08 P26THR

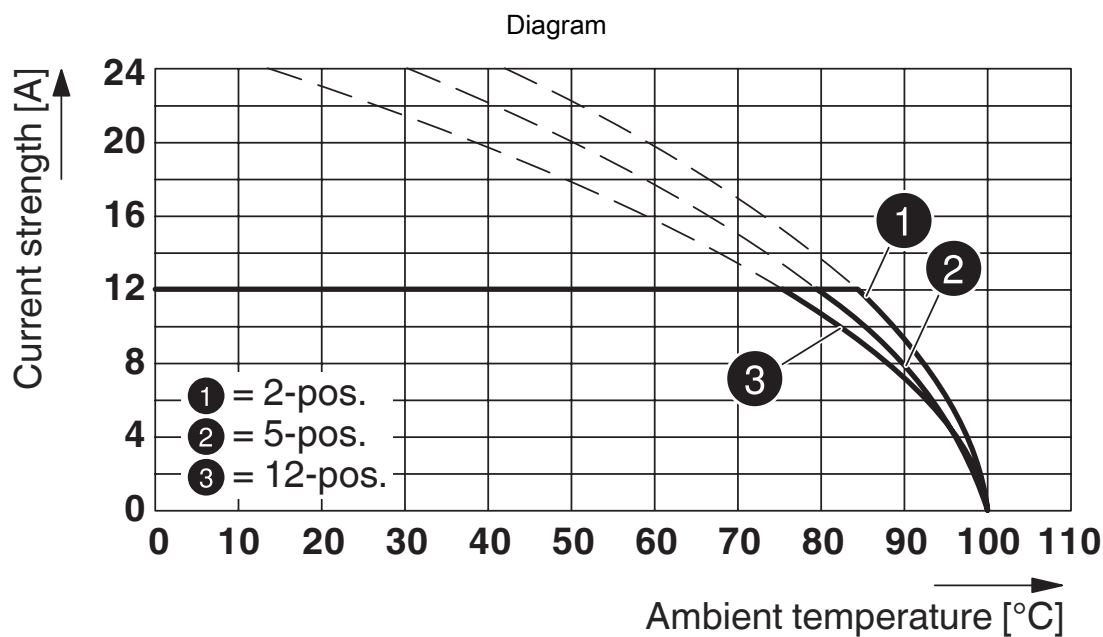

Type: FKC 2,5/...-ST-5,08 with CCV 2,5/...-G-5,08 P26THR

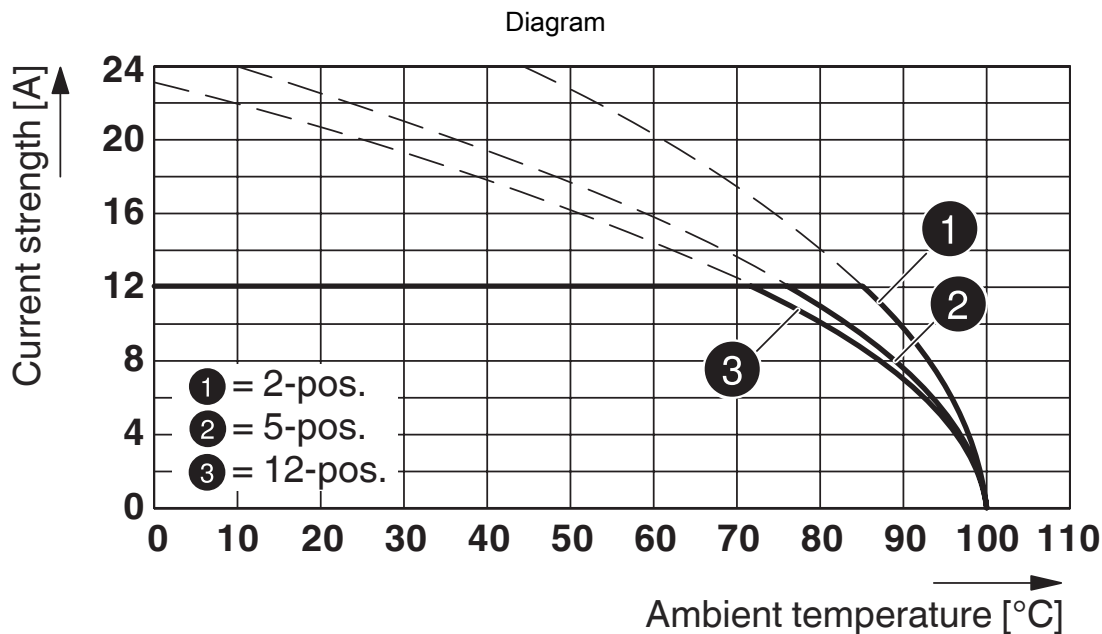

Type: FKC 2,5/...-ST-5,08 with CCVA 2,5/...-G-5,08 P26THR

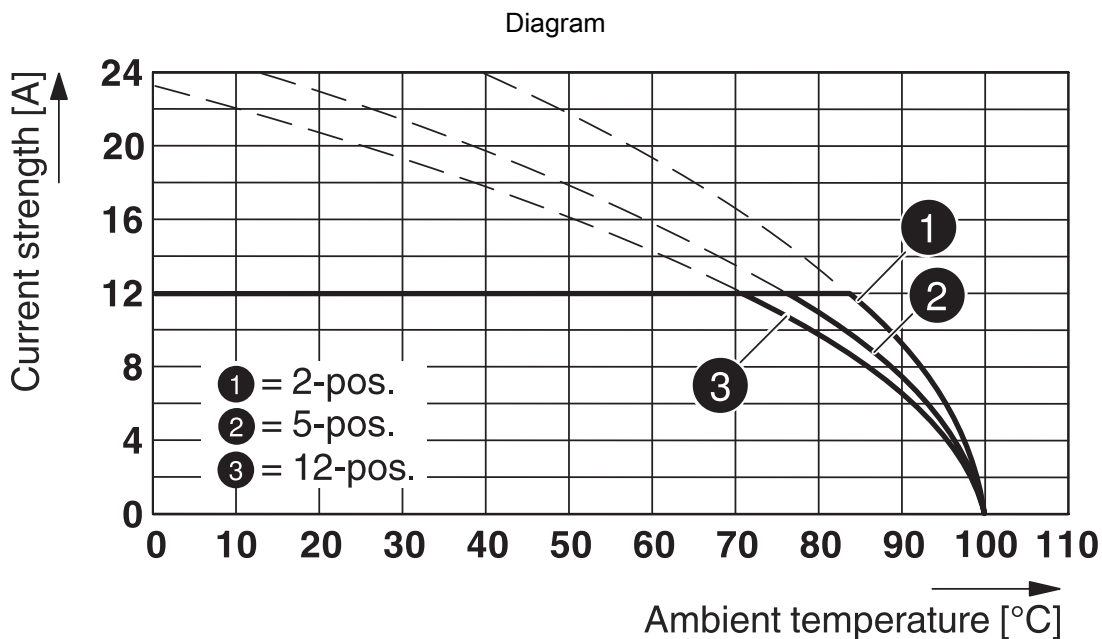

Type: FKC 2,5/...-ST-5,08 with CCA 2,5/...-G-5,08 P26THR

PCB connector - FKC 2,5/ 2-ST-5,08



1873058

<https://www.phoenixcontact.com/us/products/1873058>

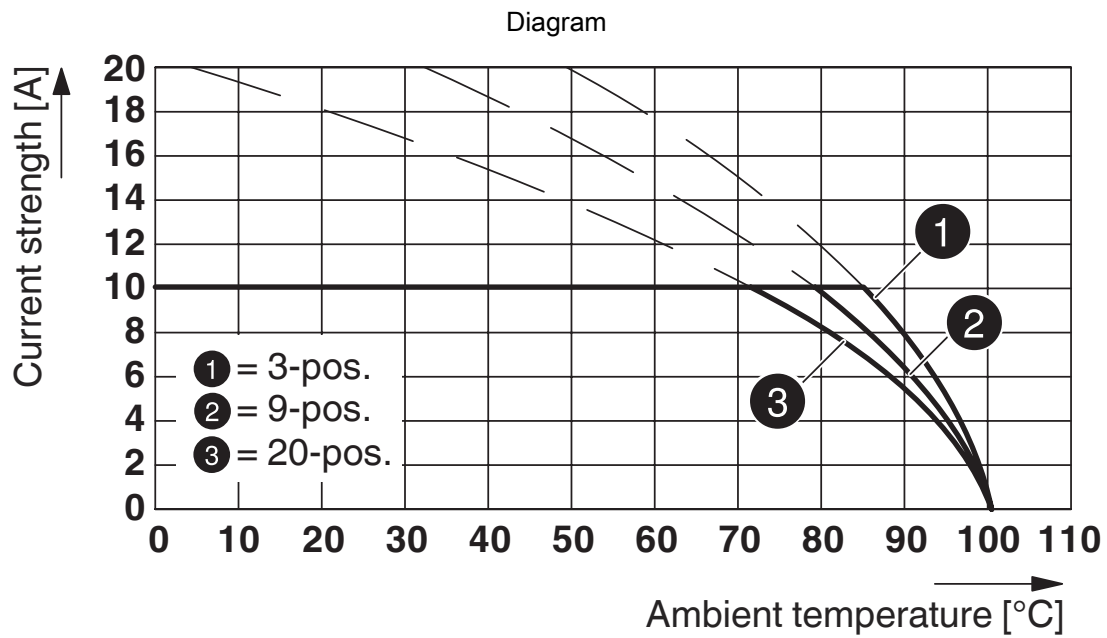

Type: FKC 2,5/...-ST-5,08 with MDSTBV 2,5/...-G1-5,08

PCB connector - FKC 2,5/ 2-ST-5,08





1873058

<https://www.phoenixcontact.com/us/products/1873058>

Approvals

 IECEE CB Scheme Approval ID: DE1-60988-B1B2				
	Nominal Voltage U_N	Nominal Current I_N	Cross Section AWG	Cross Section mm^2
	250 V	12 A	-	0.2 - 2.5

 EAC Approval ID: B.01687				
--	--	--	--	--

 cULus Recognized Approval ID: E60425-19931011				
	Nominal Voltage U_N	Nominal Current I_N	Cross Section AWG	Cross Section mm^2
Use group B	300 V	10 A	26 - 12	-
Use group D	300 V	10 A	26 - 12	-

 VDE Zeichengenehmigung Approval ID: 40050694				
	Nominal Voltage U_N	Nominal Current I_N	Cross Section AWG	Cross Section mm^2
	250 V	12 A	-	0.2 - 2.5

PCB connector - FKC 2,5/ 2-ST-5,08



1873058

<https://www.phoenixcontact.com/us/products/1873058>

Classifications

ECLASS

ECLASS-9.0	27440309
ECLASS-10.0.1	27440309
ECLASS-11.0	27460202

ETIM

ETIM 8.0	EC002638
----------	----------

UNSPSC

UNSPSC 21.0	39121400
-------------	----------

PCB connector - FKC 2,5/ 2-ST-5,08



1873058

<https://www.phoenixcontact.com/us/products/1873058>

Environmental Product Compliance

China RoHS	Environmentally friendly use period: unlimited = EFUP-e
	No hazardous substances above threshold values

PCB connector - FKC 2,5/ 2-ST-5,08

1873058

<https://www.phoenixcontact.com/us/products/1873058>

Accessories

Coding profile

Coding profile - CP-MSTB - 1734634

<https://www.phoenixcontact.com/us/products/1734634>

Coding profile, is inserted into the slot on the plug or inverted header, red insulating material



Strain relief

Strain relief - STZ 4-FKC-5,08 - 1876877

<https://www.phoenixcontact.com/us/products/1876877>

Strain relief for snapping into the latching chambers of the plugs, 4-pos.



PCB connector - FKC 2,5/ 2-ST-5,08

1873058

<https://www.phoenixcontact.com/us/products/1873058>



Strain relief

Strain relief - STZ 8-FKC-5,08 - 1876880

<https://www.phoenixcontact.com/us/products/1876880>



Strain relief for snapping into the latching chambers of the plug components, 8-pos.

Test plugs

Test plugs - MPS-MT - 0201744

<https://www.phoenixcontact.com/us/products/0201744>



Test plugs, with solder connection up to 1 mm² conductor cross section, color: gray

PCB connector - FKC 2,5/ 2-ST-5,08

1873058

<https://www.phoenixcontact.com/us/products/1873058>



Insulating sleeve

Insulating sleeve - MPS-IH WH - 0201663

<https://www.phoenixcontact.com/us/products/0201663>

Insulating sleeve, color: white



Insulating sleeve

Insulating sleeve - MPS-IH RD - 0201676

<https://www.phoenixcontact.com/us/products/0201676>

Insulating sleeve, color: red



PCB connector - FKC 2,5/ 2-ST-5,08

1873058

<https://www.phoenixcontact.com/us/products/1873058>



Insulating sleeve

Insulating sleeve - MPS-IH BU - 0201689

<https://www.phoenixcontact.com/us/products/0201689>

Insulating sleeve, color: blue

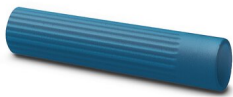

Insulating sleeve

Insulating sleeve - MPS-IH GN - 0201702

<https://www.phoenixcontact.com/us/products/0201702>

Insulating sleeve, color: green



PCB connector - FKC 2,5/ 2-ST-5,08

1873058

<https://www.phoenixcontact.com/us/products/1873058>



Reducing plug

Reducing plug - RPS - 0201647

<https://www.phoenixcontact.com/us/products/0201647>



Reducing plug, color: gray

Screwdriver

Screwdriver - SZS 0,6X3,5 - 1205053

<https://www.phoenixcontact.com/us/products/1205053>



Actuation tool, for ST terminal blocks, insulated, also suitable for use as a bladed screwdriver, size: 0.6 x 3.5 x 100 mm, 2-component grip, with non-slip grip

PCB connector - FKC 2,5/ 2-ST-5,08

1873058

<https://www.phoenixcontact.com/us/products/1873058>

Marker card

Marker card - SK 5,08/3,8:FORTL.ZAHLEN - 0804293

<https://www.phoenixcontact.com/us/products/0804293>



Marker card, white, labeled, horizontal: consecutive numbers 1 ... 10, 11 ... 20, etc. up to 91 ... (99)100, mounting type: adhesive, for terminal block width: 5.08 mm, lettering field size: 5.08 x 3.8 mm

Marker card

Marker card - SK 5,08/3,8:UNBEDRUCKT - 0805412

<https://www.phoenixcontact.com/us/products/0805412>



Marker card, white, unlabeled, can be labeled with: Marker pen, mounting type: adhesive, for terminal block width: 5.08 mm, lettering field size: 5.08 x 3.8 mm

PCB connector - FKC 2,5/ 2-ST-5,08

1873058

<https://www.phoenixcontact.com/us/products/1873058>

PCB header

PCB header - MSTBW 2,5/ 2-G-5,08 - 1735882

<https://www.phoenixcontact.com/us/products/1735882>

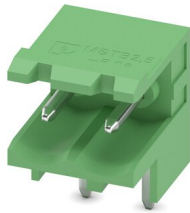

PCB headers, nominal cross section: 2.5 mm², color: green, nominal current: 12 A, rated voltage (III/2): 320 V, contact surface: Tin, type of contact: Male connector, number of potentials: 2, number of rows: 1, number of positions: 2, number of connections: 2, product range: MSTBW 2,5/...-G, pitch: 5.08 mm, mounting: Wave soldering, pin layout: Linear pinning, solder pin [P]: 3.5 mm, number of solder pins per potential: 1, plug-in system: COMBICON MSTB 2,5, Pin connector pattern alignment: Standard, locking: without, mounting: without, type of packaging: packed in cardboard

PCB header

PCB header - MSTBVA 2,5/ 2-G-5,08 - 1755736

<https://www.phoenixcontact.com/us/products/1755736>

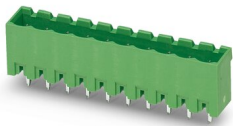

PCB headers, nominal cross section: 2.5 mm², color: green, nominal current: 12 A, rated voltage (III/2): 320 V, contact surface: Tin, type of contact: Male connector, number of potentials: 2, number of rows: 1, number of positions: 2, number of connections: 2, product range: MSTBVA 2,5/...-G, pitch: 5.08 mm, mounting: Wave soldering, pin layout: Linear pinning, solder pin [P]: 3.9 mm, number of solder pins per potential: 1, plug-in system: COMBICON MSTB 2,5, Pin connector pattern alignment: Standard, locking: without, mounting: without, type of packaging: packed in cardboard

PCB connector - FKC 2,5/ 2-ST-5,08

1873058

<https://www.phoenixcontact.com/us/products/1873058>

Feed-through header

Feed-through header - DFK-MSTBVA 2,5/ 2-G-5,08 - 1899139

<https://www.phoenixcontact.com/us/products/1899139>



Feed-through header, nominal cross section: 2.5 mm², color: green, nominal current: 12 A, rated voltage (III/2): 320 V, contact surface: Tin, type of contact: Male connector, number of potentials: 2, number of rows: 1, number of positions: 2, number of connections: 2, product range: DFK-MSTBVA 2,5/..-G, pitch: 5.08 mm, mounting: Wave soldering, pin layout: Linear pinning, solder pin [P]: 3.9 mm, number of solder pins per potential: 1, plug-in system: COMBICON MSTB 2,5, Pin connector pattern alignment: Standard, locking: without, mounting: without, type of packaging: packed in cardboard

PCB header

PCB header - CCV 2,5/ 2-G-5,08 P26THR - 1955387

<https://www.phoenixcontact.com/us/products/1955387>

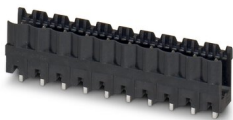

PCB headers, nominal cross section: 2.5 mm², color: black, nominal current: 12 A, rated voltage (III/2): 320 V, contact surface: Tin, type of contact: Male connector, number of potentials: 2, number of rows: 1, number of positions: 2, number of connections: 2, product range: CCV 2,5/..-G, pitch: 5.08 mm, mounting: THR soldering, pin layout: Linear pinning, solder pin [P]: 2.6 mm, number of solder pins per potential: 1, plug-in system: COMBICON MSTB 2,5, Pin connector pattern alignment: Standard, locking: without, mounting: without, type of packaging: packed in cardboard, For user information and design recommendations for through-hole reflow technology, go to: Downloads

PCB connector - FKC 2,5/ 2-ST-5,08



1873058

<https://www.phoenixcontact.com/us/products/1873058>

PCB header

PCB header - CCVA 2,5/ 2-G-5,08 P26THRR32 - 1955963

<https://www.phoenixcontact.com/us/products/1955963>

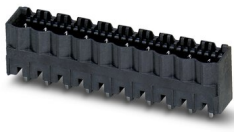

PCB headers, nominal cross section: 2.5 mm², color: black, nominal current: 12 A, rated voltage (III/2): 320 V, contact surface: Tin, type of contact: Male connector, number of potentials: 2, number of rows: 1, number of positions: 2, number of connections: 2, product range: CCVA 2,5/...-G, pitch: 5.08 mm, mounting: THR soldering, pin layout: Linear pinning, solder pin [P]: 2.6 mm, number of solder pins per potential: 1, plug-in system: COMBICON MSTB 2,5, Pin connector pattern alignment: Standard, locking: without, mounting: without, type of packaging: 32 mm wide tape, For user information and design recommendations for through-hole reflow technology, go to: Downloads

Phoenix Contact 2022 © - all rights reserved

<https://www.phoenixcontact.com>

Phoenix Contact USA
586 Fulling Mill Road
Middletown, PA 17057, United States
(+717) 944-1300
info@phoenixcon.com