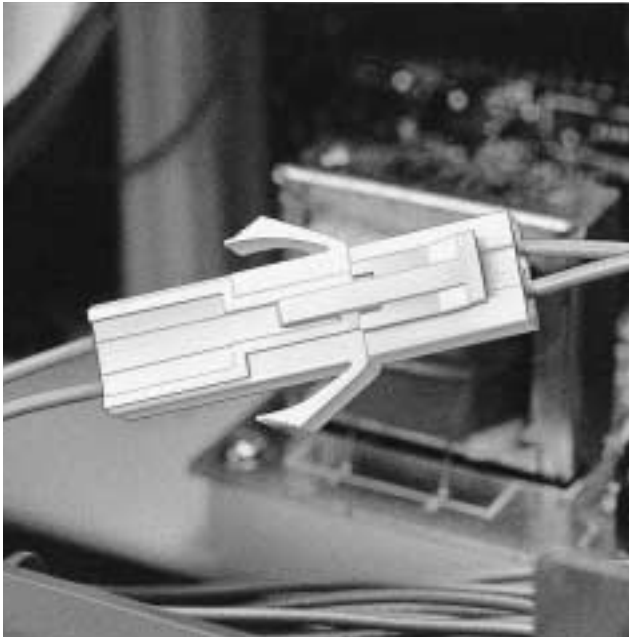

JST

Crimp

4.5mm
(.177") pitch

EL CONNECTOR

Disconnectable Crimp style Wire-to-wire connectors

The contacts for the compact EL connector can be easily inserted into the connector housings. The plug housing and the receptacle housing can be smoothly mated even if they are mechanically distorted.

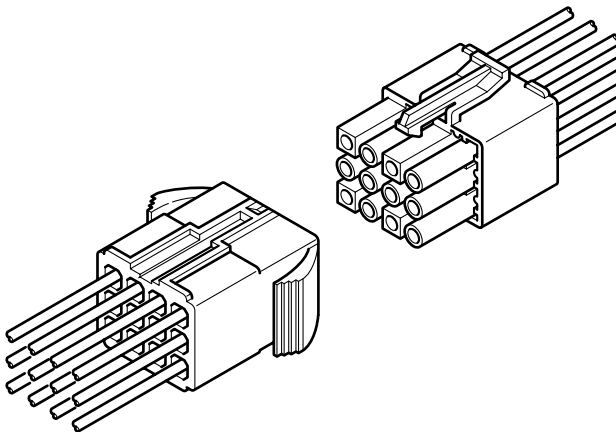

Features

• **Easy insertion and secure installation of contacts**

Each contact has a pair of locking lances so that the contact can be installed and symmetrically locked in the housing.

A lance retraction prevention mechanism is also provided so that the contact will be securely held in the housing. The lances have sufficient clearance to allow the contacts to be easily inserted into the housing.

• **A smooth connection even when pried during mating**

The contact is held by the housing along a wide surface area.

This reduces the deflection of the contact and ensures a smooth, safe connection even when pried during mating.

• **Durable arm lock mechanism**

The arm lock mechanism of the housing is slit to prevent stress concentration during connection. Thus, it is highly durable and will survive repeated matings.

• **Two contact styles**

Two different kinds of crimp contacts are available for convenient branching or internal jumpering.

Specifications

- Current rating: 10A AC, DC max.
- Voltage rating: 300V AC, DC max.
- Temperature range: -25°C to +90°C
(including temperature rise in applying electrical current)
- Contact resistance: Initial value/7m Ω max.
After environmental testing/10m Ω max.
- Insulation resistance: 1,000M Ω min.
- Withstanding voltage: 1,500V AC/minute
- Applicable wire: AWG #26 to #16
0.13 to 1.25mm²
- Applicable panel thickness: 0.8 to 2.0mm (.031" to .079")

* Contact JST for details.

Note: The current rating varies depending on the number of circuits and the wire size used in each connector. The table below lists the current rating as a function of the number of circuits and the wire size.

Current unit: A

Circuits	Wire size (AWG)					
	#16	#18	#20	#22	#24	#26
2	10	6	5	4	4	3
3	10	6	5	4	4	3
4	10	6	5	4	4	3
6	8	5	4	3	3	3
9	6	4	3	3	2	2
12	6	4	3	3	2	2
15	6	4	3	3	2	2

Standards

Recognized E60389

Certified LR20812

R75052

Approved according to DIN/VDE 0627<Reg. No. 3516>

Current rating: AC 250V, DC 300V

Voltage rating: 6A, 5A, 4A, 3A

Insulation group: B

Kind of protection: IP 00

Applicable wires: AWG 18-26

Creepage current stability: KB 380

Contact

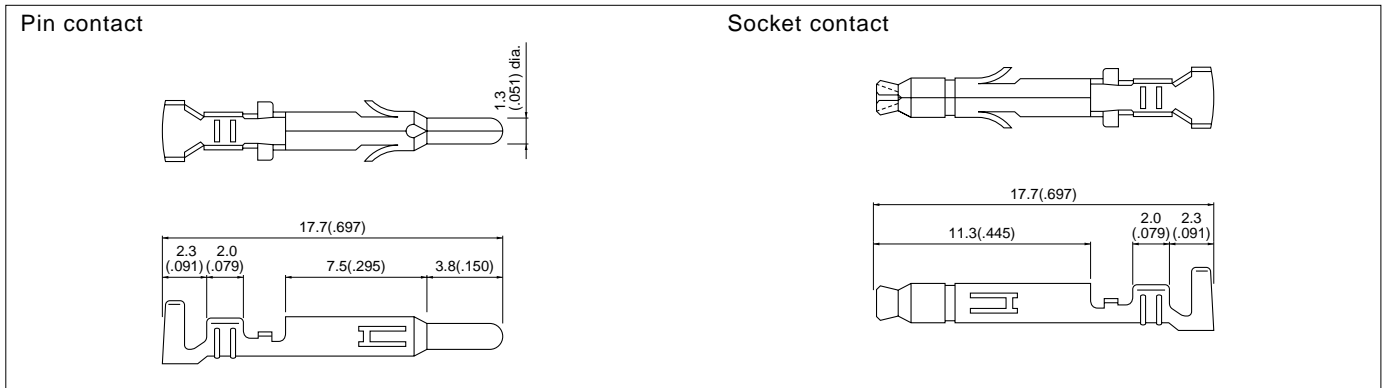

Model No.		Applicable wire			Q'ty / reel
Pin contact	Socket contact	mm ²	AWG #	Insulation O.D. mm(in.)	
SLM-01T-P1.3E	SLF-01T-P1.3E	0.13 to 0.5	26 to 20	1.3 to 2.7 (.051 to .106)	6,000
SLM-41T-P1.3E	SLF-41T-P1.3E	0.5 to 1.25	20 to 16	1.9 to 3.4 (.075 to .134)	4,000
*SLM-42T-P1.3E	*SLF-42T-P1.3E	0.3+0.3 to 0.5+0.5	22+22 to 20+20	1.7+1.7 to 2.0+2.0 (.067+.067 to .079 +.079)	

Material and Finish

Phosphor bronze, tin-plated

Note: 1. Contact denoted by * is used for two wires.
2. Contact JST for special products.

Housing

Material: Nylon 6, UL94V-0, white

Circuits	Voltage rating	Current rating	Receptacle housing(for pin contact)		Q'ty / bag	Plug housing(for socket contact)		Q'ty / bag
			Model No.	Dimensions		Model No.	Dimensions	
2	300V	10.0A	ELR-02V		500	ELP-02V		500
			ELR-02VF			ELP-02V		
3	300V	10.0A	ELR-03V		500	ELP-03V		500

EL CONNECTOR

Housing

Material: Nylon 6, UL94V-0, white

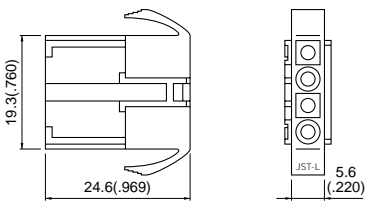
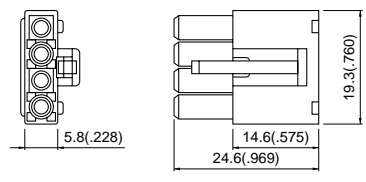
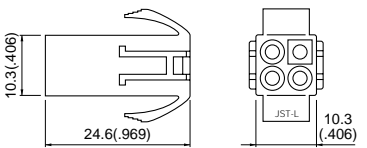
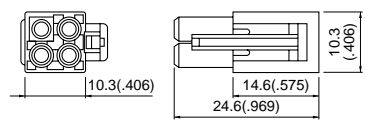
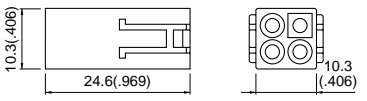
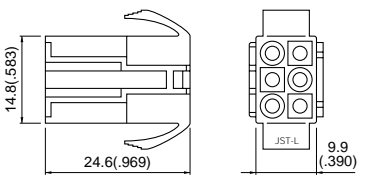
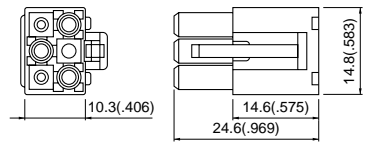
Circuits	Voltage rating	Current rating	Receptacle housing(for pin contact)		Plug housing(for socket contact)	
4	300V	10.0A	ELR-04V 	Q'ty / bag	ELP-04V 	Q'ty / bag
			ELR-04NV 	Q'ty / bag	ELP-04NV 	Q'ty / bag
			ELR-04NVF 	500	500	
6	300V	8.0A	ELR-06V 	Q'ty / bag	ELP-06V 	Q'ty / bag
			500	500		

Housing

Material: Nylon 6, UL94V-0, white

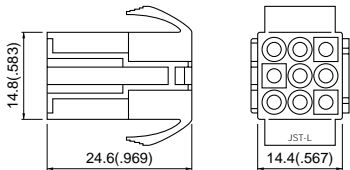
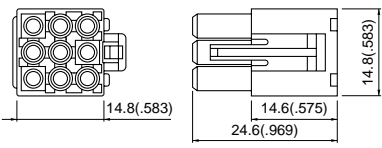
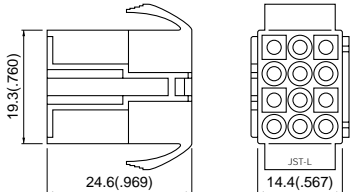
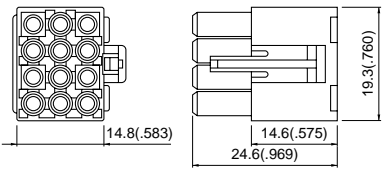
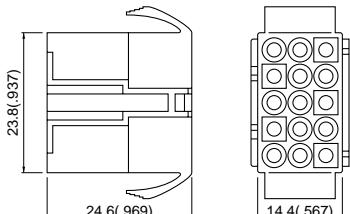
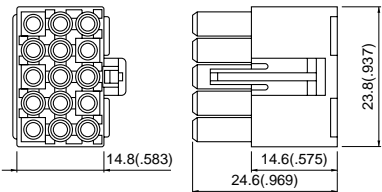
Circuits	Voltage rating	Current rating	Receptacle housing(for pin contact)		Q'ty / bag	Plug housing(for socket contact)		Q'ty / bag
9	300V	6.0A	ELR-09V 		500	ELP-09V 		500
12	300V	6.0A	ELR-12V 		500	ELP-12V 		500
15	300V	6.0A	ELR-15V 		500	ELP-15V 		500

Note:

1. ELR-02VF and ELR-04NVF are exclusively for free hanging. The other circuits can be used either for panel mounted or free hanging. The panel hole dimensions are given on the next page.
2. Contact JST for special products.

EL CONNECTOR

Contact position location numbers

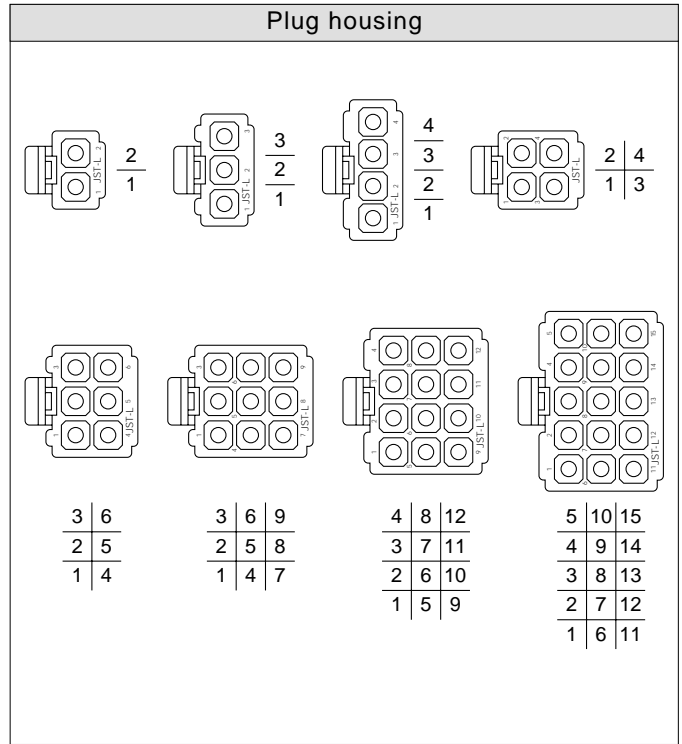
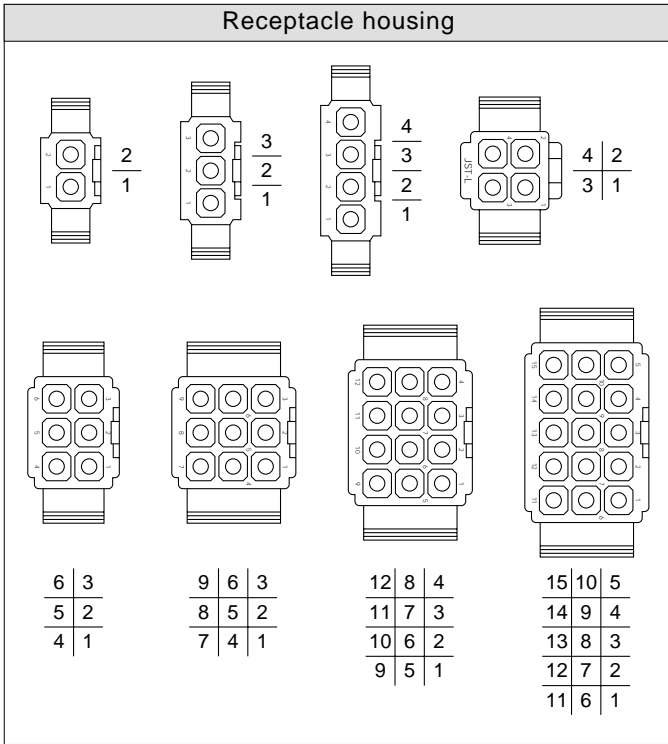
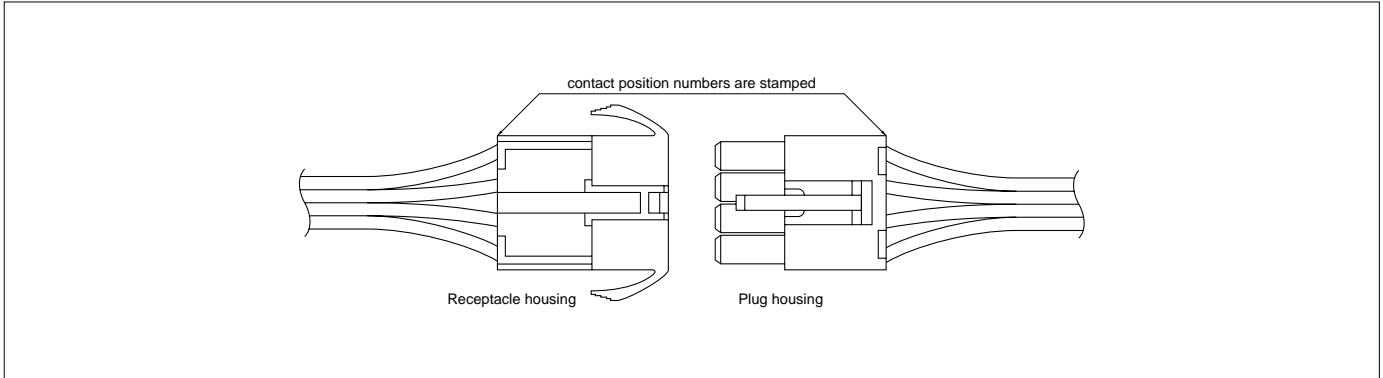

Panel layout

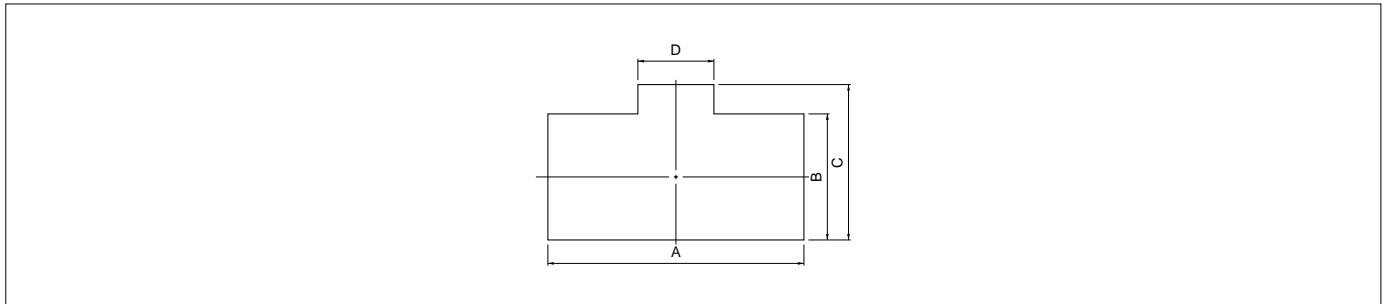

Circuits	Receptacle housing Model No.	Panel hole dimensions mm(in.)				Applicable panel thickness mm(in.)
		A	B	C	D	
2	ELR-02V	15.0(.591)	6.0(.236)	6.85(.270)	5.2(.205)	0.8 to 2.0 (.031 to .079)
3	ELR-03V	19.7(.776)	6.0(.236)	6.85(.270)	5.2(.205)	
4	ELR-04V	24.2(.953)	6.0(.236)	6.85(.270)	5.2(.205)	
	ELR-04NV	15.6(.614)	10.6(.417)	11.6(.457)	5.2(.205)	
6	ELR-06V	19.7(.776)	10.2(.402)	11.1(.437)	5.2(.205)	
9	ELR-09V	19.7(.776)	14.8(.583)	15.7(.618)	5.2(.205)	
12	ELR-12V	24.2(.953)	14.8(.583)	15.7(.618)	5.2(.205)	
15	ELR-15V	28.7(1.130)	14.8(.583)	15.7(.618)	5.2(.205)	

Note:

1. Punch holes in the panel according to the sketch and table shown above. Burrs must be removed.
2. The strength of the panel must be considered when punching two or more holes.
3. The connector must be inserted from the same side as the hole is punched.

Assembly layout

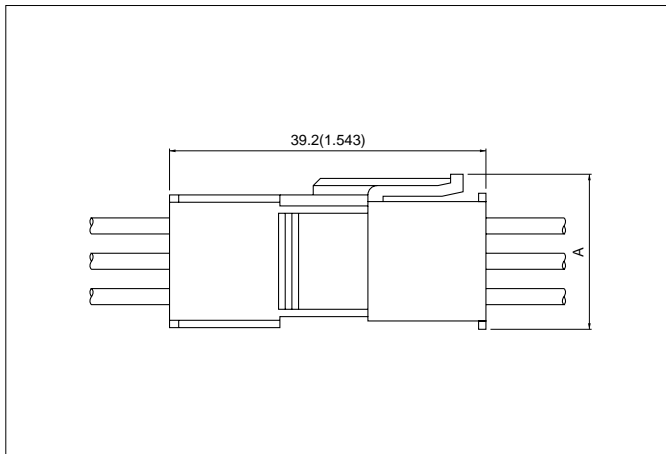

Circuits	Dimensions A mm(in.)
2 to 4 (Single-line arrangement)	10.4(.409)
4 (Double-line arrangement)	15.2(.598)
6	14.9(.587)
9 to 15	19.4(.764)

Applicator for the semi-automatic press AP-K2N

Contact	Crimp applicator MKS-L		Compact Crimp applicator MKS-LS		Strip-crimp applicator MKS-SC
	with safety cover	without safety cover	with safety cover	without safety cover	with safety cover
SLF-01T-P1.3E	APLMK SLF/M01-13E	APLNC SLF/M01-13E	-	-	APLSC SLF/M01-13E
SLM-01T-P1.3E	APLMK SLF/M01-13E	APLNC SLF/M01-13E	-	-	APLSC SLF/M01-13E
SLF-41T-P1.3E	APLMK SLF/M41-13E	APLNC SLF/M41-13E	-	-	APLSC SLF/M41-13E
SLM-41T-P1.3E	APLMK SLF/M41-13E	APLNC SLF/M41-13E	-	-	APLSC SLF/M41-13E
SLF-42T-P1.3E	APLMK SLF/M42-13E	APLNC SLF/M42-13E	-	-	-
SLM-42T-P1.3E	APLMK SLF/M42-13E	APLNC SLF/M42-13E	-	-	-