

D SUBMINIATURE CONNECTOR J SERIES

Solder pot plug and receptacle

SOLDER POT PLUG AND RECEPTACLE



Solder pot plug



Solder pot Receptacle

Features

- The receptacle contacts are formed by high-speed stamping presses to obtain the advantages of cold working. They are therefore highly elastic, which in turn ensures reliable connection even after many mating cycles.
- The dimples in the plug shell ensure continuity between it and the receptacle shell, thus providing complete shielding.
- Costs are kept low by selective gold plating the contacts.
- The solder cup portions of the contacts are tin-plated for easy soldering.
- Insulator housings are made of a heat-resistant glass-filled PBT resin.

Standards

Recognized E60389 Certified LR20812

Specifications

Materials

Connector	Part name	Material and Finish
Plug	Contact	Brass, nickel-undercoated, selective gold-plated or copper-undercoated, tin-plated
	Insulator	Glass-filled PBT, UL94V-0, black
	Shell	Mild steel, copper-undercoated, tin/lead-plated
Receptacle	Contact	Phosphor bronze, nickel-undercoated, selective gold-plated or copper-undercoated, tin-plated
	Insulator	Glass-filled PBT, UL94V-0, black
	Shell	Mild steel, copper-undercoated, tin/lead-plated

Characteristics

Current rating	3A, AC, DC (2A for 37-circuits)
Voltage rating	250V AC, DC
Temperature range	-40°C to +85°C (including temperature rise in applying electrical current)
Contact resistance	Initial value/15mΩ max. After environmental testing/30mΩ max.
Insulation resistance	5,000MΩ min.
Withstanding voltage	1,000V AC/minute

Note: Contact JST for details.

Model number identification

J	E	Z	—	9	P	—	12
• Series name							
• Shell size: E, A, B, C							
• Wire connection style: Z ... Solder pot type							
• Number of circuits: 9, 15, 25, 37							
• Connector style: P ... Plug, S ... Receptacle							
• Finish							
Blank ... Gold-plated (flash)				12 ... 0.2micron(8micro-inch) gold-plated			
13 ... 0.4micron(16micro-inch) gold-plated				14 ... 0.76micron(30micro-inch) gold-plated			
90 ... Tin-plated							

Note: 1. The relationship between number of circuits and shell size is shown below.

9: E, 15: A, 25: B, 37: C

2. Contact JST for special plating requirements.

D SUBMINIATURE CONNECTOR J SERIES

Plug

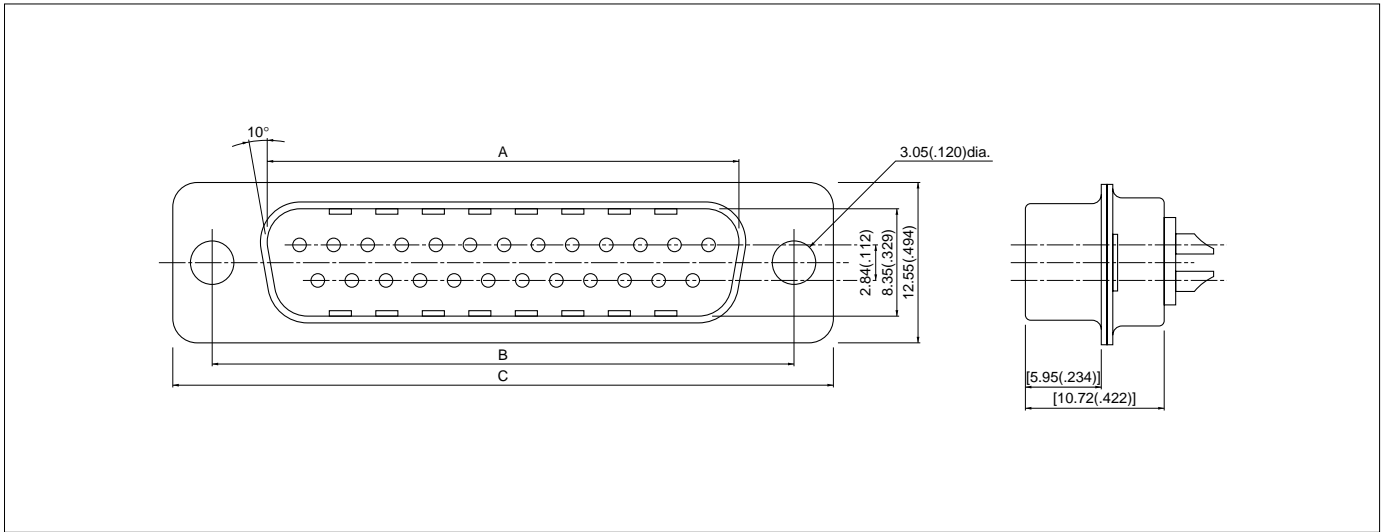

Circuits	Model No.		Dimensions mm(in.)			Q'ty / box
	Gold-plated	Tin-plated	A	B	C	
9	JEZ- 9P	JEZ- 9P-90	16.92(.666)	24.99(.984)	30.80(1.213)	100
15	JAZ-15P	JAZ-15P-90	25.25(.994)	33.32(1.321)	39.14(1.541)	100
25	JBZ-25P	JBZ-25P-90	38.97(1.534)	47.04(1.852)	53.04(2.088)	50
37	JCZ-37P	JCZ-37P-90	55.43(2.182)	63.50(2.500)	69.32(2.729)	50

Receptacle

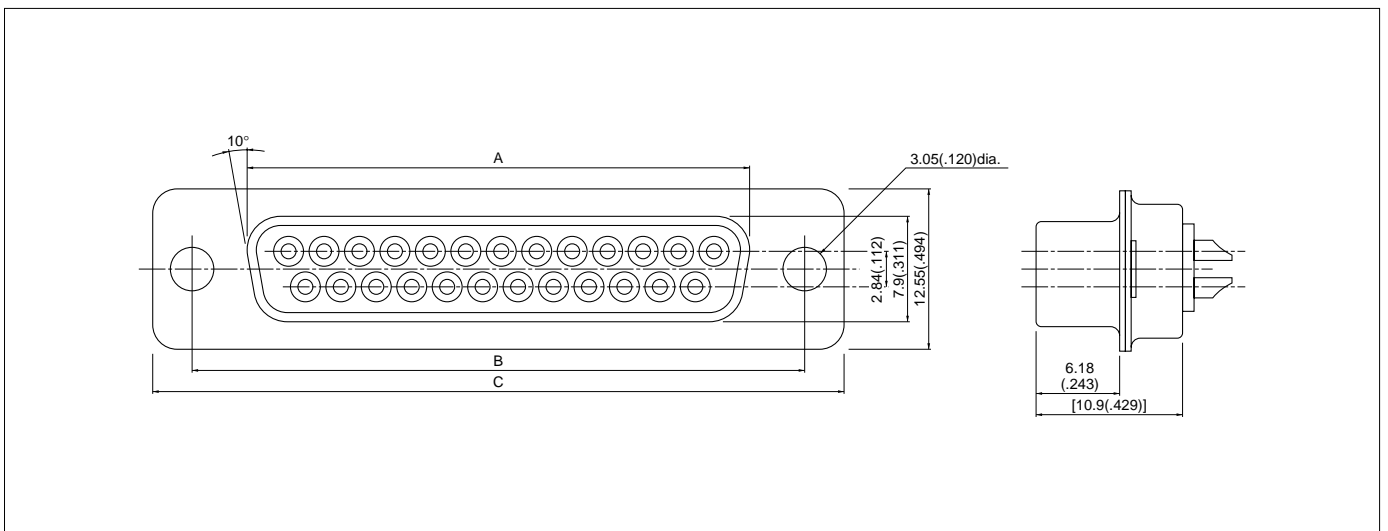

Circuits	Model No.		Dimensions mm(in.)			Q'ty / box
	Gold-plated	Tin-plated	A	B	C	
9	JEZ- 9S	JEZ- 9S-90	16.34(.643)	24.99(.984)	30.80(1.213)	100
15	JAZ-15S	JAZ-15S-90	24.67(.971)	33.33(1.312)	39.14(1.541)	100
25	JBZ-25S	JBZ-25S-90	38.38(1.511)	47.04(1.852)	53.04(2.088)	50
37	JCZ-37S	JCZ-37S-90	54.84(2.159)	63.50(2.500)	69.32(2.729)	50

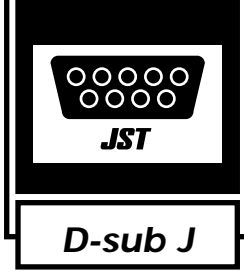

D SUBMINIATURE CONNECTOR J SERIES

Right angle through-hole plug and receptacle

RIGHT ANGLE THROUGH-HOLE PLUG AND RECEPTACLE



Right angle through-hole plug
(with hexagonal lock screw blocks)



Right angle through-hole receptacle
(with rectangular lock screw blocks)



Right angle through-hole receptacle
(with spring lock devices)

Features

- The receptacle contacts are made by high-speed stamping presses. This promotes the uniform elasticity of the twin-contact mating sections and therefore ensures reliable contact even after repeated mating cycles. The solder tails are U-shaped for extra strength.
- Costs are minimized by selective gold plating, high speed stamping presses, and completely automated assembly.
- To ensure complete shielding, a wide variety of grounding adapters are available so that the receptacles can be grounded to different kinds of supporting structures.
- Metric, inch or other lock screw blocks are available for fastening mating plugs.

D SUBMINIATURE CONNECTOR J SERIES

Specifications

Materials

Part name	Material and Finish
Contact of plug	Brass, nickel-undercoated, selective gold-plated or copper-undercoated, tin/lead-plated
Contact of receptacle	Phosphor bronze, nickel-undercoated, selective gold-plated or copper-undercoated, tin/lead-plated
Insulator	Glass-filled PBT, UL94V-0, black
Shell	Mild steel, copper-undercoated, nickel-plated
Hexagonal lock screw block	Mild steel, copper-undercoated, nickel-plated
Rectangular lock screw block	Zinc, copper-undercoated, nickel-plated
Grounding adapter having a 3.2mm(.126") dia. hole	Mild steel, copper-undercoated, nickel-plated
Grounding adapter having an M3 tapped hole	
Grounding adapter having a spring lock lever	Brass, copper-undercoated, tin/lead-plated

Characteristics

Current rating	3A, AC, DC (2.0A AC, DC for 37-circuits)
Voltage rating	250V AC, DC
Temperature range	-40°C to +85°C (including temperature rise in applying electrical current)
Contact resistance	Initial value/15mΩ max. After environmental testing/30mΩ max.
Insulation resistance	5,000MΩ min.
Withstanding voltage	1,000V AC/minute
Applicable PC board thickness	1.6mm(.063")

Note: Contact JST for details.

Standards

UL Recognized E60389 CE Certified LR20812

Model number identification

	J	E	Y	9	S	1A	3	A	12	S1
• Series name										
• Shell size: E, A, B, C										
• Wire connection style: Y... Right angle through-hole style										
• Number of circuits: 9, 15, 25, 37										
• Connector style: P ... Plug, S ... Receptacle										
• Connector construction/Dimensions: Standard J series										
• Types of grounding adapters 0 ... Without grounding adapters 1 ... With grounding adapters having a 3.2mm(.126") dia. hole 2 ... With grounding adapters having an M3 thread 3 ... With grounding adapters having a spring lock device (1) 4 ... With grounding adapters having a spring lock device (2)										
• Types of lock screw blocks A ... With hexagonal lock screw blocks having a No. 4-40 UNC inch thread B ... With hexagonal lock screw blocks having an M2.6 thread C ... With rectangular lock screw blocks having an M2.6 thread D ... Without lock screw blocks E ... Without lock screw blocks, but with grounding adapters having a 3.05mm(.120") dia. hole F ... Without lock screw blocks, but with grounding adapters having a No. 4-40UNC inch thread G ... Without lock screw blocks, but with grounding adapters having an M2.6 thread H ... Without lock screw blocks, but with grounding adapters having an M3 thread										
• Finish Blank ... Gold-plated (flash) 12 ... 0.2micron(8micro-inch) gold-plated 13 ... 0.4micron(16micro-inch) gold-plated 14 ... 0.76micron(30micro-inch) gold-plated 90 ... Tin-plated										
• Spring lock devices Blank...Without spring lock devices S or S1...With spring lock devices										







Note:

- The relationship between number of circuits and shell size is shown below.
9: E, 15: A, 25: B, 37: C
- Contact JST for special plating requirements.
- Contact JST for the Receptacle with spring lock devices. (Not UL recognized nor CSA certified.)

D SUBMINIATURE CONNECTOR J SERIES

Right angle through-hole plug		Type A	Type B																																											
<p>H: Height of the lock screw block (for Types A, B & C)</p> <table border="1"> <thead> <tr> <th rowspan="2">Cir- cuits</th> <th colspan="2">Model No.</th> <th colspan="5">Dimensions mm(in.)</th> <th rowspan="2">Q'ty / box</th> </tr> <tr> <th>gold-plated plug</th> <th>tin-plated plug</th> <th>A</th> <th>B</th> <th>C</th> <th>D</th> <th>E</th> </tr> </thead> <tbody> <tr> <td>9</td> <td>JEY- 9P-1A**</td> <td>JEY- 9P-1A**90</td> <td>16.90(.665)</td> <td>24.99(.984)</td> <td>30.80(1.213)</td> <td>8.1(.319)</td> <td>9.52(.375)</td> <td>100</td> </tr> <tr> <td>15</td> <td>JAY-15P-1A**</td> <td>JAY-15P-1A**90</td> <td>25.25(.994)</td> <td>33.33(1.312)</td> <td>39.14(1.541)</td> <td>8.1(.319)</td> <td>9.52(.375)</td> <td>60</td> </tr> <tr> <td>25</td> <td>JB Y-25P-1A**</td> <td>JB Y-25P-1A**90</td> <td>38.97(1.534)</td> <td>47.04(1.852)</td> <td>53.00(2.087)</td> <td>8.2(.323)</td> <td>9.62(.379)</td> <td>40</td> </tr> </tbody> </table> <p>Note: ** shows the location where a two-digit code (see the table below for codes) should be entered. For example, if a 9-circuit gold-plated plug with hexagonal lock screw blocks having a No.4-40UNC inch thread and without grounding adapters is required, specify the model number as JEY-9P-1A0A.</p>		Cir- cuits	Model No.		Dimensions mm(in.)					Q'ty / box	gold-plated plug	tin-plated plug	A	B	C	D	E	9	JEY- 9P-1A**	JEY- 9P-1A**90	16.90(.665)	24.99(.984)	30.80(1.213)	8.1(.319)	9.52(.375)	100	15	JAY-15P-1A**	JAY-15P-1A**90	25.25(.994)	33.33(1.312)	39.14(1.541)	8.1(.319)	9.52(.375)	60	25	JB Y-25P-1A**	JB Y-25P-1A**90	38.97(1.534)	47.04(1.852)	53.00(2.087)	8.2(.323)	9.62(.379)	40	<p>With hexagonal lock screw blocks (H: 6.3mm (.248")) having a No.4-40UNC inch thread</p>	<p>With hexagonal lock screw blocks (H: 6.3mm (.248")) having an M2.6 thread</p>
Cir- cuits	Model No.		Dimensions mm(in.)					Q'ty / box																																						
	gold-plated plug	tin-plated plug	A	B	C	D	E																																							
9	JEY- 9P-1A**	JEY- 9P-1A**90	16.90(.665)	24.99(.984)	30.80(1.213)	8.1(.319)	9.52(.375)	100																																						
15	JAY-15P-1A**	JAY-15P-1A**90	25.25(.994)	33.33(1.312)	39.14(1.541)	8.1(.319)	9.52(.375)	60																																						
25	JB Y-25P-1A**	JB Y-25P-1A**90	38.97(1.534)	47.04(1.852)	53.00(2.087)	8.2(.323)	9.62(.379)	40																																						
Without grounding adapters		0A	0B																																											
With grounding adapters with a 3.2mm (.126") dia. hole		1A	1B																																											
With grounding adapters with an M3 thread		2A	2B																																											
With grounding adapters with a spring lock device (1)		3A	3B																																											
With grounding adapters with a spring lock device (2)		—	—																																											



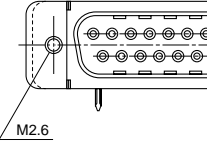
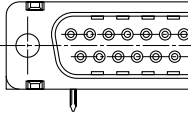
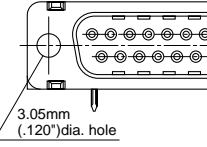
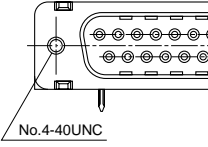
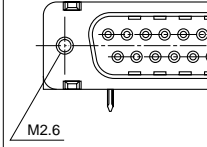
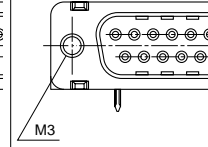



D SUBMINIATURE CONNECTOR J SERIES

Type C	Type D	Type E	Type F	Type G	Type H
					
With rectangular lock screw blocks (H: 6.2mm (.244")) having an M2.6 thread	Without lock screw blocks	Without lock screw blocks E: Grounding adapter has no thread. F, G, H: Grounding adapters have a thread (*1) for securing separately-purchased lock screw blocks (*2)			
		Use a lock screw block of Model number JFS-()S-C1N.	*1: No.4-40UNC inch thread *2: Model number JFS-4S-()1W(M)	*1: M2.6 thread *2: Model number JFS-2.6S-()1W(M)	*1: M3 thread *2: Model number JFS-3S-()1W(M)
					
0C	0D	—	—	—	—
1C	1D	1E	1F	1G	—
2C	2D	2E	2F	2G	—
3C	3D	3E	3F	3G	—
—	—	—	—	—	4H

D SUBMINIATURE CONNECTOR J SERIES

Right angle through-hole receptacle					Type A	Type B																																																				
<p>H: Height of the lock screw block (for Types A, B & C)</p> <table border="1"> <thead> <tr> <th rowspan="2">Cir- cuits</th> <th colspan="2">Model No.</th> <th colspan="5">Dimensions mm(in.)</th> <th rowspan="2">Q'ty / box</th> </tr> <tr> <th>gold-plated receptacle</th> <th>tin-plated receptacle</th> <th>A</th> <th>B</th> <th>C</th> <th>D</th> <th>E</th> </tr> </thead> <tbody> <tr> <td>9</td> <td>JEY- 9S-1A**</td> <td>JEY- 9S-1A**90</td> <td>16.34(.643)</td> <td>24.99(.984)</td> <td>30.81(1.213)</td> <td>8.1(.319)</td> <td>9.52(.375)</td> <td>100</td> </tr> <tr> <td>15</td> <td>JAY-15S-1A**</td> <td>JAY-15S-1A**90</td> <td>24.67(.971)</td> <td>33.32(1.312)</td> <td>39.14(1.541)</td> <td>8.1(.319)</td> <td>9.52(.375)</td> <td>60</td> </tr> <tr> <td>25</td> <td>JBY-25S-1A**</td> <td>JBY-25S-1A**90</td> <td>38.38(1.511)</td> <td>47.04(1.852)</td> <td>53.04(2.088)</td> <td>8.2(.323)</td> <td>9.62(.379)</td> <td>40</td> </tr> <tr> <td>37</td> <td>JCY-37S-1A**</td> <td>JCY-37S-1A**90</td> <td>54.84(2.154)</td> <td>63.50(2.500)</td> <td>69.32(2.729)</td> <td>8.2(.323)</td> <td>9.62(.379)</td> <td>40</td> </tr> </tbody> </table> <p>Note: ** shows the location where a two-digit code (see the table below for codes) should be entered. For example, if a 9-circuit gold-plated plug with hexagonal lock screw blocks having a No.4-40UNC inch thread and without grounding adapters is required, specify the model number as JEY-9S-1A0A.</p>			Cir- cuits	Model No.		Dimensions mm(in.)					Q'ty / box	gold-plated receptacle	tin-plated receptacle	A	B	C	D	E	9	JEY- 9S-1A**	JEY- 9S-1A**90	16.34(.643)	24.99(.984)	30.81(1.213)	8.1(.319)	9.52(.375)	100	15	JAY-15S-1A**	JAY-15S-1A**90	24.67(.971)	33.32(1.312)	39.14(1.541)	8.1(.319)	9.52(.375)	60	25	JBY-25S-1A**	JBY-25S-1A**90	38.38(1.511)	47.04(1.852)	53.04(2.088)	8.2(.323)	9.62(.379)	40	37	JCY-37S-1A**	JCY-37S-1A**90	54.84(2.154)	63.50(2.500)	69.32(2.729)	8.2(.323)	9.62(.379)	40			<p>With hexagonal lock screw blocks (H: 6.3mm (.248")) having a No.4-40UNC inch thread</p>	<p>With hexagonal lock screw blocks (H: 6.3mm (.248")) having an M2.6 thread</p>
Cir- cuits	Model No.			Dimensions mm(in.)					Q'ty / box																																																	
	gold-plated receptacle	tin-plated receptacle	A	B	C	D	E																																																			
9	JEY- 9S-1A**	JEY- 9S-1A**90	16.34(.643)	24.99(.984)	30.81(1.213)	8.1(.319)	9.52(.375)	100																																																		
15	JAY-15S-1A**	JAY-15S-1A**90	24.67(.971)	33.32(1.312)	39.14(1.541)	8.1(.319)	9.52(.375)	60																																																		
25	JBY-25S-1A**	JBY-25S-1A**90	38.38(1.511)	47.04(1.852)	53.04(2.088)	8.2(.323)	9.62(.379)	40																																																		
37	JCY-37S-1A**	JCY-37S-1A**90	54.84(2.154)	63.50(2.500)	69.32(2.729)	8.2(.323)	9.62(.379)	40																																																		
Without grounding adapters					0A	0B																																																				
With grounding adapters with a 3.2mm (.126") dia. hole					1A	1B																																																				
With grounding adapters with an M3 thread					2A	2B																																																				
With grounding adapters with a spring lock device (1)					3A	3B																																																				
With grounding adapters with a spring lock device (2)					—	—																																																				

D SUBMINIATURE CONNECTOR J SERIES

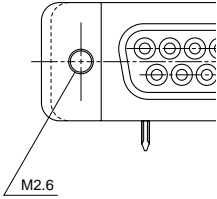
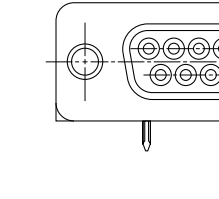
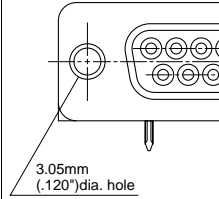
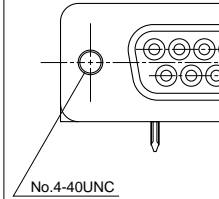
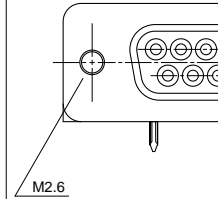
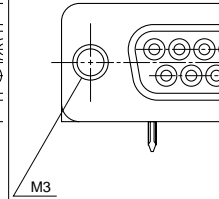
Type C	Type D	Type E	Type F	Type G	Type H
					
With rectangular lock screw blocks (H: 6.2mm (.244")) having an M2.6 thread	Without lock screw blocks	Without lock screw blocks E: Grounding adapter has no thread. F, G, H: Grounding adapters have a thread (*1) for securing separately-purchased lock screw blocks (*2)			
 M2.6		Used a lock screw block [model number JFS-()S-C1N]  3.05mm (.120") dia. hole	*1: No.4-40UNC inch thread *2: Model number JFS-4S-()1W(M)  No.4-40UNC	*1: M2.6 thread *2: Model number JFS-2.6S-()1W(M)  M2.6	*1: M3 thread *2: Model number JFS-3S-()1W(M)  M3
0C	0D	—	—	—	—
1C	1D	1E	1F	1G	—
2C	2D	2E	2F	2G	—
3C	3D	3E	3F	3G	—
—	—	—	—	—	4H

D SUBMINIATURE CONNECTOR J SERIES

PC board layout (viewed from component side)

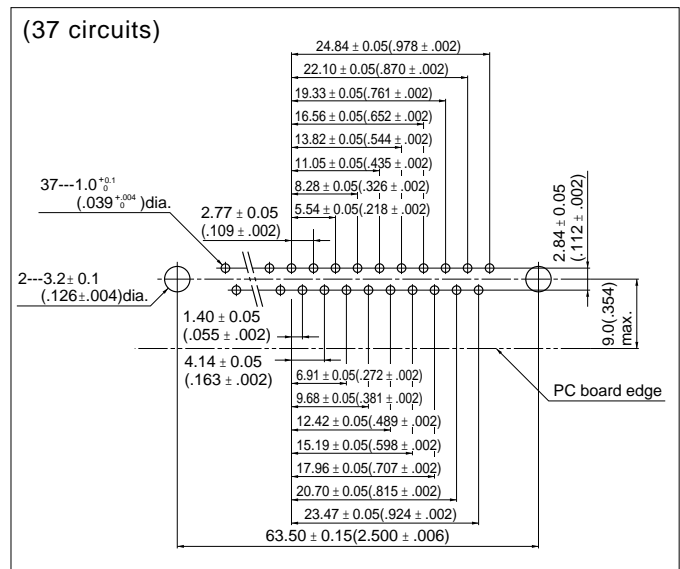
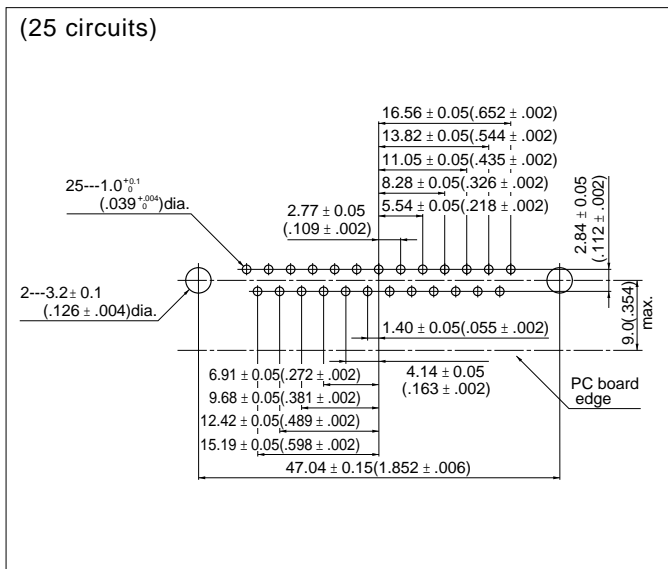
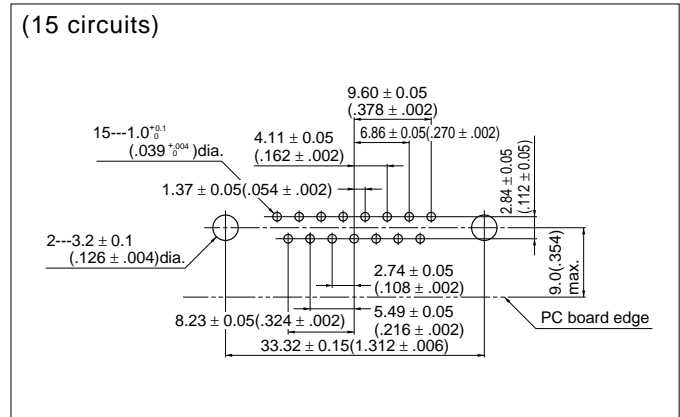
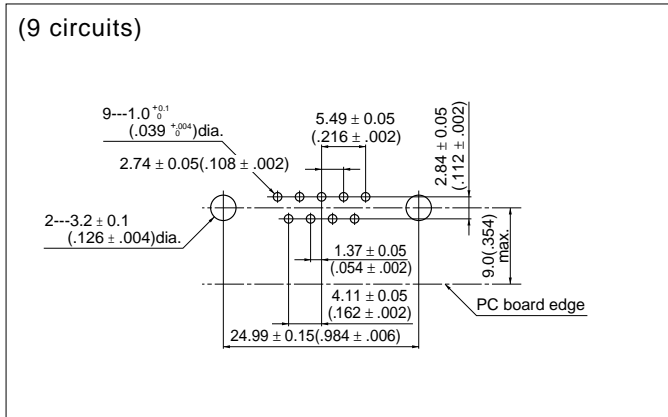

Panel layout

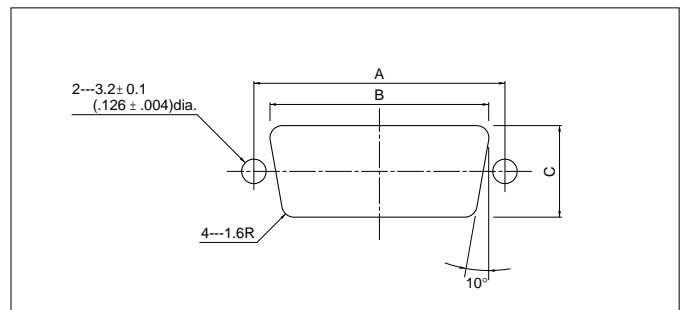
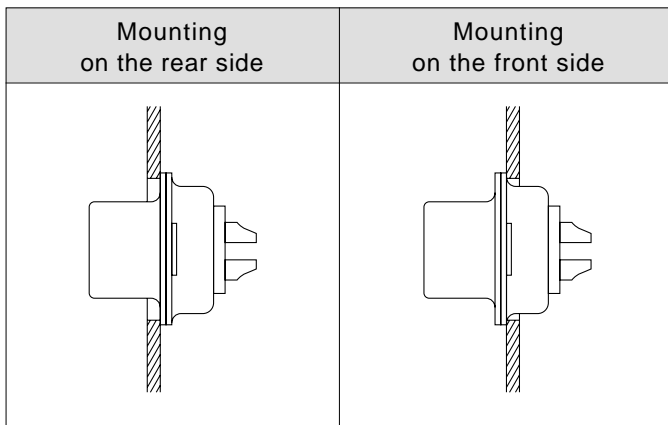

The connector can be mounted either on the front side or on the rear side of the panel as shown above.

Use M2.5 or M2.6 screws for installation.

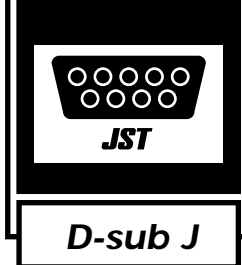

D SUBMINIATURE CONNECTOR J SERIES

Straight through-hole plug and receptacle

STRAIGHT THROUGH-HOLE PLUG AND RECEPTACLE

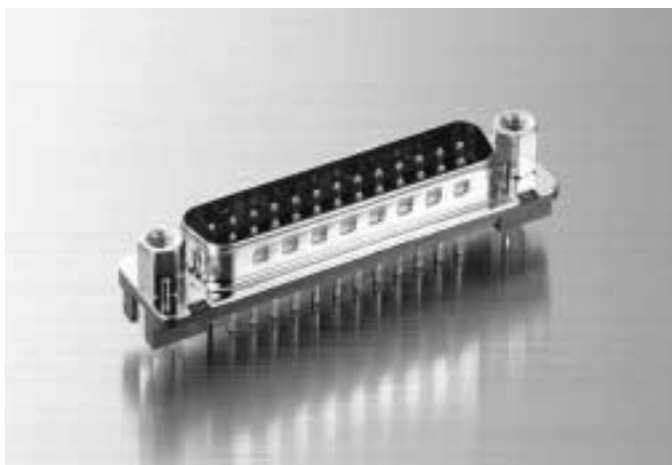

Straight through-hole plug
(with hexagonal lock screw blocks)



Straight through-hole receptacle (without lock screw blocks, but
with grounding adapters having a No.4-40UNC inch thread)

Features

- Three standard types are available with different dimensions between the flange and solder tail: 6mm (.236"), 9mm (.354"), and 12mm (.472").
- The roots of the contact leads are covered to prevent flux from rising into the connector during soldering.
- A grounding adapter with a spring lock device allows the connector to be temporarily secured onto the printed circuit board so that the connector can be soldered easily.

Standards

Recognized E60389

Certified LR20812

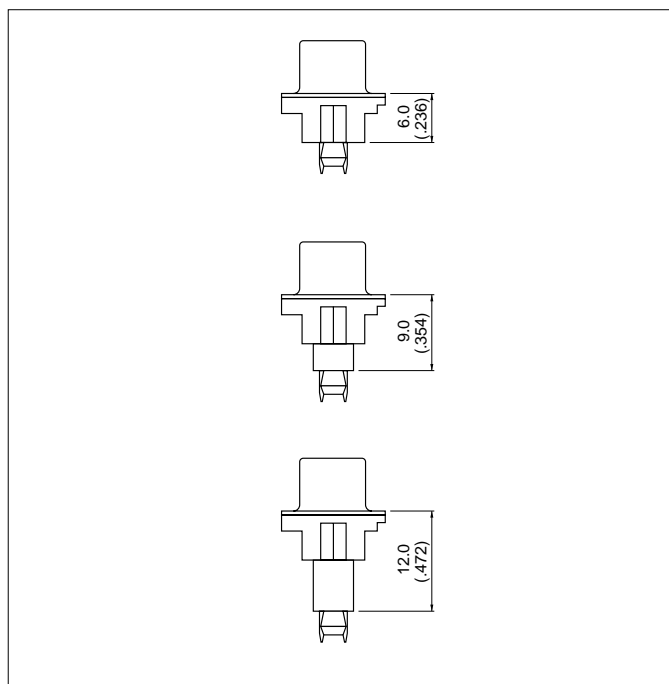

D SUBMINIATURE CONNECTOR J SERIES

Specifications

Materials

Part name		Material and Finish
Contact	Plug	Brass, nickel-undercoated, selective gold-plated
	Receptacle	Phosphor bronze, nickel-undercoated, selective gold-plated
Insulator		Glass-filled PBT, UL94V-0, black
Shell		Mild steel, copper-undercoated, nickel-plated
Hexagonal lock screw block		Mild steel, copper-undercoated, nickel-plated
Grounding adapter with spring lock device		Brass, copper-undercoated, tin/lead-plated

Characteristics

Current rating	3.0A AC, DC
Voltage rating	250V AC, DC
Temperature range	-40°C to +85°C (including temperature rise in applying electrical current)
Contact resistance	Initial value/15mΩ max. After environmental testing/30mΩ max.
Insulation resistance	5,000MΩ min.
Withstanding voltage	1,000V AC/minute
Applicable PC board thickness	1.6mm(.063")

*Contact JST for details.

Straight through-hole plug				Type A																																																
<p>H: Height of the lock screw block (for Types A, B & J)</p> <table border="1"> <thead> <tr> <th rowspan="2">Cir- cuits</th> <th rowspan="2">Dimension between flange and solder tail mm(in.)</th> <th colspan="2">Model No.</th> <th colspan="4">Dimensions mm(in.)</th> <th rowspan="2">Q'ty / box</th> </tr> <tr> <th>Gold-plated (flash) Plug</th> <th>Gold-plated 0.76micron(30micro-inch)</th> <th>A</th> <th>B</th> <th>C</th> <th>D</th> </tr> </thead> <tbody> <tr> <td rowspan="3">9</td> <td>6 (.236)</td> <td>JES- 9P-2A**</td> <td>JES- 9P-2A**14</td> <td rowspan="3">16.90 (.665)</td> <td rowspan="3">24.99 (.984)</td> <td rowspan="3">30.8 (1.213)</td> <td rowspan="3">2.4 (.094)</td> <td rowspan="3">100</td> </tr> <tr> <td>9 (.354)</td> <td>JES- 9P-3A**</td> <td>JES- 9P-3A**14</td> </tr> <tr> <td>12 (.472)</td> <td>JES- 9P-4A**</td> <td>JES- 9P-4A**14</td> </tr> <tr> <td rowspan="3">25</td> <td>6 (.236)</td> <td>JBS-25P-2A**</td> <td>JBS-25P-2A**14</td> <td rowspan="3">38.97 (1.534)</td> <td rowspan="3">47.04 (1.852)</td> <td rowspan="3">53.0 (2.087)</td> <td rowspan="3">2.5 (.098)</td> <td rowspan="3">40</td> </tr> <tr> <td>9 (.354)</td> <td>JBS-25P-3A**</td> <td>JBS-25P-3A**14</td> </tr> <tr> <td>12 (.472)</td> <td>JBS-25P-4A**</td> <td>JBS-25P-4A**14</td> </tr> </tbody> </table>				Cir- cuits	Dimension between flange and solder tail mm(in.)	Model No.		Dimensions mm(in.)				Q'ty / box	Gold-plated (flash) Plug	Gold-plated 0.76micron(30micro-inch)	A	B	C	D	9	6 (.236)	JES- 9P-2A**	JES- 9P-2A**14	16.90 (.665)	24.99 (.984)	30.8 (1.213)	2.4 (.094)	100	9 (.354)	JES- 9P-3A**	JES- 9P-3A**14	12 (.472)	JES- 9P-4A**	JES- 9P-4A**14	25	6 (.236)	JBS-25P-2A**	JBS-25P-2A**14	38.97 (1.534)	47.04 (1.852)	53.0 (2.087)	2.5 (.098)	40	9 (.354)	JBS-25P-3A**	JBS-25P-3A**14	12 (.472)	JBS-25P-4A**	JBS-25P-4A**14	<p>With hexagonal lock screw blocks (H: 6.3mm (.248")) having a No.4-40UNC inch thread</p>			
Cir- cuits	Dimension between flange and solder tail mm(in.)	Model No.				Dimensions mm(in.)				Q'ty / box																																										
		Gold-plated (flash) Plug	Gold-plated 0.76micron(30micro-inch)	A	B	C	D																																													
9	6 (.236)	JES- 9P-2A**	JES- 9P-2A**14	16.90 (.665)	24.99 (.984)	30.8 (1.213)	2.4 (.094)	100																																												
	9 (.354)	JES- 9P-3A**	JES- 9P-3A**14																																																	
	12 (.472)	JES- 9P-4A**	JES- 9P-4A**14																																																	
25	6 (.236)	JBS-25P-2A**	JBS-25P-2A**14	38.97 (1.534)	47.04 (1.852)	53.0 (2.087)	2.5 (.098)	40																																												
	9 (.354)	JBS-25P-3A**	JBS-25P-3A**14																																																	
	12 (.472)	JBS-25P-4A**	JBS-25P-4A**14																																																	
<p>With grounding adapters with a spring lock device</p>				<p>3A</p>																																																





D SUBMINIATURE CONNECTOR J SERIES

Model number identification

• Series name	J	B	S	—	25	P	—	2A	3	F	14	S1
• Shell size: B, E												
• Wire connection type: S ... Straight through-hole type												
• Number of circuits: 9, 25												
• Connector type: P ... Plug S ... Receptacle												
• Connector construction/dimensions: 2A ... 6 mm (.236") from flange to solder tail 3A ... 9 mm (.354") from flange to solder tail 4A ... 12mm (.472") from flange to solder tail												
• Types of grounding adapter: 3 ... Grounding adapter with a spring lock device												
• Types of lock screw block: A ... With hexagonal lock screw blocks having a No. 4-40UNC inch thread B ... With hexagonal lock screw blocks having an M2.6 thread F ... Without lock screw blocks, but with grounding adapters having a No.4-40UNC inch thread G ... Without lock screw blocks, but with grounding adapters having an M2.6 thread H ... Without lock screw blocks, but with grounding adapters having an M3 thread J ... With hexagonal lock screw block having an M3 thread												
• Finish Blank ... Gold-plated(flash) 12 ... 0.2micron(8micro-inch)gold-plated 13 ... 0.4micron(16micro-inch)gold-plated 14 ... 0.76micron(30micro-inch)gold-plated 90 ... Tin-plated												
• Spring lock devices Blank...Without spring lock devices S or S1...With spring lock devices												

Note:

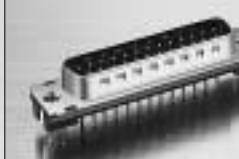
- In the J Series, the number of circuits is determined by the shell size: 9 circuits for E and 25 circuits for B.
- Contact JST for special plating requirements.
- Contact JST for the dimensions between the flange and solder tail other than those listed above.
- Grounding adapters that can secure printed circuit boards are also available.

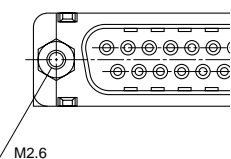
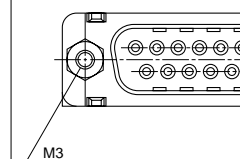
Type B	Type F	Type G	Type H	Type J
				
With hexagonal lock screw blocks (H: 6.3mm(.248")) having an M2.6 thread	Without lock screw blocks F, G, H: Grounding adapters have a thread (*1) for securing separately-purchased lock screw blocks (*2)		With hexagonal lock screw blocks (H: 6.3mm (.248")) having an M3 thread	
	*1: No.4-40UNC inch thread *2: Model number SFS-4S-()1W(M)	*1: M2.6 thread *2: Model number SFS-2.6S-()1W(M)	*1: M3 thread *2: Model number SFS-3S-()1W(M)	
3B	3F	3G	3H	3J

D SUBMINIATURE CONNECTOR J SERIES

Straight through-hole receptacle

H: Height of the lock screw block (for Types A, B & J)

Cir- cuits	Dimension between flange and solder tail mm(in.)	Model No.			Dimensions mm(in.)				Q'ty / box
		Gold-plated (flash) receptacle	Gold-plated 0.76micron(30micro-inch)	Tin-plated	A	B	C	D	
9	6(.236)	JES- 9S-2A**	JES- 9S-2A**14	—	16.34 (.643)	24.99 (.984)	30.8 (1.213)	2.4 (.094)	100
	9(.354)	JES- 9S-3A**	JES- 9S-3A**14	—					
	12(.472)	JES- 9S-4A**	JES- 9S-4A**14	—					
25	6(.236)	JBS-25S-2A**	JBS-25S-2A**14	JBS-25S-2A**90	38.38 (1.511)	47.04 (1.852)	53.0 (2.087)	2.5 (.098)	40
	9(.354)	JBS-25S-3A**	JBS-25S-3A**14	JBS-25S-3A**90					
	12(.472)	JBS-25S-4A**	JBS-25S-4A**14	—					

*Note: ** shows the location where a two-digit code (see the table below for codes) should be entered. For example, if a gold-plated (flash) receptacle with hexagonal lock screw blocks having a No. 4-40UNC inch thread and without grounding adapters whose dimension between flange and solder tail is 6mm(.236") is required, specify the model number as JES-9S-2A3A.*

Type A

With hexagonal lock screw blocks (H: 6.3mm (.248")) having a No.4-40UNC inch thread

With grounding adapters with a spring lock device

6 mm (.236") type

9 mm (.354") type

12mm (.472") type

3A

PC board layout

(9-circuits)

(25- circuits)

D SUBMINIATURE CONNECTOR J SERIES

Type B	Type F	Type G	Type H	Type J
With hexagonal lock screw blocks (H: 6.3mm (.248")) having an M2.6 thread	Without lock screw blocks F, G, H: Grounding adapters have a thread (*1) for securing separately-purchased lock screw blocks (*2)			With hexagonal lock screw blocks (H: 6.3mm (.248")) having an M3 thread
 M2.6	*1: No.4-40UNC inch thread *2: Model number SFS-4S-()1W(M) No.4-40UNC	*1: M2.6 thread *2: Model number SFS-2.6S-()1W(M) M2.6	*1: M3 thread *2: Model number SFS-3S-()1W(M) M3	 M3
3B	3F	3G	3H	3J

Panel layout

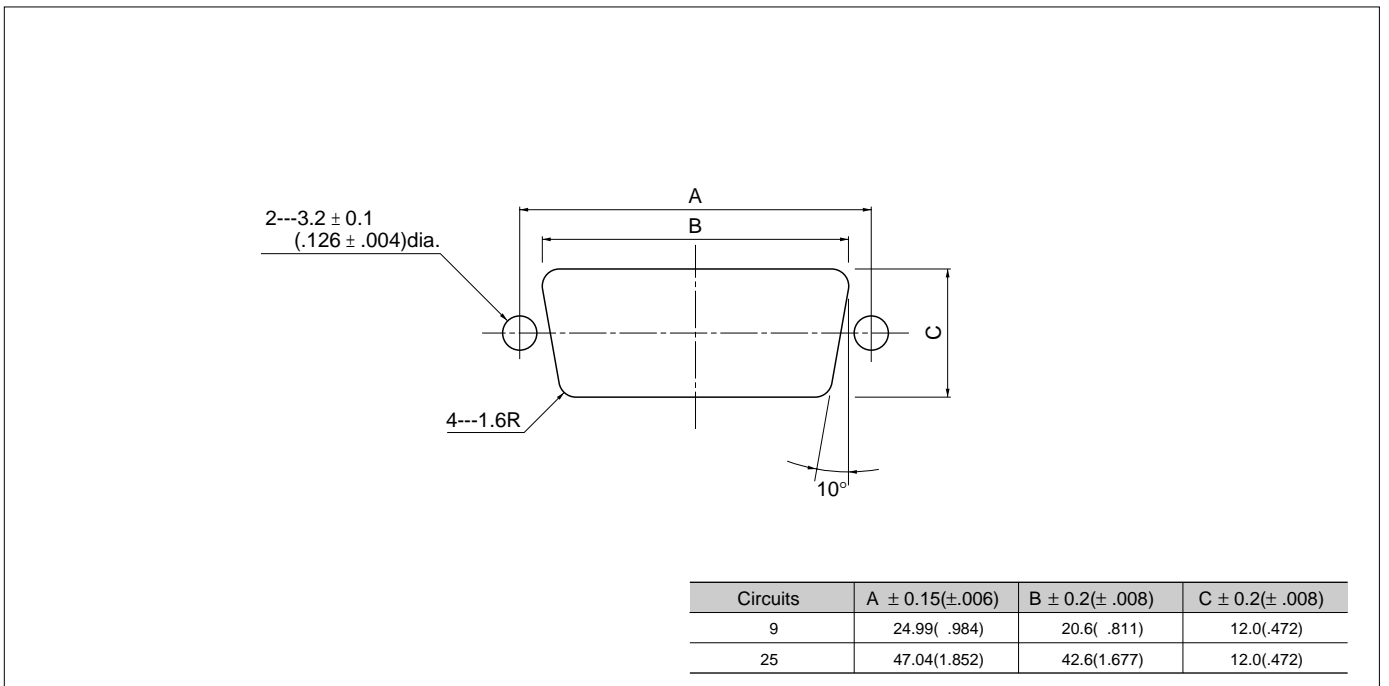

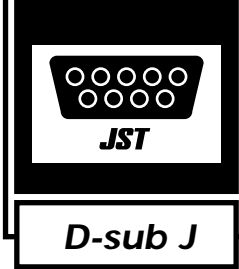

D SUBMINIATURE CONNECTOR J SERIES

Crimp style plug and receptacle

CRIMP STYLE PLUG AND RECEPTACLE



Pin contact
Crimp style plug



Socket contact
Crimp style receptacle

Features

- The contacts of this plug are formed by high-speed stamping presses into continuous strips that can be automatically fed into our compact crimping machines. Much less time is required to assemble CRT and RS-232C round cables using this plug than when soldering connections.
- The contacts in this connector are selectively gold-plated. Moreover, JST's advanced technological knowledge and experience are fully utilized to significantly reduce production costs.
- The dimples in the connector shell provide the ground connection and are important factors in preventing electromagnetic interference. The contact has a lance that can be visually checked during assembly. This assures accurate assembly and reduces defects.

Specifications

Materials

Connector	Part name	Material and Finish
Plug	Pin contact	Brass, nickel-undercoated, selective gold-plated or copper-undercoated, tin-plated
	Insulator	Glass-filled PBT, UL94V-0, black
	Shell	Mild steel, copper-undercoated, tin/lead-plated
Receptacle	Socket contact	Phosphor bronze, nickel-undercoated, selective gold-plated
	Insulator	Glass-filled PBT, UL94-0, black
	Shell	Mild steel, copper-undercoated, tin/lead-plated

Characteristics

Current rating	3A, AC, DC (2A for 37-circuits)(AWG #20)
Voltage rating	250V AC, DC
Temperature range	-40°C to +85°C (including temperature rise in applying electrical current)
Contact resistance	Initial value/15mΩ max. After environmental testing/30mΩ max.
Insulation resistance	5,000MΩ min.
Withstanding voltage	1,000V AC/minute

Note: Contact JST for details.

Model number identification

Contact

Series name: J — S P 2 1 40

- Series name: J — S P 2 1 40
- Product shape: S ... Chain, B ... Loose piece
- Type of contact: P ... Pin contact, S ... Socket contact
- Applicable wire: 1 ... AWG #24 to #20, 2 ... AWG #28 to #24
- Material: 1 ... Brass(Pin contact), 3 ... Phosphor bronze(Socket contact)
- Finish:
 - 40 ... Gold-plated (flash)
 - 42 ... 0.2micron(8micro-inch) gold-plated
 - 43 ... 0.4micron(16micro-inch)gold-plated
 - 44 ... 0.76micron(30micro-inch) gold-plated
 - 90 ... Tin-plated

Note: Contact JST for special plating requirements.

Housing

Series name: J E C — 9 P

- Series name: J E C — 9 P
- Shell size: E, A, B, C
- Wire connection style: C ... crimp style
- Number of circuits: 9, 15, 25, 37
- Connector style: P ... Plug, S ... Receptacle

Note: The relationship between number of circuits and shell size is shown below.
9: E, 15: A, 25: B, 37: C

Standards

UL Recognized E60389

RoHS Certified LR20812

D SUBMINIATURE CONNECTOR J SERIES

Pin contact (for plug housing)

Socket contact (for receptacle housing)

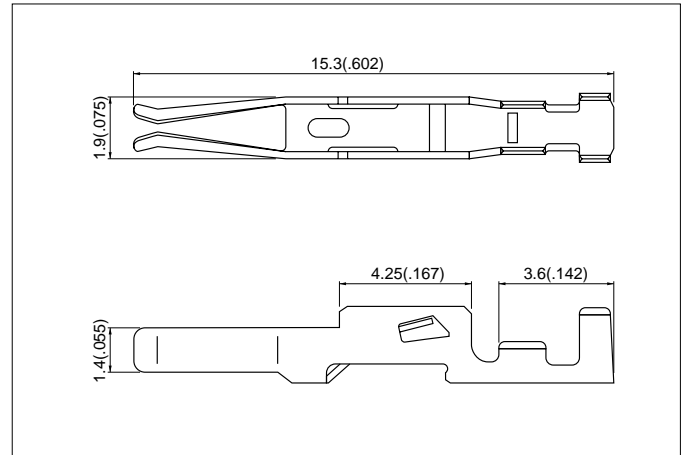
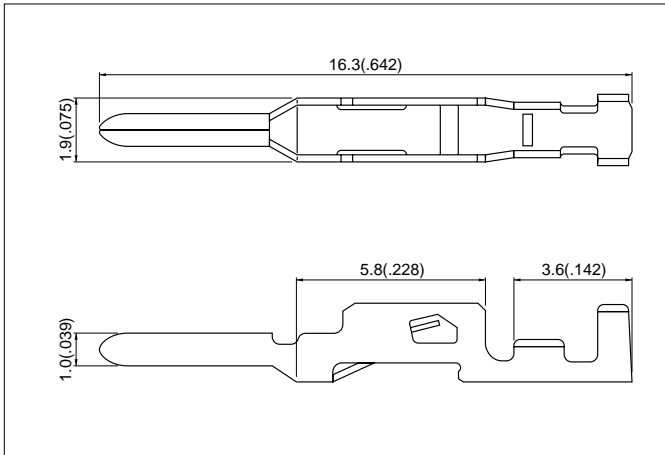

Model No.			Applicable wire		Q'ty / reel
Pin contact		Socket contact	AWG #	Insulation O.D. mm(in.)	
Gold-plated	Tin-plated	Gold-plated	#24 to #20	1.1 to 1.8mm(.043" to .071")	10,000
*J-SP1140	*J-SP1190	*J-SS1340			
J-SP2140	J-SP2190	J-SS2340	#28 to #24	0.9 to 1.3mm(.035" to .051")	

Note: Models marked * are not CSA certified.

Plug housing

Receptacle housing

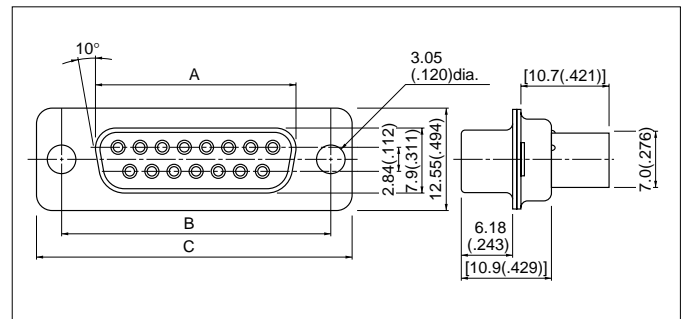
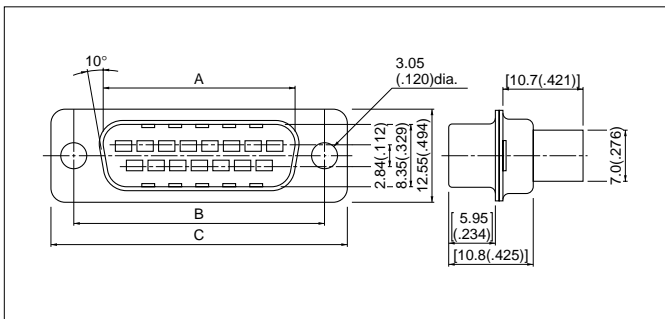

Cir- cuits	Model No.	Dimensions mm(in.)			Q'ty / box
		A	B	C	
9	JEC- 9P	16.92(.666)	24.99(.984)	30.80(1.213)	100
15	JAC-15P	25.25(.994)	33.32(1.312)	39.14(1.541)	100
25	JBC-25P	38.97(1.534)	47.04(1.852)	53.04(2.088)	50
37	JCC-37P	55.43(2.182)	63.50(2.500)	69.32(2.729)	50

Cir- cuits	Model No.	Dimensions mm(in.)			Q'ty / box
		A	B	C	
9	JEC- 9S	16.34(.643)	24.99(.984)	30.80(1.213)	100
15	JAC-15S	24.67(.971)	33.33(1.312)	39.14(1.541)	100
25	JBC-25S	38.38(1.511)	47.04(1.852)	53.04(2.088)	50

Applicator for the semi-automatic press AP-K2N

Contact	Crimp applicator MKS-L		Compact crimp applicator MKS-LS		Strip-crimp applicator MKS-SC
	with safety cover	without safety cover	with safety cover	without safety cover	with safety cover
J-SP1***	APLMK J-SP/SS1	APLNC J-SP/SS1	-	-	APLSC J-SP/SS1
J-SS1***	APLMK J-SP/SS1	APLNC J-SP/SS1	-	-	APLSC J-SP/SS1
J-SP2***	APLMK J-SP/SS2	APLNC J-SP/SS2	-	-	APLSC J-SP/SS2
J-SS2***	APLMK J-SP/SS2	APLNC J-SP/SS2	-	-	APLSC J-SP/SS2