

ELV. RoHS COMPLIANT

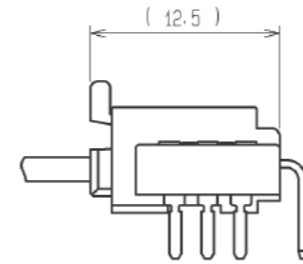

MATED CONNECTORS

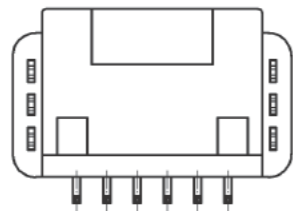
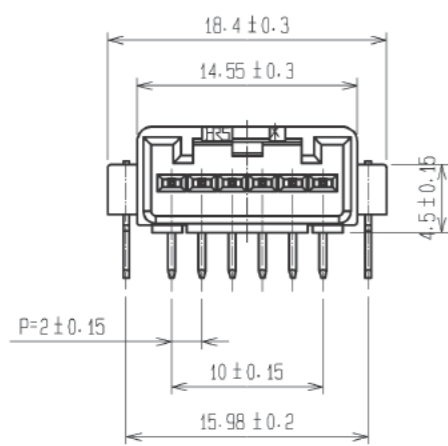
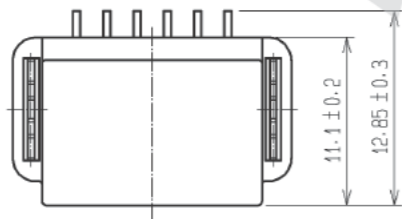
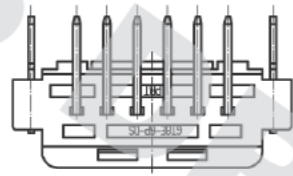
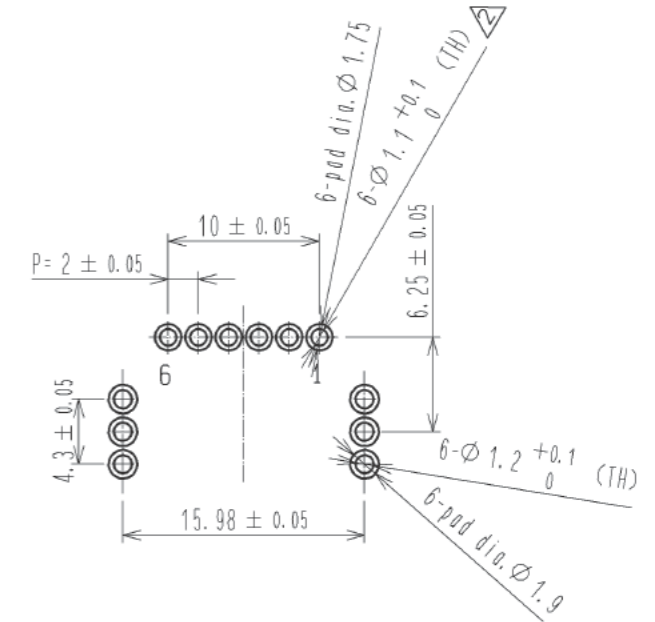

RECOMMENDED PC BOARD PATTERN (CONNECTOR SIDE) AND PIN No.

⚠ Drawing for packing.

Note1. Eight trays(A, B) to be piled in turn. Top(the ninth step) is an empty tray. (One tray includes 136 pcs of products. One bundle: 136×8=1088 pcs.)

Note2. One K-1 box includes 2176 pcs. (1088×2=2176)

Note3. The size of the tray see below.

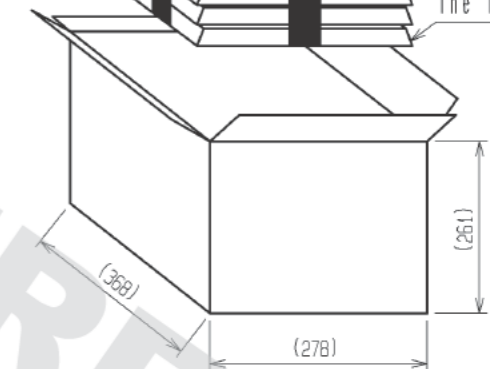
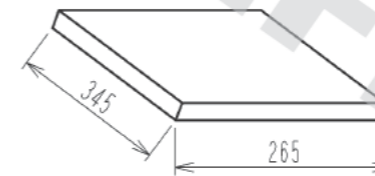
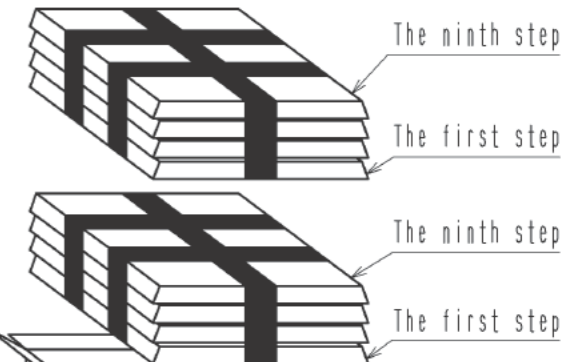

2	BRASS	TIN PLATING						
1	PBT	BLACK						
NO.	MATERIAL	FINISH .	REMARKS	NO.	MATERIAL	FINISH .	REMARKS	
UNITS	mm	SCALE	2 : 1	COUNT	1	DESCRIPTION OF REVISIONS	DESIGNED	CHECKED
						DIS-T-002880	YT. HAYAKAWA	NH. NAKATA
							DATE	12. 08. 29
APPROVED : KS. SATOH		08. 07. 28		DRAWING NO.		EDC3-166697-00		
CHECKED : AR. SHIRAI		08. 07. 28		PART NO.		GT8E-6P-DS		
DESIGNED : YN. KADOTA		08. 07. 28		CODE NO.		CL758-0042-5-00		
DRAWN : YN. KADOTA		08. 07. 28						

DRAWING FOR REFERENCE: This is subject to change without notice 05/31/2013