

# HDC34-18 ✓ ACTIVE

DEUTSCH | DEUTSCH HD, DEUTSCH HD30

TE Internal #: HDC34-18

Automotive Connector Caps & Covers, Dust Cap, Aluminum, Wire-to-Wire, 21 / 20 / 14 Position, -67 – 257 °F [-55 – 125 °C], DEUTSCH HD30

[View on TE.com >](#)



Connectors > Automotive Connectors > Connector Accessories > Connector Caps & Covers > DEUTSCH HD30 PLUG PROTECTIVE CAPS

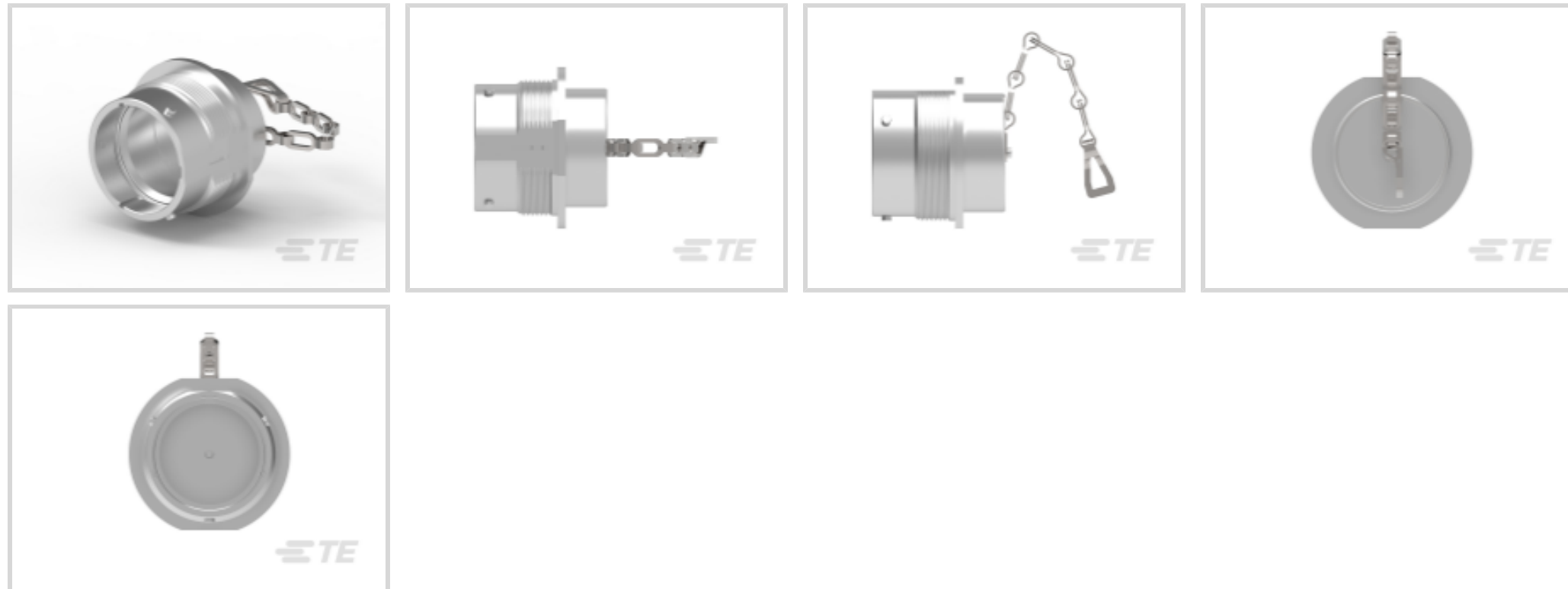

Protection & Strain Relief Accessory Type: **Dust Cap**

Strain Relief: **Without**

Primary Product Material: **Aluminum**

Connector System: **Wire-to-Wire**

Number of Positions: **6, 8, 14, 20, 21**

[All DEUTSCH HD30 PLUG PROTECTIVE CAPS \(4\)](#)

## Features

### Product Type Features

Protection & Strain Relief Accessory Type	Dust Cap
Connector System	Wire-to-Wire
Sealable	No
Connector & Contact Terminates To	Wire & Cable

### Configuration Features

Number of Positions	6, 8, 14, 20, 21
---------------------	------------------

### Body Features

Primary Product Material	Aluminum
--------------------------	----------

### Mechanical Attachment

Strain Relief	Without
---------------	---------

### Usage Conditions

Compatible With Connector Style	Plug
---------------------------------	------



Operating Temperature (Max)	125 °C[257 °F]
Operating Temperature Range	-55 – 125 °C[-67 – 257 °F]

### Industry Standards

Degree of Protection	Not Tested
----------------------	------------

### Packaging Features

Packaging Quantity	1
Packaging Method	Box

### Other

Serviceable	Yes
-------------	-----

## Product Compliance

[For compliance documentation, visit the product page on TE.com>](#)

EU RoHS Directive 2011/65/EU	Compliant
EU ELV Directive 2000/53/EC	Compliant
China RoHS 2 Directive MIIT Order No 32, 2016	No Restricted Materials Above Threshold
EU REACH Regulation (EC) No. 1907/2006	Current ECHA Candidate List: JUNE 2022 (224) Candidate List Declared Against: JUNE 2022 (224) Does not contain REACH SVHC
Halogen Content	Low Halogen - Br, Cl, F, I < 900 ppm per homogenous material. Also BFR/CFR/PVC Free
Solder Process Capability	Not reviewed for solder process capability

#### Product Compliance Disclaimer

This information is provided based on reasonable inquiry of our suppliers and represents our current actual knowledge based on the information they provided. This information is subject to change. The part numbers that TE has identified as EU RoHS compliant have a maximum concentration of 0.1% by weight in homogenous materials for lead, hexavalent chromium, mercury, PBB, PBDE, DBP, BBP, DEHP, DIBP, and 0.01% for cadmium, or qualify for an exemption to these limits as defined in the Annexes of Directive 2011/65/EU (RoHS2). Finished electrical and electronic equipment products will be CE marked as required by Directive 2011/65/EU. Components may not be CE marked. Additionally, the part numbers that TE has identified as EU ELV compliant have a maximum concentration of 0.1% by weight in homogenous materials for lead, hexavalent chromium, and mercury, and 0.01% for cadmium, or qualify for an exemption to these limits as defined in the Annexes of Directive 2000/53/EC (ELV). Regarding the REACH Regulation, the information TE provides on SVHC in articles for this part number is based on the latest European Chemicals Agency (ECHA) 'Guidance on requirements for substances in articles' posted at this URL: <https://echa.europa.eu/guidance-documents/guidance-on-reach>

## Compatible Parts



### Also in the Series | DEUTSCH HD

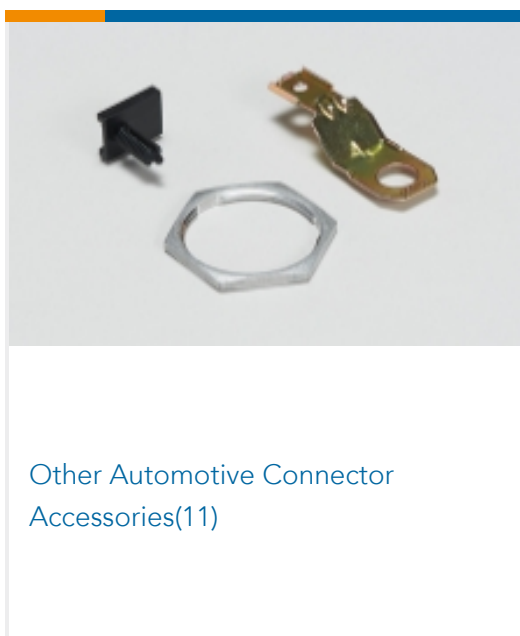
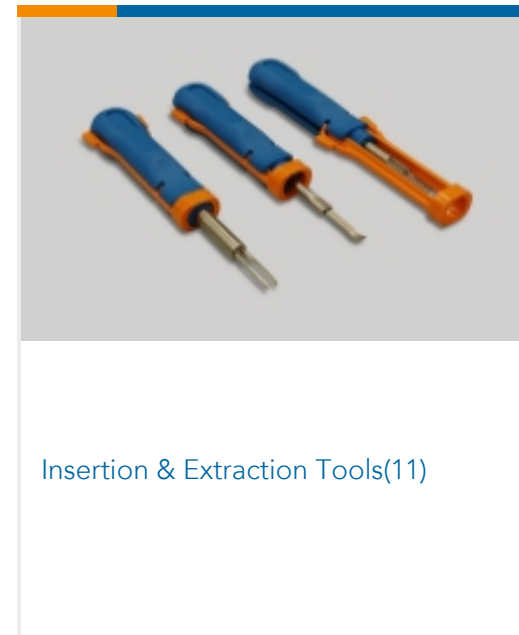
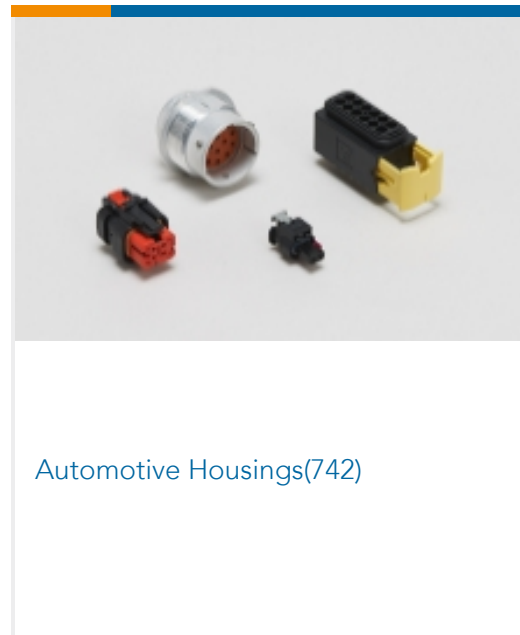
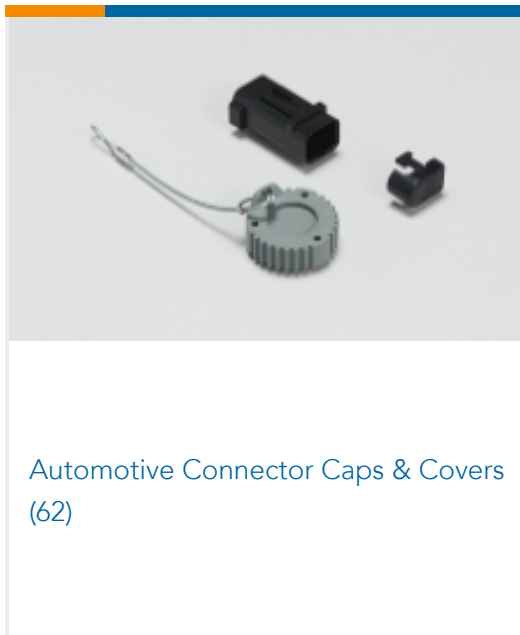

### Also in the Series | DEUTSCH HD30

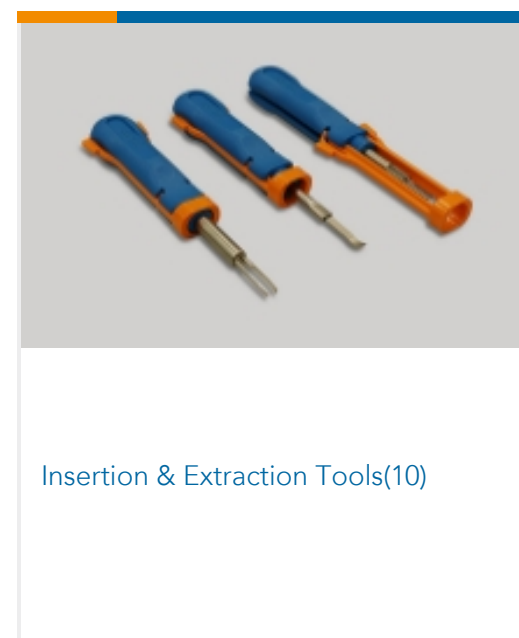
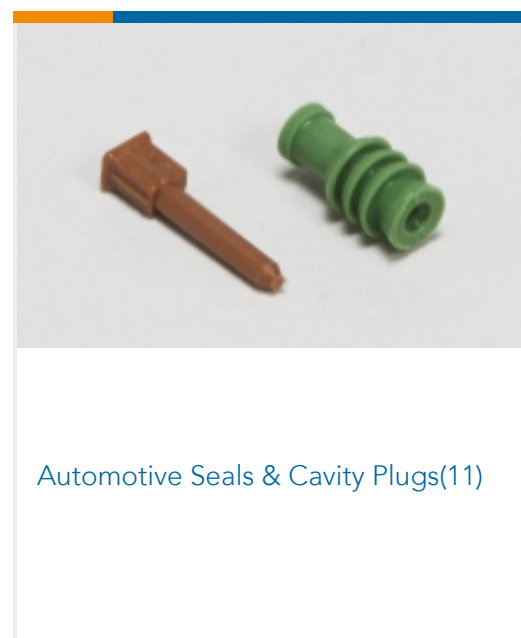
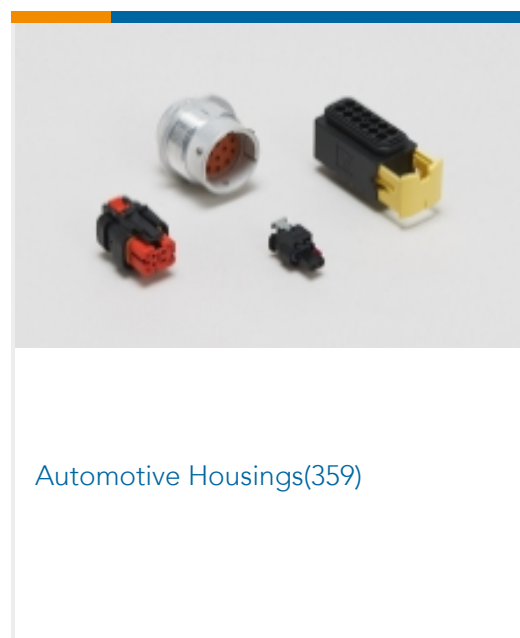
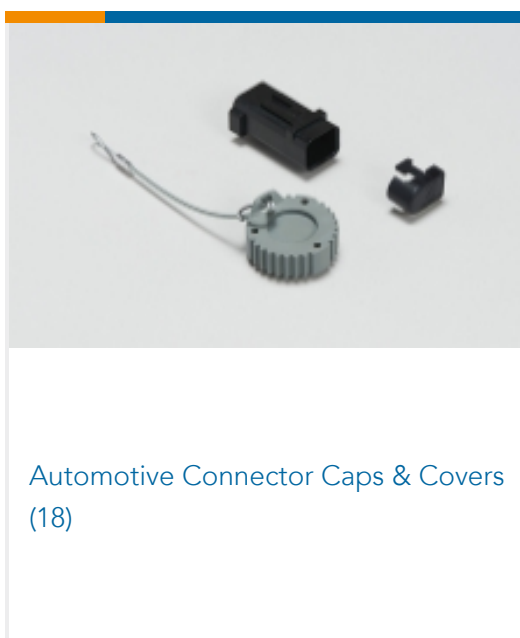



Other Automotive Connector Accessories(6)

## Customers Also Bought



TE Part #HDB36-18-14SN-059  
DEUTSCH HD30 HOUSINGS



TE Part #63539-1  
250 FASTON REC 14-10 AWG TPBR



TE Part #1-2232892-4  
4P MONOPLUG 2.5



TE Part #5004-002-2405  
DUST CAP, 24SZ, REC, BLK, HDBOX



TE Part #HD44-24-21PE  
KT RC HD30 24 SHL 21 WY E SEAL



TE Part #HD46-24-21SE-059  
KT PL HD30 24 SHL 21 WY E SEAL  
CLMP



TE Part #YHD44-18-6SN-00000  
HD30 18SHL 6WY NSEAL KIT

## Documents

### Product Drawings

DUST CAP, 18SZ, PLG, AL, LANYARD, HD30

English

### CAD Files

3D PDF

3D

Customer View Model

[ENG\\_CVM\\_CVM\\_HDC34-18\\_B.2d\\_dxf.zip](#)

English

Customer View Model

[ENG\\_CVM\\_CVM\\_HDC34-18\\_B.3d\\_igs.zip](#)

English

Customer View Model

[ENG\\_CVM\\_CVM\\_HDC34-18\\_B.3d\\_stp.zip](#)

English

By downloading the CAD file I accept and agree to the [Terms and Conditions](#) of use.



---

**Datasheets & Catalog Pages**

[ICT Terminals and Connectors Catalogue](#)

English

[CONNECTOR SELECTOR](#)

English

---

**Product Specifications**

[Application Specification](#)

English

---

**Product Environmental Compliance**

[Product Compliance](#)

English

[Product Compliance](#)

English