

miniSMDC Series

PolySwitch® Resettable PPTCs

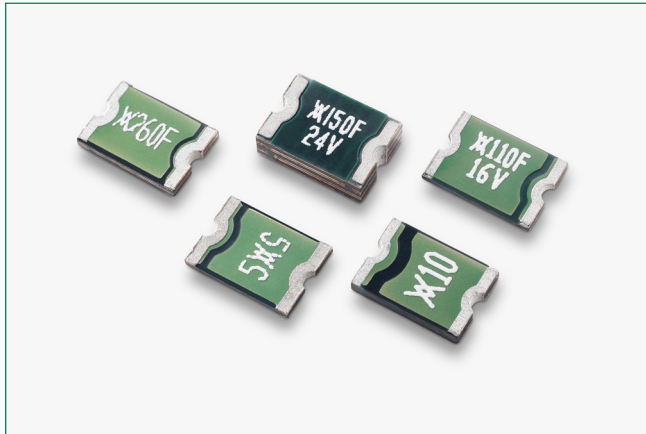

Description

The miniSMDC series provides surface mount overcurrent protection for applications where space is at a premium and resettable protection is desired.

Features

- Broadest range of resettable devices available in industry
- Low resistance
- Small 1812 footprint
- Fast time-to-trip
- RoHS compliant, lead-free and halogen-free
- Recognized to UL 1434
- Conforms to IEC 60730-1, Clauses 12, 15, 16, 17, J15 and J17

Additional Information



Resources



Accessories



Samples

Applications

- Mobile Electronics
- Mobile Batteries
- Computer
- Portable electronics
- Multimedia
- Game machines
- Telephone and broadband
- Automotive
- Industrial controls
- Battery

Additional Information

Agency	Agency File Number
	E74889
	78165
	72161779, 50276261

miniSMDC Series

PolySwitch® Resettable PPTCs

Electrical Characteristics

Part Number	Ordering Part Number	I_H	I_T	V_{MAX}	I_{MAX}	$P_{D MAX}$	Max Time-to-trip		R_{MIN}	R_{1MAX}
		(A)	(A)	(V _{DC})	(A)	(W)	(A)	(s)	(Ω)	(Ω)
miniSMDC Series — Size 1812										
miniSMDC010F	RF1864-000	0.10	0.30	60	40	0.75	0.50	5.00	0.70	12.70
miniSMDC014F	RF1334-000	0.14	0.28	60	10	0.75	8.00	0.008	1.50	6.00
miniSMDC020F	RF1335-000	0.20	0.40	30	10	0.80	8.00	0.02	0.60	3.30
miniSMDC030F	RF1335-000	0.30	0.60	30	40	0.80	8.00	0.10	0.20	1.75
miniSMDC050F	RF1403-000	0.50	1.00	24	100	0.80	8.00	0.15	0.15	1.00
miniSMDC075F	RF1404-000	0.75	1.50	13.2	100	1.00	8.00	0.20	0.11	0.45
miniSMDC075F/24	RF1403-000	0.75	1.50	24	40	0.80	8.00	0.30	0.09	0.29
miniSMDC075F/33	RF1403-000	0.75	1.60	33	100	1.00	8.00	1.00	0.11	0.39
miniSMDC100F	RF1405-000	1.10	2.20	8	100	1.20	8.00	0.30	0.04	0.21
miniSMDC110F	RF1406-000	1.10	2.20	8	100	1.20	8.00	0.30	0.04	0.21
miniSMDC110F/16	RF1405-000	1.10	2.20	16	100	0.80	8.00	0.30	0.06	0.18
miniSMDC110F/24	RF1405-000	1.10	2.20	24	20	0.80	8.00	0.50	0.06	0.18
miniSMDC125F	RF1407-000	1.25	2.50	6	100	0.80	8.00	0.40	0.05	0.14
miniSMDC125F/16	RF1406-000	1.25	2.50	16	100	0.80	8.00	0.40	0.05	0.14
miniSMDC150F	RF1408-000	1.50	3.00	6	100	0.80	8.00	0.50	0.04	0.11
miniSMDC150F/12	RF1407-000	1.50	2.80	12	100	0.80	8.00	0.50	0.04	0.11
miniSMDC150F/16	RF1407-000	1.50	2.80	16	100	0.80	8.00	0.50	0.04	0.11
miniSMDC150F/24	RF1407-000	1.50	3.00	24	20	1.00	8.00	1.50	0.04	0.12
miniSMDC160F	RF2487-000	1.60	3.20	9	100	0.80	8.00	1.00	0.03	0.10
miniSMDC200F	RF3101-000	2.00	4.00	8	100	1.00	8.00	5.00	0.020	0.070
miniSMDC200F/16	RF3101-000	2.00	4.00	16	40	1.20	8.00	5.00	0.020	0.085
miniSMDC260F	RF3895-000	2.60	5.00	6	100	1.00	8.00	5.00	0.015	0.043
miniSMDC260F/12	RF3101-000	2.60	5.00	12	100	1.00	8.00	5.00	0.015	0.047
miniSMDC260F/13.2	RF3101-000	2.60	5.00	13.2	100	1.20	8.00	5.00	0.015	0.050
miniSMDC260F/16	RF3895-000	2.60	5.00	16	100	1.20	8.00	5.00	0.015	0.050
miniSMDC300F	RF3895-000	3.00	6.00	6	100	1.00	8.00	5.00	0.011	0.036

Notes:

- I_H : Hold current: maximum current device will pass without interruption in 20°C still air.
- I_T : Trip current: minimum current that will switch the device from low resistance to high resistance in 20°C still air.
- V_{MAX} : Maximum continuous voltage device can withstand without damage at rated current.

- I_{MAX} : Maximum fault current device can withstand without damage at rated voltage.
- P_D : Power dissipated from device when in the tripped state in 20°C still air.
- R_{MIN} : Minimum resistance of device as supplied at 20°C unless otherwise specified.
- R_{1MAX} : Maximum resistance measured one hour post-trip or post-reflow at 20°C.

Temperature Derating

Part Number	Maximum Ambient Temperature										
	-40°C	-20°C	0°C	20°C	25°C	40°C	50°C	60°C	70°C	80°C	85°C
Hold Current (A)											
miniSMDC Series — Size 1812											
miniSMDC010F	0.17	0.15	0.13	0.11	0.10	0.09	0.08	0.07	0.06	0.05	0.04
miniSMDC014F	0.23	0.20	0.17	0.14	0.13	0.11	0.10	0.09	0.07	0.06	0.05
miniSMDC020F	0.30	0.27	0.23	0.20	0.19	0.17	0.15	0.13	0.12	0.10	0.09
miniSMDC030F	0.49	0.44	0.39	0.32	0.30	0.27	0.24	0.22	0.18	0.16	0.14
miniSMDC050F	0.59	0.57	0.55	0.50	0.48	0.45	0.43	0.35	0.30	0.25	0.23
miniSMDC075F	1.10	0.99	0.87	0.75	0.72	0.63	0.57	0.49	0.45	0.39	0.35
miniSMDC075F/24	1.50	1.25	1.00	0.75	0.73	0.65	0.60	0.55	0.50	0.45	0.43
miniSMDC075F/33	1.09	0.98	0.87	0.77	0.75	0.66	0.61	0.55	0.50	0.45	0.42
miniSMDC100F	1.60	1.45	1.28	1.10	1.07	0.92	0.83	0.71	0.66	0.57	0.52
miniSMDC110F	1.60	1.45	1.28	1.10	1.07	0.92	0.83	0.71	0.66	0.57	0.52
miniSMDC110F/16	1.68	1.49	1.30	1.10	1.05	0.92	0.83	0.75	0.64	0.55	0.50
miniSMDC110F/24	2.00	1.70	1.40	1.10	1.06	0.95	0.88	0.80	0.73	0.65	0.61
miniSMDC125F	2.00	1.69	1.47	1.25	1.17	1.03	0.92	0.90	0.69	0.58	0.53
miniSMDC125F/16	2.00	1.69	1.47	1.25	1.17	1.03	0.92	0.90	0.69	0.58	0.53
miniSMDC150F	2.30	2.05	1.77	1.50	1.44	1.23	1.09	0.95	0.82	0.68	0.61
miniSMDC150F/12	2.40	2.10	1.80	1.50	1.44	1.25	1.13	1.00	0.88	0.75	0.69
miniSMDC150F/16	2.40	2.10	1.80	1.50	1.44	1.25	1.13	1.00	0.88	0.75	0.69
miniSMDC150F/24	2.10	1.90	1.70	1.50	1.44	1.25	1.13	1.00	0.88	0.75	0.69
miniSMDC160F	2.50	2.19	1.89	1.60	1.53	1.31	1.16	1.10	0.95	0.79	0.71
miniSMDC200F	2.60	2.44	2.22	2.00	1.96	1.78	1.67	1.50	1.45	1.34	1.29
miniSMDC200F/16	3.07	2.74	2.40	2.07	2.00	1.74	1.57	1.40	1.24	1.07	0.99
miniSMDC260F	3.40	3.16	2.80	2.60	2.54	2.32	2.18	2.00	1.90	1.76	1.69
miniSMDC260F/12	3.40	3.16	3.00	2.60	2.54	2.32	2.18	2.00	1.90	1.76	1.69
miniSMDC260F/13.2	3.40	3.16	3.00	2.60	2.54	2.32	2.18	2.00	1.90	1.76	1.69
miniSMDC260F/16	3.50	3.20	3.00	2.60	2.53	2.30	2.15	2.00	1.85	1.70	1.63
miniSMDC300F	4.13	3.75	3.33	3.02	3.00	2.70	2.54	2.35	2.22	2.06	1.98

miniSMDC Series

PolySwitch® Resettable PPTCs

Typical Time-to-Trip Curves at 20°C

- miniSMDCxxxF**
- A = miniSMDC010F
 - miniSMDC014F
 - B = miniSMDC020F
 - C = miniSMDC030F
 - D = miniSMDC050F
 - E = miniSMDC075F
 - F = miniSMDC075F/24
 - G = miniSMDC075F/33
 - H = miniSMDC100F
 - miniSMDC110F
 - I = miniSMDC110F/16
 - J = miniSMDC110F/24
 - K = miniSMDC125F
 - L = miniSMDC125F/16
 - M = miniSMDC150F
 - miniSMDC150F/12
 - N = miniSMDC150F/16
 - O = miniSMDC150F/24
 - P = miniSMDC160F
 - Q = miniSMDC200F
 - R = miniSMDC200F/16
 - S = miniSMDC260F
 - T = miniSMDC260F/12
 - miniSMDC260F/13.2
 - miniSMDC260F/16
 - U = miniSMDC300F

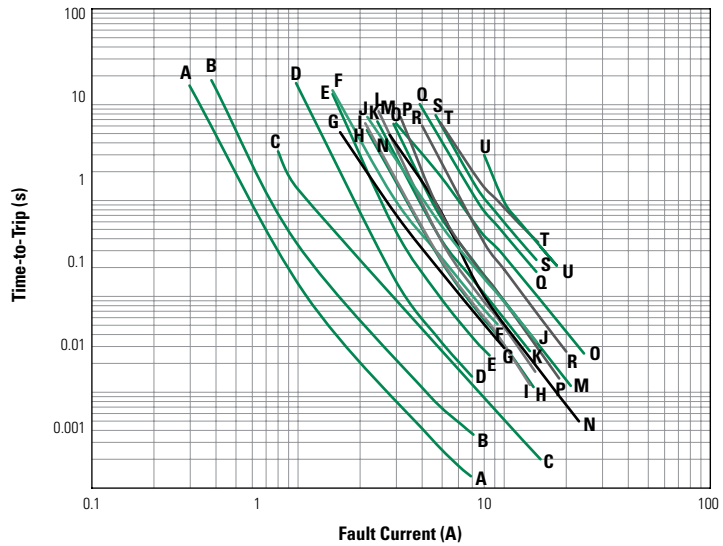

Note: The average time current curves and Temperature Rerating curve performance is affected by a number of variables, and these curves provided as guidance only. Customer must verify the performance in their application.

Temperature Rerating Curve

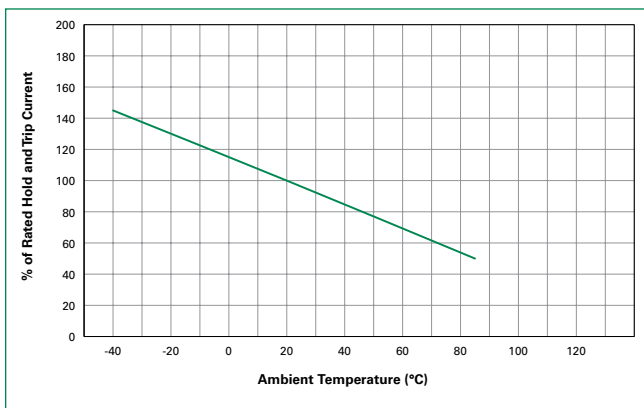

Physical Specifications

Terminal Pad Material	100% Matte Tin with Nickel Underplate
Soldering Characteristics	ANSI/J-STD-002 Category 3
Solder Heat Withstand	per IEC 60068-2-20, Test Tb, Method 1a
Flammability Resistance	per IEC 60695-11-5 Needle Flame Test for 20 seconds

miniSMDC Series

PolySwitch® Resettable PPTCs

Environmental Specifications

Test	Test Method	Conditions	Resistance Change
Storage Life	PS300, Section 5.3.2	60°C, 1000 hrs 85°C, 1000 hrs	±3% typ ±3% typ
Humidity Aging	PS300, Section 5.3.1	85°C, 85% R.H., 100 hrs	±1.2% typ
Thermal Shock	MIL-STD-202, Method 107G	85°C, -40°C (20 Times)	-33% typ
Vibration	MIL-STD-883C	per MIL-STD-883C	No Change
Solvent Resistance	PS300, Section 5.2.2	Freon	No Change
		Trichloroethane	No Change
		Hydrocarbons	No Change

Moisture Resistance Level	Level 2a, J-STD-020
Storage Conditions	40°C max, 70% RH max; devices should remain in original sealed bags prior to use. Devices may not meet specified values if these storage conditions are exceeded.

Dimension

Part Number	Dimensions in Millimeters (Inches)										Figure
	A		B		C		D		E		
	Min	Max	Min	Max	Min	Max	Min	Max	Min	Max	
miniSMDC Series — Size 4532mm/1812mils											
miniSMDC010F	4.37 (0.172)	4.73 (0.186)	0.635	0.89	3.07	3.41 (0.134)	0.25 (0.010)	0.95 (0.040)	0.20 (0.008)	—	1
miniSMDC014F			(0.025)	(0.035)	(0.121)						
miniSMDC020F			0.38	0.62	3.07						
miniSMDC030F			(0.015)	(0.025)	(0.121)						
miniSMDC050F			0.38	0.62	3.07						
miniSMDC075F			(0.015)	(0.025)	(0.121)						
miniSMDC075F/24			0.81	1.46	3.07						
miniSMDC075F/33			(0.032)	(0.057)	(0.121)						
miniSMDC100F			0.94	1.46	3.07						
miniSMDC110F			(0.037)	(0.057)	(0.121)						
miniSMDC110F/16			0.62	0.62	3.07						
miniSMDC110F/24			(0.025)	(0.121)							
miniSMDC125F			0.28	0.48	3.07						
miniSMDC125F/16			(0.011)	(0.019)	(0.121)						

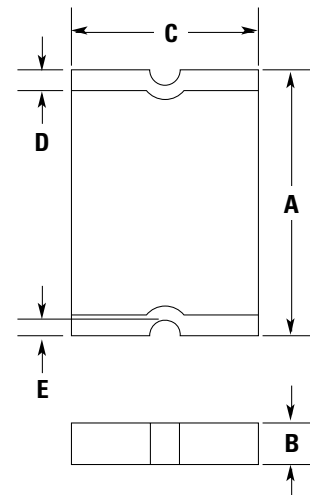

miniSMDC Series

PolySwitch® Resettable PPTCs

Dimension

Part Number	Dimensions in Millimeters (Inches)										Figure	
	A		B		C		D		E			
	Min	Max	Min	Max	Min	Max	Min	Max	Min	Max		
miniSMDC Series — Size 4532mm/1812mils											1	
miniSMDC150F	4.37 (0.172)	4.73 (0.186)	0.28 (0.011)	0.48 (0.019)	3.07 (0.121)	3.41 (0.134)	0.25 (0.010)	0.95 (0.040)	0.20 (0.008)	—		
miniSMDC150F/12												
miniSMDC150F/16		4.83 (0.190)	1.00 (0.040)	1.94 (0.077)								
miniSMDC150F/24												
miniSMDC160F				0.28 (0.011)								0.48 (0.019)
miniSMDC200F		4.73 (0.186)	0.51 (0.020)	1.22 (0.048)								
miniSMDC200F/16												
miniSMDC260F				0.48 (0.019)								0.78 (0.031)
miniSMDC260F/12												
miniSMDC260F/13.2		4.83 (0.190)	1.02 (0.042)	1.52 (0.060)								
miniSMDC260F/16												
miniSMDC300F		4.73 (0.186)	0.45 (0.018)	0.76 (0.030)								

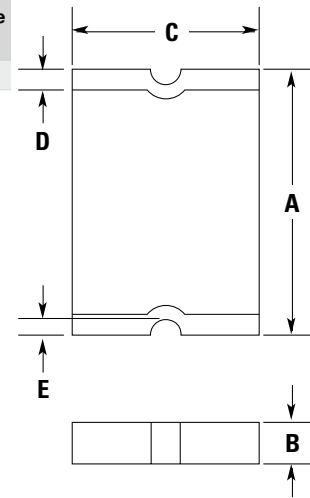

Recommended Pad Layout

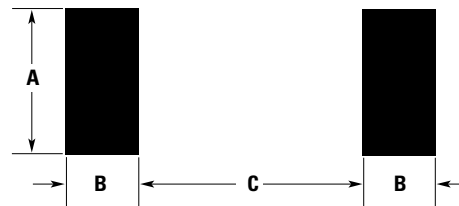

Packaging and Marking Information

Part Number	Tape & Reel Quantity	Standard Package	Part Marking	Recommended Pad Layout Figures [mm (in)]			Agency Recognition
				Dimension A (Nom)	Dimension B (Nom)	Dimension C (Nom)	
miniSMDC Series — Size 4532mm/1812mils							
miniSMDC010F	2,000	10,000	10	3.15 (0.124)	1.68 (0.066)	3.10 (0.122)	UL, CSA, TÜV
miniSMDC014F	2,000	10,000	14	3.15 (0.124)	1.68 (0.066)	3.10 (0.122)	UL, CSA, TÜV
miniSMDC020F	2,000	10,000	2	3.15 (0.124)	1.68 (0.066)	3.10 (0.122)	UL, CSA, TÜV
miniSMDC030F	2,000	10,000	3	3.15 (0.124)	1.68 (0.066)	3.10 (0.122)	UL, CSA, TÜV
miniSMDC050F	2,000	10,000	5	3.15 (0.124)	1.68 (0.066)	3.10 (0.122)	UL, CSA, TÜV
miniSMDC075F	2,000	10,000	7	3.15 (0.124)	1.68 (0.066)	3.10 (0.122)	UL, CSA, TÜV
miniSMDC075F/24	1,500	7,500	075F 24V	3.15 (0.124)	1.68 (0.066)	3.10 (0.122)	UL, CSA, TÜV
miniSMDC075F/33	1,500	7,500	075F 33V	3.15 (0.124)	1.68 (0.066)	3.10 (0.122)	UL, CSA, TÜV
miniSMDC100F	2,000	10,000	1	3.15 (0.124)	1.68 (0.066)	3.10 (0.122)	UL, CSA, TÜV
miniSMDC110F	2,000	10,000	1	3.15 (0.124)	1.68 (0.066)	3.10 (0.122)	UL, CSA, TÜV
miniSMDC110F/16	2,000	10,000	110F 16V	3.15 (0.124)	1.68 (0.066)	3.10 (0.122)	UL, CSA, TÜV
miniSMDC110F/24	1,500	7,500	110F 24V	3.15 (0.124)	1.68 (0.066)	3.10 (0.122)	UL, CSA, TÜV
miniSMDC125F	2,000	10,000	12	3.15 (0.124)	1.68 (0.066)	3.10 (0.122)	UL, CSA, TÜV
miniSMDC125F/16	2,000	10,000	125F 16V	3.15 (0.124)	1.68 (0.066)	3.10 (0.122)	UL, CSA, TÜV
miniSMDC150F	2,000	10,000	15	3.15 (0.124)	1.68 (0.066)	3.10 (0.122)	UL, CSA, TÜV
miniSMDC150F/12	2,000	10,000	150F 12V	3.15 (0.124)	1.68 (0.066)	3.10 (0.122)	UL, CSA, TÜV
miniSMDC150F/16	2,000	10,000	150 16V	3.15 (0.124)	1.68 (0.066)	3.10 (0.122)	UL, CSA, TÜV
miniSMDC150F/24	1,000	5,000	150F 24V	3.15 (0.124)	1.68 (0.066)	3.10 (0.122)	UL, CSA, TÜV
miniSMDC160F	2,000	10,000	16	3.15 (0.124)	1.68 (0.066)	3.10 (0.122)	UL, CSA, TÜV
miniSMDC200F	2,000	10,000	20	3.15 (0.124)	1.68 (0.066)	3.10 (0.122)	UL, CSA, TÜV
miniSMDC200F/16	2,000	10,000	200F 16V	3.15 (0.124)	1.68 (0.066)	3.10 (0.122)	UL, TÜV
miniSMDC260F	2,000	10,000	260F	3.15 (0.124)	1.68 (0.066)	3.10 (0.122)	UL, CSA, TÜV
miniSMDC260F/12	1,500	7,500	260F 12V	3.15 (0.124)	1.68 (0.066)	3.10 (0.122)	UL, CSA, TÜV
miniSMDC260F/13.2	1,500	7,500	260F 13V	3.15 (0.124)	1.68 (0.066)	3.10 (0.122)	UL, CSA, TÜV
miniSMDC260F/16	1,500	7,500	260F 16V	3.15 (0.124)	1.68 (0.066)	3.10 (0.122)	UL, CSA, TÜV
miniSMDC300F	2,000	10,000	30	3.15 (0.124)	1.68 (0.066)	3.10 (0.122)	UL, CSA, TÜV

miniSMDC Series

PolySwitch® Resettable PPTCs

Solder Reflow Recommendations

Profile Feature	Pb-Free Assembly
Average ramp up rate (Ts _{MAX} to Tp)	3°C/s max
Preheat	-
• Temperature min (Ts _{MIN})	150°C
• Temperature max (Ts _{MAX})	200°C
• Time (ts _{MIN} to ts _{MAX})	60-120 s
Time maintained above:	-
• Temperature (T _L)	217°C
• Time (t _L)	60-150 s
Peak/Classification temperature (Tp)	260°C
Time within 5°C of actual peak temperature	-
Time (tp)	30 s max
Ramp down rate	3°C/s max
Time 25°C to peak temperature	8 min max

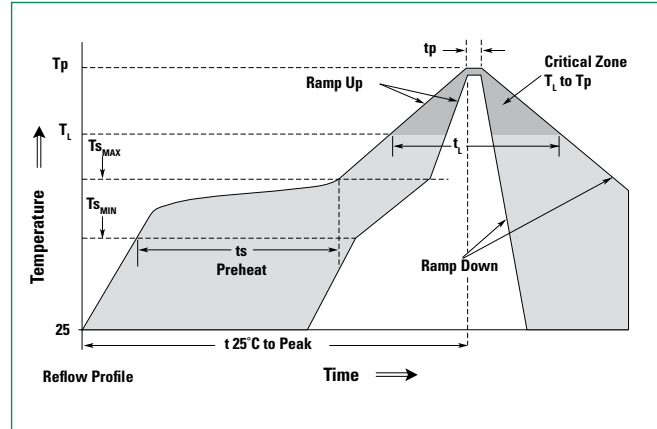

Note: All temperatures refer to topside of the package, measured on the package body surface.

Solder Reflow

- Recommended reflow method: IR, hot air, nitrogen.
- Recommended maximum paste thickness: 0.25mm (0.010in)
- Devices can be cleaned using standard methods and aqueous solvents.
- Experience has shown the optimum conditions for forming acceptable solder fillets occur when a reasonable amount of solder paste is placed underneath each device's termination. As such, we request that customers comply with our recommended solder pad layouts.
- Customer should validate that the solder paste amount and reflow recommendations meet its application.
- We request that customer board layouts refrain from placing raised features (e.g. vias, nomenclature, traces, etc.) underneath PolySwitch devices. It is possible that raised features could negatively impact solderability performance of our devices.

Rework

- Standard industry practices. (Please also avoid direct contact to the device.)

Part Ordering Number System

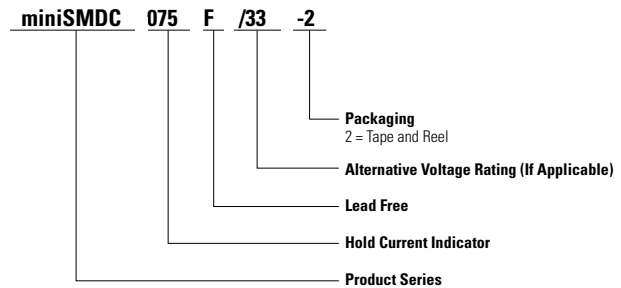

Tape and Reel Specifications

Description	miniSMDC EIA 481-1 (mm)					
	miniSMDC010F miniSMDC014F miniSMDC020F miniSMDC030F miniSMDC050F	miniSMDC075F miniSMDC100F miniSMDC110F miniSMDC110F/16	miniSMDC125F miniSMDC125F/16 miniSMDC150F miniSMDC150F/12 miniSMDC150F/16	miniSMDC160F miniSMDC200F miniSMDC200F/16 miniSMDC260F miniSMDC300F	miniSMDC075F/24 miniSMDC075F/33 miniSMDC110F/24 miniSMDC260F/12 miniSMDC260F/13.2 miniSMDC260F/16	miniSMDC150F/24
W		12.0 ± 0.30			12.0 ± 0.30	12.0 ± 0.30
P ₀		4.0 ± 0.10			4.0 ± 0.10	4.0 ± 0.10
P ₁		8.0 ± 0.10			8.0 ± 0.10	8.0 ± 0.10
P ₂		2.0 ± 0.05			2.0 ± 0.05	2.0 ± 0.05
A ₀		3.5 ± 0.1			3.7 ± 0.1	3.7 ± 0.1
B ₀		4.95 ± 0.1			4.9 ± 0.1	4.9 ± 0.1
B _{1 max}		6.15			6.15	6.15
D ₀		1.55 ± 0.05			1.55 ± 0.05	1.55 ± 0.05
F		5.50 ± 0.10			5.50 ± 0.10	5.50 ± 0.10
E ₁		1.75 ± 0.10			1.75 ± 0.10	1.75 ± 0.10
E _{2 min}		10.25			10.25	10.25
T max		0.35			0.35	0.35
T _{1 max}		0.1			0.1	0.1
K ₀		0.9 ± 0.1			1.4 ± 0.1	1.78 ± 0.1
A max		185			185	185
N min		50			50	50
W ₁		12.4 + 2.0/-0.0			12.4 + 2.0/-0.0	12.4 + 2.0/-0.0
W _{2 max}		18.4			18.4	18.4

miniSMDC Series

PolySwitch® Resettable PPTCs

Tape and Reel Diagrams

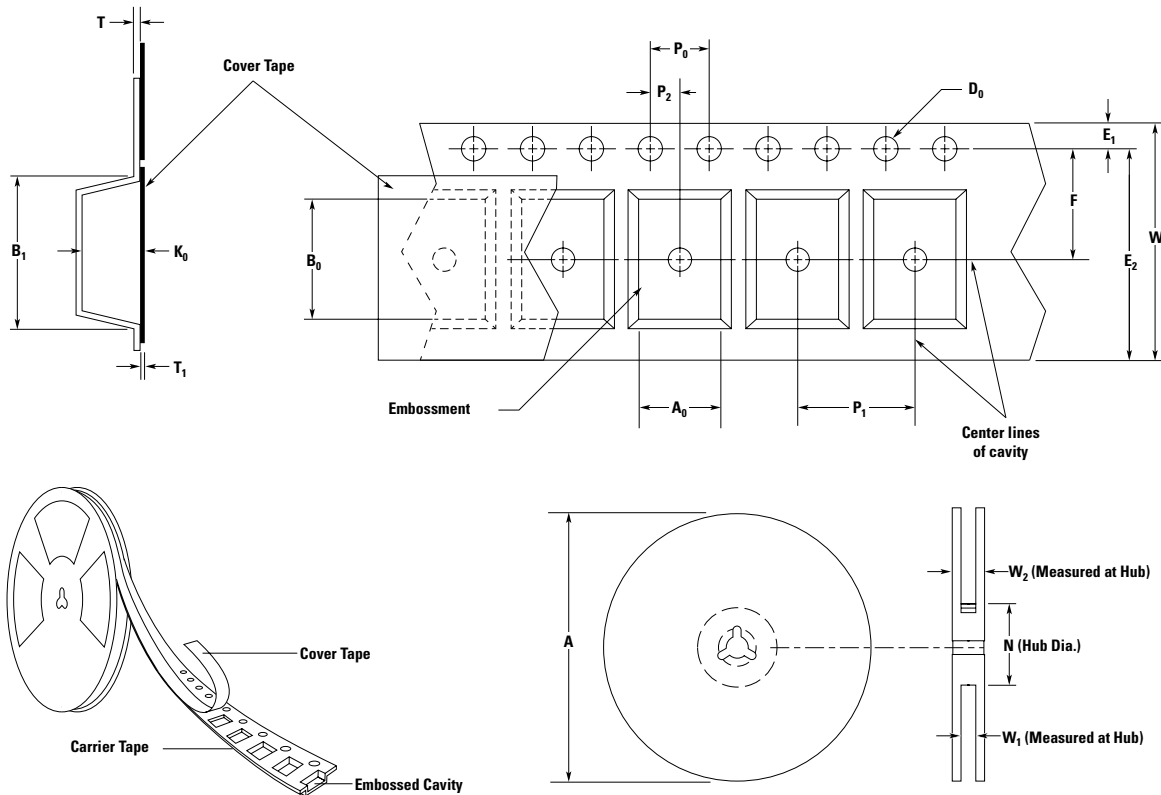

Warning

- Users should independently evaluate the suitability of and test each product selected for their own application.
- Operation beyond the maximum ratings or improper use may result in device damage and possible electrical arcing and flame.
- These devices are intended for protection against damage caused by occasional overcurrent or overtemperature fault conditions and should not be used when repeated fault conditions or prolonged trip events are anticipated.
- Contamination of the PPTC material with certain silicone-based oils or some aggressive solvents can adversely impact the performance of the devices.
- Device performance can be impacted negatively if devices are handled in a manner inconsistent with recommended electronic, thermal, and mechanical procedures for electronic components.
- PPTC devices are not recommended for installation in applications where the device is constrained such that its PTC properties are inhibited, for example in rigid potting materials or in rigid housings, which lack adequate clearance to accommodate device expansion.
- Operation in circuits with a large inductance can generate a circuit voltage (Ldi/dt) above the rated voltage of the device.

Disclaimer Notice - Information furnished is believed to be accurate and reliable. However, users should independently evaluate the suitability of and test each product selected for their own applications. Littelfuse products are not designed for, and may not be used in, all applications. Read complete Disclaimer Notice at www.littelfuse.com/disclaimer-electronics.