



DEUTSCH
INDUSTRIAL PRODUCTS DIVISION



DRC Series Technical Manual



INDEX

DRC SERIES -
A Technical Discussion

Technical Data
Part Numbering System
Material Specifications
General Specifications

Contacts and Application

Drawings

Plugs
Receptacles
Insert Arrangements

Installation/Removal
Accessories

Glossary of Terms

Page

1, 2

3

4

5

6

6



Contact Retention System

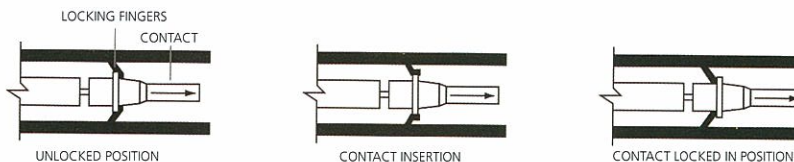

CONTACT INSERTION PROCEDURE



CONTACT REMOVAL PROCEDURE

Connector Sealing Elements

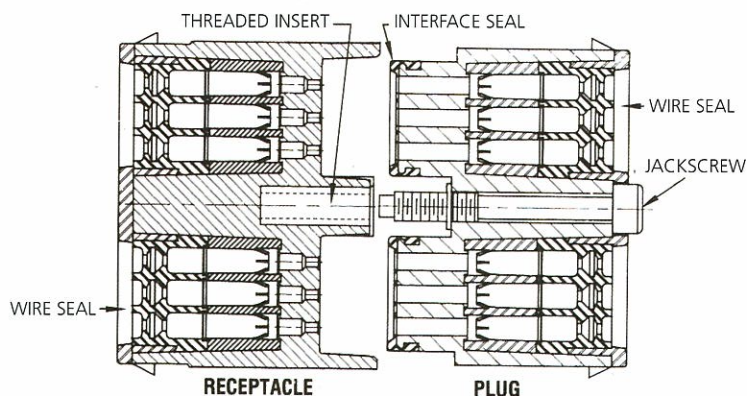

Mating Criteria

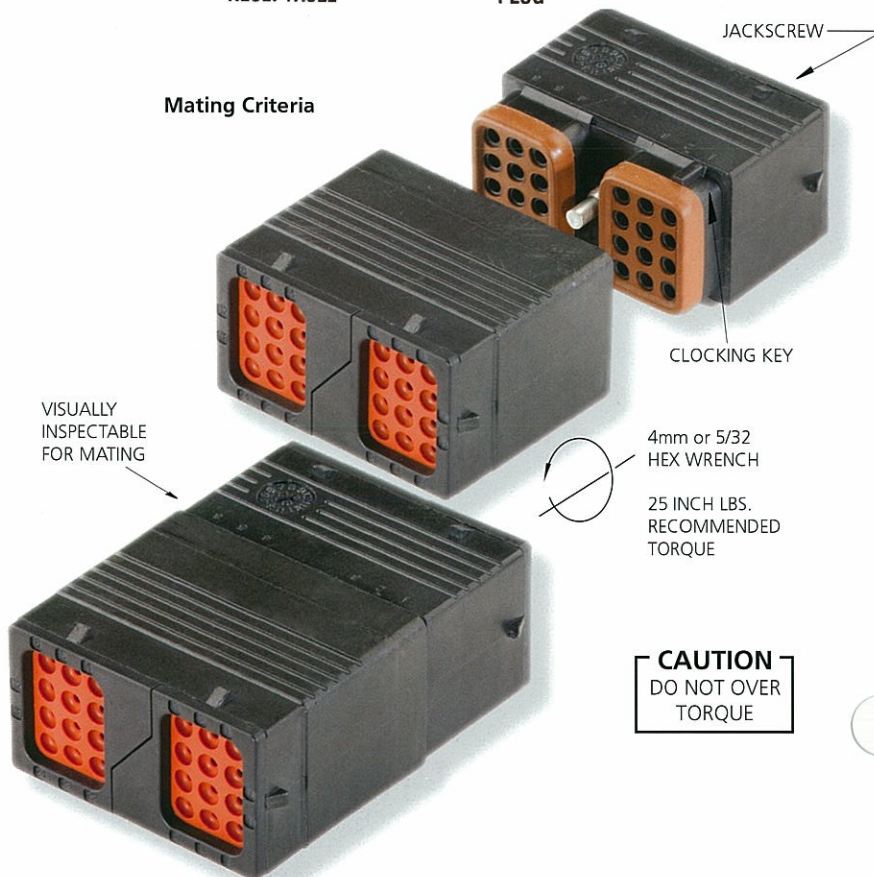

CAUTION
DO NOT OVER
TORQUE



ELECTRICAL INTERCONNECTIONS FOR HEAVY DUTY EQUIPMENT

The heavy duty connector industry is into the most dynamic and challenging time in its history. Computerized sensors, monitoring devices and expanding electronics in trucks, buses, off-road equipment and farm machinery are changing design objectives. These objectives must not only address the electrical requirements, but give heavy consideration to the future maintenance and service of these new high technology systems.

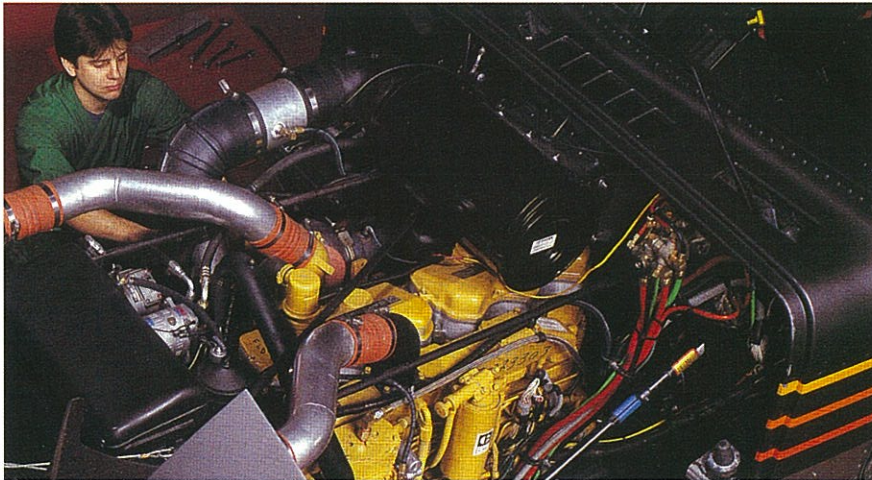

The Challenge

Increasingly intricate electronic systems will continue to drive the demand for heavy duty interconnections well into the next century. Most notable are: engine, controls, transmission controls, electronic panels, ABS, traction controls, navigation and electrical load management. Designers of these new systems must address difficult criteria for connector selection, these include:

- Higher Density - Greater Number of Terminals
- Data Transmission Added to Power Distribution
- Non-Cab Mounted Electronics
- Significance of Total Installed Cost

Introducing the Deutsch DRC Series

Taking advantage of the many years Deutsch continues to be a major supplier of electrical interconnections for the heavy duty equipment industry. Working with design manufacturing and test

personnel at the leading O.E.M.s in the truck, bus and off-highway industry, we have defined the Deutsch rectangular connector series.

Deutsch DRC Series Design

The DRC Series is designed with a higher number of terminal counts. Insert arrangements of 24, 40, 50, 60, 70, 76 and 80 contacts are tooled and available. The use of size 12,16 and 20 crimp type contacts common to the other Deutsch product lines simplifies the design effort required to accomplish electrical and mechanical criteria.

By utilizing a rectangular shape, the DRC is best suited to be compatible

with externally or internally mounted electronic modules. P.C.B. applications are addressed with the DRC Series receptacles being supplied with contact terminations designed for flex-tape or direct board mountings.

The Deutsch DRC Series is completely environmentally sealed, using silicone seals and wire grommets that withstand engine and transmission temperatures. The rugged thermoplastic housings are designed to meet field abuse for the life of the equipment.

The DRC contact systems decrease installation costs and increase reliability.

- Crimp type, solid or stamped and formed copper alloy contacts eliminate the need to solder.
- Wire seals are designed in the connector housing - no need to attach the seals to the wire.
- The DRC dielectric contact retention

system is an integral part of the connector insert, thus allowing quick and easy assembly, while providing a positive lock for reliability.

- As in all Deutsch products, a common contact design is specified. This commonality reduces inventory costs and eliminates the chance of error in the harness system, as the termination process is common, allowing assembly operators repeat performance regardless of wire size. This ensures the repeatability of crimping, inserting and inspection.

DRC Features/Benefits

Rugged thermoplastic shells. Designed for **heavy duty service**.

Environmentally sealed against moisture and contaminants. Silicone wire grommets are an integral part of the connector, reducing total installed costs.

-55°C to +125°C continuous operation at rated current for engine service.

Available in **high density pin counts** of 24, 40, 50, 60, 70, 76 and 80, meeting most electronic design demands.

Crimp-type, nickel or gold plated solid or stamped and formed copper alloy contacts increase **durability** and reduce **installation costs** by eliminating soldering after crimping.

Positive locking contact retention system by use of dielectric "fingers" designed in the connector inserts, thus, eliminating the need for a second lock.

Quick, fool-proof assembly, decreasing time on the assembly line and increasing profits. The ease of contact insertion and removal reduces field-service down time.

Deutsch's common contact system **slashes inventory costs**, and **reduces the chance of errors** caused by hundreds of different types of terminations within one harness assembly.



PART NUMBERING SYSTEM

DRC 14 - 40 P A X - XXXX

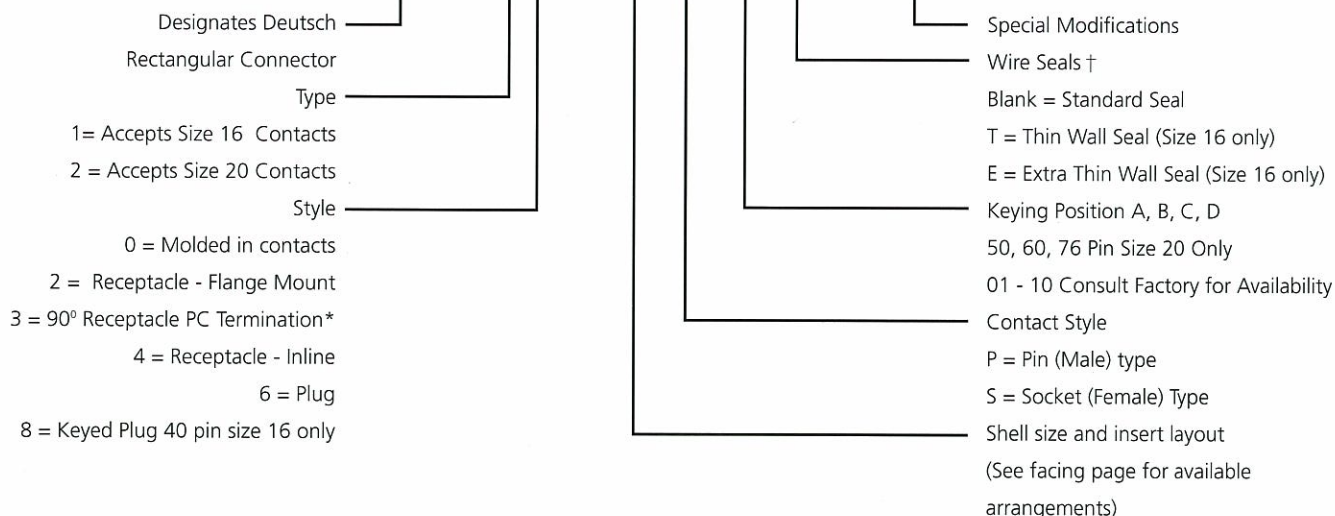

MATERIAL SPECIFICATIONS

Plug

Shell: Thermoplastic
 Insert: Retainer-Thermoplastic Grommet-Silicone Rubber
 Jackscrew: Stainless Steel

Receptacle

Shell: Thermoplastic
 Insert: Retainer-Thermoplastic Grommet-Silicone Rubber
 Threaded Insert: Stainless Steel

Contacts

Pin: Copper Alloy
 Socket: Copper Alloy
 Finish: Nickel (optional - gold) Plated

Sealing Plugs

Thermoplastic: Size 20
 Size 16
 Size 12

GENERAL SPECIFICATIONS

Dielectric Withstanding Voltage

Current leakage less than 2 milliamps at 1500 VAC

Insulation Resistance:

1000 megohms minimum at 25° C.

Current Rating (Maximum):

Size 20: 7.5 amps
 Size 16: 13 amps
 Size 12: 25 amps

Submersion:

Properly wired and mated connection will withstand immersion under three feet of water without loss of electronic qualities or leakage.

Fluid Resistance:

Connectors show no damage when exposed to most fluids used in industrial applications.

Vibration:

No unlocking or unmating and exhibits no mechanical or physical damage after sinusoidal vibration levels of 20 G's at 10 to 2000 Hz in each of the three mutually perpendicular planes.
 No electrical discontinuities longer than 1 millisecond.

Temperature:

Operative at temperatures from -55°C to +125°C.
 Continuous at rated current.

Contact Retention:

Contacts withstand a minimum load of:
 20 lbs (89N) for size 20
 25 lbs (111N) for size 16
 30 lbs (133N) for size 12

Thermal Cycle:

No cracking, chipping or leaking after 20 test cycles from -55°C to +125°C.

Durability:

No electrical or mechanical defects after 100 cycles of engagement and disengagement.

WIRE SEALING RANGE

SEAL TYPE	CONTACT SIZE	INCH	MM
STD	20	.040 - .095	1.02 - 2.41
STD	16	.100 - .134	2.54 - 3.40
*REDUCED "T"	16	.088 - .134	2.24 - 3.40
**REDUCED "E"	16	.053 - .120	1.35 - 3.05
STD	12	.134 - .170	2.54 - 4.32

* T Seal: Brown Caps
 ** E-Seal: Blue Strip on Cap

CONTACT RESISTANCE

CONTACT SIZE	WIRE GAUGE AWG(mm ²)	Test Current (Amps)	Resistance (mV) Solids	Resistance (mV) Stamped & Formed
20	20 (.50)	7.5	60	100
	18 (.80)	7.5	60	100
	16 (1.0)	7.5	60	100
16	20 (.50)	7.5	60	100
	18 (.80)	10	60	100
	16 (1.0)	13	60	100
12	14 (2.0)	13	60	100
	14 (2.0)	18	60	100
	12 (3.0)	25	60	100



CONTACTS AND APPLICATION DATA

SIZE	SOLID CONTACT PART NUMBERS		WIRE SIZE AWG (mm ²)	RECOMMENDED STRIP LENGTH INCHES (mm)	MIN CONTACT RETENTION LBS (N)	REF CRIMP TENSILE LBS (N)	MAX RATED AMPS AT 125°C CONTINUOUS
	PIN	SOCKET					
20	0460-202-20**	0462-201-20**	20 (0.50)	.156-.218 (3.96 - 5.54)	20 (89)	20 (89)	7.5
16	0460-215-16**	0462-209-16**	14 (2.0)	.250 - .312 (6.35 - 7.92)	25 (111)	70 (311)	13
16	0460-202-16**	0462-201-16**	16-20 (1.0 - 0.50)	.250 - .312 (6.35 - 7.92)	25 (111)	35-20 (156-89)	13
12	0460-204-12**	0462-203-12**	12-14 (3.0 - 2.0)	.222 - .284 (5.64 - 7.21)	30 (134)	75-70 (334 - 311)	25

Solid Contacts

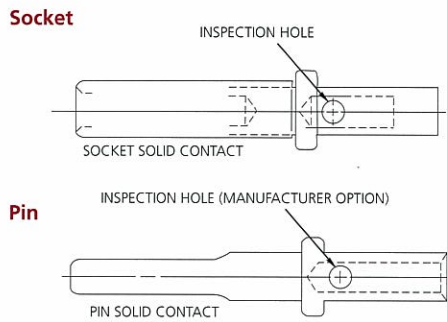

Stamped and Formed Contacts

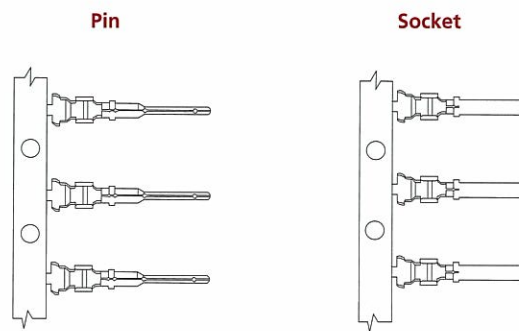

SIZE	STAMPED & FORMED CONTACT PART NUMBERS		CARRIER STRIP IDENTIFICATION	WIRE SIZE AWG (mm ²)	WIRE INSULATION O.D. RANGE	RECOMMENDED STRIP LENGTH INCHES (mm)	MIN CONT. RETENTION LBS (N)	REF CRIMP TENSILE LBS (N)	MAX RATED AMPS AT 125°C CONTINUOUS
	PIN	SOCKET							
20	1060-20-01**	1062-20-01**	20 - 01	16 - 22 (1.0 - 0.35)	.075 - .125 (1.91 - 3.15)	.150 - .200 (3.81 - 5.08)	20 (89)	20 - 10 (89 - 45)	7.5
20	1060-20-02**	1062-20-02**	20 - 02	16 - 22 (1.0 - 0.35)	.051 - .085 (1.30 - 2.16)	.150 - .200 (3.81 - 5.08)	20 (89)	20 - 10 (89 - 45)	7.5
20	N/A	1062-20-03**	20 - 03	16 - 22 (1.0 - 0.35)	.075 - .125 (1.91 - 3.15)	.150 - .200 (3.81 - 5.08)	20 (89)	20 - 10 (89 - 45)	7.5
16	1060-14-01**	1062-14-01**	14-16	14 - 18 (2.0 - .75)	.095 - .150 (2.41 - 3.81)	.150 - .200 (3.81 - 5.08)	25 (111)	25 (111)	13
16	1060-14-10**	1062-14-10**	14 - 16	14 - 18 (2.0 - .75)	.095 - .150 (2.41 - 3.81)	.150 - .200 (3.81 - 5.08)	25 (111)	25 (111)	13
16	1060-16-01**	1062-16-01**	16 - 18	14 - 18 (2.0 - .75)	.075 - .140 (1.91 - 3.55)	.150 - .200 (3.81 - 5.08)	25 (111)	25 (111)	13
16	1060-16-06**	1062-16-06**	0.5 - 1.0	16 - 20 (1.0 - 0.50)	.055 - .100 (1.40 - 2.54)	.150 - .200 (3.81 - 5.08)	25 (111)	25 - 15 (111 - 67)	13
16	1060-16-07**	1062-16-07**	0.75 - 2.0	14 - 18 (2.0 - .75)	.075 - .115 (1.91 - 2.92)	.150 - .200 (3.81 - 5.08)	25 (111)	25 (111)	13
16	1060-16-09**	1062-16-09**	16 - 18	14 - 18 (2.0 - .75)	.075 - .140 (1.91 - 3.55)	.150 - .200 (3.81 - 5.08)	25 (111)	25 (111)	13
16	1060-16-12**	1062-16-12**	1.0 - 2.5	12 - 16 (2.5 - 1.0)	.075 - .140 (1.91 - 3.55)	.175 - .225 (4.45 - 5.72)	25 (111)	25 (111)	13
16	N/A	1062-16-14**	14 - 16	12 - 16 (2.5 - 1.0)	.075 - .140 (1.91 - 3.55)	.175 - .225 (4.45 - 5.72)	25 (111)	25 (111)	13
12	1060-12-01**	1062-12-01**	12 - 14	12 - 14 (4.0 - 2.0)	.113 - .176 (2.87 - 4.47)	.225 - .275 (5.72 - 6.99)	30 (134)	70 (311)	25
12	1060-12-02**	1062-12-02**	10 - 12	10 - 12 (6.0 - 4.0)	.140 - .204 (3.56 - 5.18)	.225 - .275 (5.72 - 6.99)	30 (134)	70 (311)	25

NOTE: The above tables are for reference only. Consult factory for more information.



DRC INSERT ARRANGEMENTS

# CAVITIES	CAVITY SIZE(S)	CONTACT SIZE	CONFIGURATION
24	20 ga	20	Inline, flange mount, PCB
40	16 ga	16	Inline, flange mount, PCB
50	20 ga	20	PCB
60	20 ga	20	PCB
70	16 ga	16	Inline, flange mount, PCB
76	20ga(68), 12ga(8)	20(68), 12(8)	PCB
80	20 ga	20	PCB

INLINE RECEPTACLE

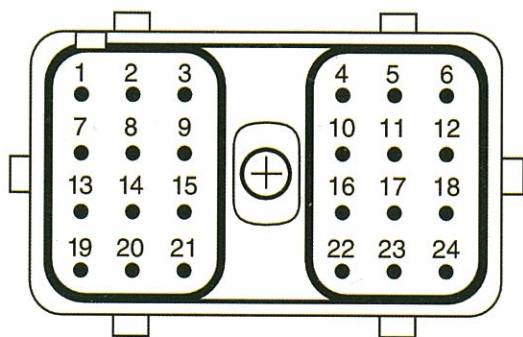

PCB RECEPTACLE

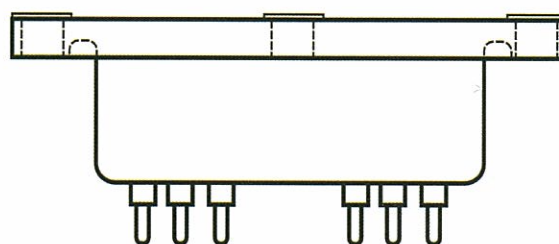

FLANGE MOUNT RECEPTACLE

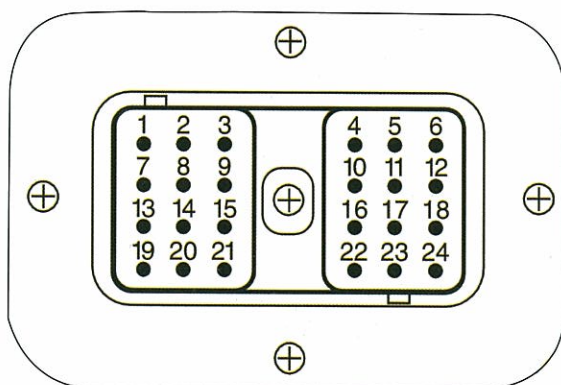

STANDARD PLUG

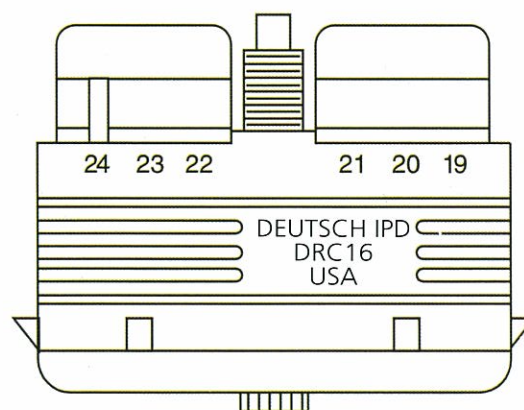

NOTE:

Several modifications to the above standards are available. Consult your local Deutsch representative or the factory for specific requirements.



INSTALLATION / REMOVAL ACCESSORIES

Removal Tools

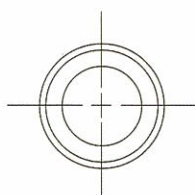
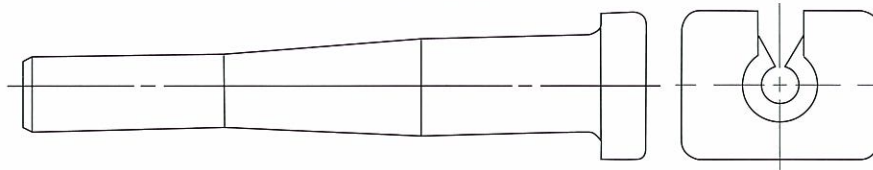

Sealing Plug

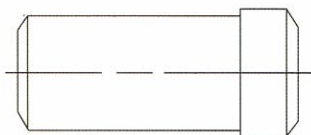

PART NUMBER	CONT. SIZE
114017	12&16
0413-204-2005	20

SIZE	PART NUMBER	SEAL TYPE
20	0411-240-2005	N SEAL
16	0411-204-1605	N
16	0411-291-1405	N SIZE 16/14
16	0411-310-1605	T SEAL
16	0411-336-1605	E SEAL
12	0411-377-1205	E

GLOSSARY OF TERMS

Backshell:	A plastic protective covering that either snaps-on or threads to the rear of a connector providing aesthetics, protection and strain relief.
Blocked Cavities:	A modification to the rear connector grommet that includes all or selected cavities permanently sealed for unused cavities.
Boot:	A protective covering designed to fit on the rear of the connector providing aesthetics, protection and strain relief.
Bulkhead:	A term used to define a mounting style of connectors. Designed to be inserted into a panel cutout.
Cavity:	A defined hole in the connector grommet and housing into which the contact must fit.
Contact:	The conductive element in a termination assembly which is crimped onto a wire with a corresponding contact for the purpose of transferring electricity.
Contact Rating:	The maximum specified amperage to be passed through a contact.
Dust Cover:	A cap or cover to protect the connector interface when either the plug or receptacle are unmated.
E-seal:	Smaller grommet seal to accommodate very thin wire insulation. Contact sales for insulation ranges.
Flange:	A projection extending on the connector used for strength or having holes that provide for mounting to a panel.
Flange Seal:	Environmental seal between the connector flange and panel.
Front Seal:	Environmental seal between the entire mating interface of plug and receptacle seal. The seal itself is usually found on the plug. Also referred to as interface seal.
Grommet:	An integral rubber seal used on the cable side (rear) of a connector to provide an environmental seal.
Inline:	A term used for connectors that do not have the capability for use for mounting or PCB applications.
Interface:	The two surfaces of a mating pair of connectors that face each other when assembled.
Internal Seal:	An internal environmental seal which provides sealing when a plug and receptacle are fully mated.
Key:	A projection which engages with a keyway to guide a connector during mating. Prevents mis-mating.
N-Seal:	Normal seal. Refers to grommet cavity diameter. Contact sales for insulation ranges.
PCB Mount:	Term used for receptacle connector designed specifically for printed circuit board applications.
Pin:	Male contact. Pins are usually housed by the receptacle.
Plug:	One half of a mated pair of connectors which mates with the receptacle. This half always has the mating locking mechanism. Plugs usually house the socket contact.
Receptacle:	One half of a mated pair of connectors which mates with the plug. Receptacles usually house the pin contact.
Removal Tool:	A tool designed to remove contacts from the connector. Size and color may vary to match wire gauge.
Sealing Plug:	A solid plastic rod designed to be inserted into an unused grommet cavity to maintain an environmental seal.
Socket:	Female contact. Sockets are usually housed by the plug.
Solid Contact:	Contacts manufactured using a cold heading process. Designed for heavy duty applications. Sold in bulk. Solid contacts have a closed crimp barrel.
Stamped and Formed Contact:	Contacts manufactured using a precision stamping machine. Provides a low cost and reliable termination. Sold on reels. Stamped and Formed contacts have an open crimp area.
T-Seal:	Thin wall seal. Refers to grommet cavity diameter. Contact sales for insulation ranges.
Socket:	Female contact. Sockets are usually housed by the plug.
Wire Router:	Protective piece attached to a connector rear. Used for wire bundle strain relief.



DEUTSCH
INDUSTRIAL PRODUCTS DIVISION

3850 Industrial Avenue, Hemet, California 92545 Tel.: (951) 765-2250 - Fax: (951) 765-2255
E-mail : insidesales@deutschpd.net - Web : www.deutschpd.net - Edition 2007

A STEP AHEAD