

## 0.4 mm Contact Pitch Board-to-Board /Board-to-FPC Connectors

### DF40 Series

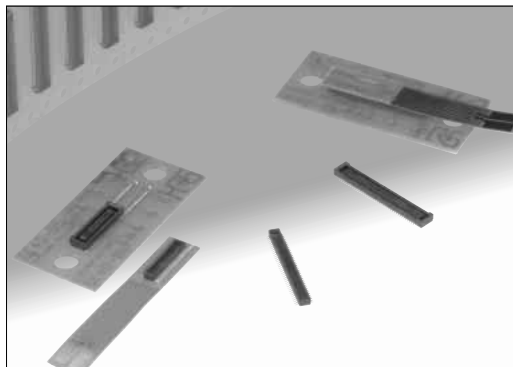

#### Decrease in the board-occupied area

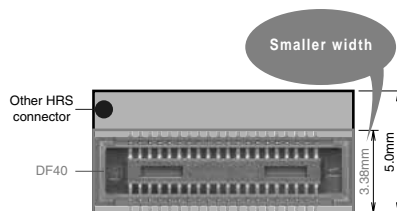

#### ■ Features

- 1. Higher density of the board-mounted components**  
Extremely small board mounting pattern and low above-the-board profile makes the connectors ideally suited for small device applications.

- 2. Stacking height variation : 1.5mm to 4.0mm**

- 3. High contact reliability**

Despite connectors small size and low profile the contacts provide strong contact forces and long contact wipe (0.45 mm), guaranteeing reliable electrical and mechanical performance.

- 4. Large self-alignment distance**

The connectors will self-align within 0.33 mm.

- 5. Confirmation of the fully mated condition**

Positive "click" sensation confirms correct insertion and connection of all contacts.

- 6. Built-in shock absorbing feature**

The protrusions and indents in the insulator bodies protect the connectors from failures when exposed to sudden impact.

- 7. Solder wicking prevention**

Nickel-plated barriers provide protection against solder wicking into the contact areas.

- 8. Contact area protection**

External walls protect the exposed contact areas from intrusion of flux or foreign particles.

- 9. RoHS compliant**

All components and materials comply with the requirements of the EU Directive 2002/95/EC.

#### ■ Applications

Cellular phones, Digital Video Cameras, Digital Still Cameras, portable devices and other small applications requiring reliable board-to-board or FPC-to-board connections.

#### High contact reliability – Effective connection wipe of 0.45 mm

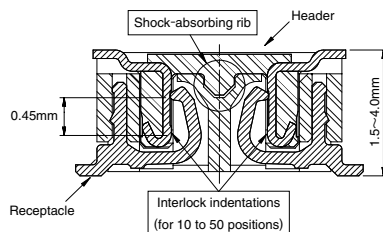

#### Stacking Height variation

Stacking Height	Number of Contacts					
	1.5mm	2.0mm	2.5mm	3.0mm	3.5mm	4.0mm
10	○	—	—	—	—	—
20	○	○	○	—	—	—
24	○	—	—	—	—	—
30	○	○	△	○	○	—
40	○	○	△	—	—	△
44	—	△	—	○	—	—
50	○	○	○	○	○	△
60	○	○	—	○	○	—
70	○	—	—	—	—	—
80	○	—	—	—	—	—
100	○	—	—	—	—	—

△: Reserved for product expansion

## Product Specifications

Ratings	Current rating	0.3A	Operation temperature range	-35°C to +85°C (Note 1)	Storage temperature range	-10°C to +60°C (Note 2)
	Voltage rating	30V AC, DC	Operation humidity range	RH 20% to 80%	Storage humidity range	RH 40% to 70% (Note 2)

Item	Specification	Conditions
1. Insulation resistance	50 MΩ min.	100V DC
2. Withstanding voltage	No flashover or insulation breakdown.	100V AC / one minute
3. Contact resistance	90 mΩ max.	1mA, 20mV AC, 1 kHz
4. Vibration	No electrical discontinuity of 1 μs or more.	Frequency: 10 to 55 Hz, single amplitude of 0.75mm, 2 hours, 3 axis
5. Humidity	Contact resistance: 90 mΩ max. Insulation resistance: 25 MΩ min.	96 hours at +40±2°C and humidity of 90% to 95%.
6. Temperature cycle	Contact resistance: 90 mΩ max. Insulation resistance: 50 MΩ min.	Temperature: -55→+5°C to 35°C→+85°C→+5°C to +35°C Time: 30→10→30→10 (Minutes) 5 cycles
7. Durability (insertion/withdrawal)	Contact resistance: 90 mΩ max.	30 cycles
8. Resistance to soldering heat	No deformation of components affecting performance.	Reflow: At the recommended temperature profile Manual soldering: 350°C for 3 seconds

Note 1: Includes temperature rise caused by current flow.

Note 2: The term "storage" refers to products stored for long period of time prior to mounting and use. Operating temperature range and humidity range covers non-conducting condition of installed connectors in storage, shipment or during transportation.

## Materials

Product	Part	Material	Finish	Remarks
Receptacles Headers	Insulator	LCP	Color : Black	UL94V-0
	Contacts	Phosphor bronze	Gold plated	—

## Ordering information

### ● Receptacle

**DF40 # (\*\*\*) - \* DS - 0.4 V (\*\*\*)**

①
②
③
④
⑤
⑥
⑦
⑧

① Series Name : DF40	② Configuration C: Without metal fittings HC: Without metal fittings (Stacking height : 2.5mm to 4.0mm)	③ Stacking Height	⑤ Connector Type DS : Double-row receptacle
		④ Number of Contacts	
		⑦ Terminal Type V: SMT vertical mount	⑧ Packaging (51) : Embossed tape packaging

### ● Header

**DF40 # - \* DP - 0.4 V (\*\*\*)**

①
②
③
④
⑤
⑥
⑦

① Series Name : DF40	③ Number of Contacts	⑤ Contact Pitch : 0.4mm
② Configuration C: Without metal fittings	④ Connector Type DP : Double-row pin header	⑥ Terminal Type V: SMT vertical mount
		⑦ Packaging (51) : Embossed tape packaging

## ■ Receptacles (Stacking Height : 1.5mm)

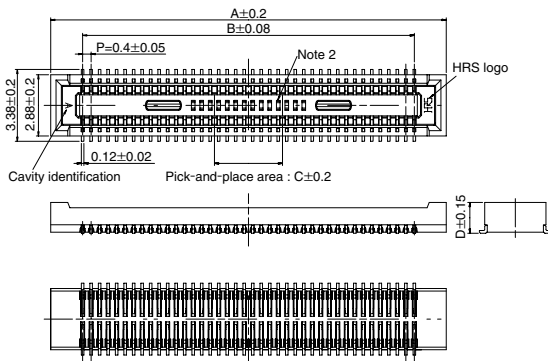
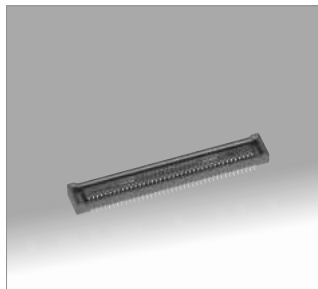

## ◆ Recommended PCB mounting pattern

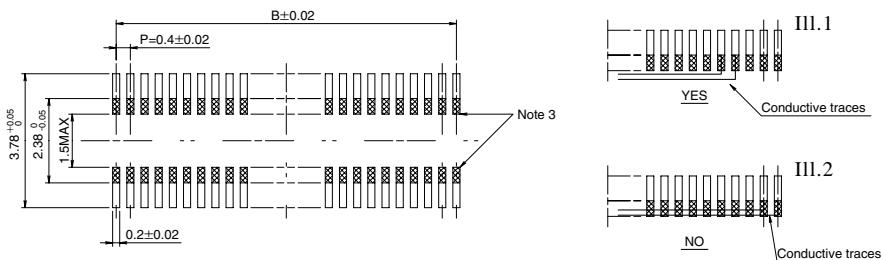

[Specification number]  
 (51): Embossed tape packaging (5,000 pieces per reel)

## ● Stacking Height : 1.5mm

Part Number	CL No.	Number of contacts	A	B	C	D	RoHS
DF40C- 10DS-0.4V(51)	684-4036-2-51	10	4.6	1.6	1.0	1.45	YES
DF40C- 20DS-0.4V(51)	684-4005-9-51	20	6.6	3.6	1.0	1.45	
DF40C- 24DS-0.4V(51)	684-4006-1-51	24	7.4	4.4	1.2	1.45	
DF40C- 30DS-0.4V(51)	684-4007-4-51	30	8.6	5.6	1.5	1.45	
DF40C- 40DS-0.4V(51)	684-4008-7-51	40	10.6	7.6	3.2	1.45	
DF40C- 50DS-0.4V(51)	684-4009-0-51	50	12.6	9.6	3.2	1.45	
DF40C- 60DS-0.4V(51)	684-4004-6-51	60	14.6	11.6	3.2	1.45	
DF40C- 70DS-0.4V(51)	684-4016-5-51	70	16.6	13.6	3.2	1.45	
DF40C- 80DS-0.4V(51)	684-4002-0-51	80	18.6	15.6	3.2	1.45	
DF40C-100DS-0.4V(51)	684-4033-4-51	100	22.6	19.6	3.2	1.45	

Unit: mm

Note 1: Order by number of reels.

Note 2: Connectors with 60 or 100 contacts may have several recessed areas in this location. Pick-and-place operation will NOT be affected.

Note 3: No conductive traces through the areas indicated by .

Refer to III.1 and III.2, for specific restrictions and exception to the above requirement.

Note 4: This connector is NOT polarized.

## ■ Receptacles (Stacking Height : 2.0mm)

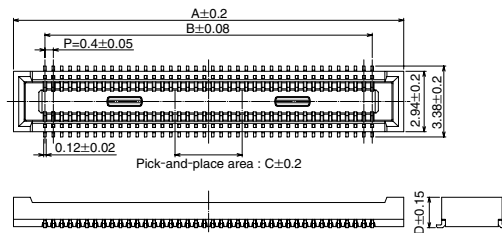

## ◆ Recommended PCB mounting pattern

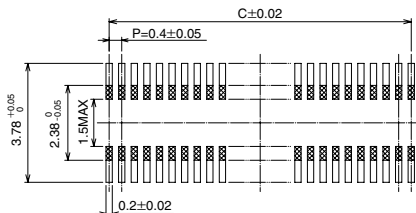

[Specification number]

(51): Embossed tape packaging (4,000 pieces per reel)

### ● Stacking Height : 2.0mm

Unit: mm

Part Number	CL No.	Number of contacts	A	B	C	D	RoHS
DF40C(2.0)- 20DS-0.4V(51)	684-4040-0-51	20	6.6	3.6	1.0	1.95	YES
DF40C(2.0)- 30DS-0.4V(51)	684-4058-5-51	30	8.6	5.6	1.5	1.95	
DF40C(2.0)- 40DS-0.4V(51)	684-4042-5-51	40	10.6	7.6	3.2	1.95	
DF40C(2.0)- 44DS-0.4V(51)	Reserved for product expansion	44	11.4	8.4	3.2	1.95	
DF40C(2.0)- 50DS-0.4V(51)	684-4091-0-51	50	12.6	9.6	3.2	1.95	
DF40C(2.0)- 60DS-0.4V(51)	684-4034-7-51	60	14.6	11.6	3.2	1.95	
DF40C(2.0)- 80DS-0.4V(51)	684-4132-6-51	80	18.6	15.6	3.2	1.95	

Note 1: Order by number of reels.

Note 2: Connectors with 60 or 100 contacts may have several recessed areas in this location. Pick-and-place operation will NOT be affected.

Note 3: No conductive traces through the areas indicated by .

Refer to III.1 and III.2, for specific restrictions and exception to the above requirement.

Note 4: This connector is NOT polarized.

## ■ Receptacles (Stacking Height : 2.5mm to 4.0mm)

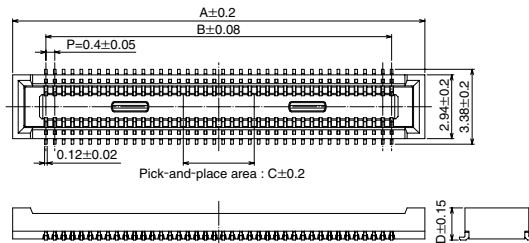
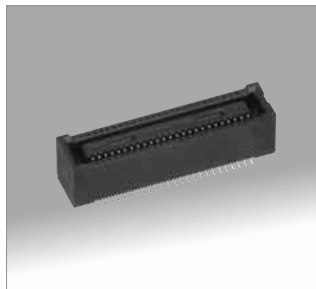

## ◆ Recommended PCB mounting pattern

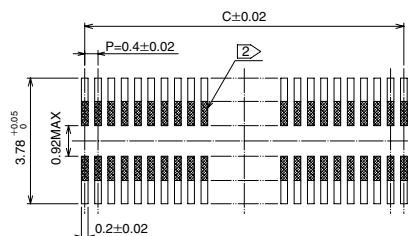

### ● Stacking Height : 2.5mm

[Specification number]  
(51): Embossed tape packaging (3,000 pieces per reel)

Part Number	CL No.	Number of contacts	A	B	C	D	RoHS
DF40HC(2.5)- 20DS-0.4V(51)	684-4126-3-51	20	6.6	3.6	1.0	2.4	
DF40HC(2.5)- 30DS-0.4V(51)	Reserved for product expansion	30	8.6	5.6	1.5	2.4	
DF40HC(2.5)- 40DS-0.4V(51)	Reserved for product expansion	40	10.6	7.6	3.2	2.4	YES
DF40HC(2.5)- 50DS-0.4V(51)	684-4101-2-51	50	12.6	9.6	3.2	2.4	
DF40HC(2.5)- 60DS-0.4V(51)	684-4085-8-51	60	14.6	11.6	3.2	2.4	

Unit: mm

### ● Stacking Height : 3.0mm

[Specification number]  
(51): Embossed tape packaging (3,000 pieces per reel)

Part Number	CL No.	Number of contacts	A	B	C	D	RoHS
DF40HC(3.0)- 30DS-0.4V(51)	684-4098-0-51	30	8.6	5.6	1.5	2.9	
DF40HC(3.0)- 44DS-0.4V(51)	684-4076-7-51	44	11.4	8.4	3.2	2.9	
DF40HC(3.0)- 50DS-0.4V(51)	684-4099-2-51	50	12.6	9.6	3.2	2.9	YES
DF40HC(3.0)- 60DS-0.4V(51)	684-4100-0-51	60	14.6	11.6	3.2	2.9	

Unit: mm

### ● Stacking Height : 3.5mm

[Specification number]  
(51): Embossed tape packaging (2,000 pieces per reel)

Part Number	CL No.	Number of contacts	A	B	C	D	RoHS
DF40HC(3.5)- 30DS-0.4V(51)	684-4136-7-51	30	8.6	5.6	1.5	3.4	
DF40HC(3.5)- 50DS-0.4V(51)	684-4109-4-51	50	12.6	9.6	3.2	3.4	YES
DF40HC(3.5)- 60DS-0.4V(51)	684-4102-5-51	60	14.6	11.6	3.2	3.4	

Unit: mm

### ● Stacking Height : 4.0mm

[Specification number]  
(51): Embossed tape packaging (2,000 pieces per reel)

Part Number	CL No.	Number of contacts	A	B	C	D	RoHS
DF40HC(4.0)- 40DS-0.4V(51)	Reserved for product expansion	40	10.6	7.6	3.2	3.9	
DF40HC(4.0)- 50DS-0.4V(51)	Reserved for product expansion	50	12.6	9.6	3.2	3.9	YES

Unit: mm

Note 1: Order by number of reels.

Note 2: Connectors with 60 or 100 contacts may have several recessed areas in this location. Pick-and-place operation will NOT be affected.

Note 3: No conductive traces through the areas indicated by .

Refer to III.1 and III.2. for specific restrictions and exception to the above requirement.

Note 4: This connector is NOT polarized.

## Header

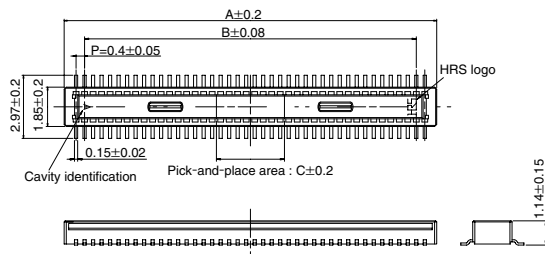
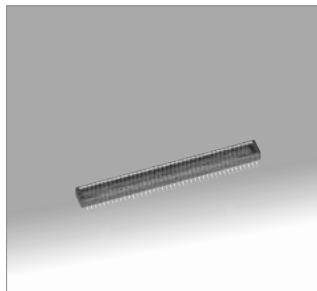

## Recommended PCB mounting pattern

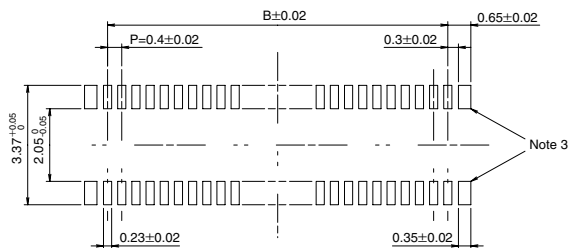

[Specification number]

(51): Embossed tape packaging (5,000 pieces per reel)

Part Number	CL No.	Number of contacts	A	B	C	Unit: mm
						RoHS
DF40C- 10DP-0.4V(51)	684-4035-0-51	10	3.52	1.6	1.0	YES
DF40C- 20DP-0.4V(51)	684-4010-9-51	20	5.52	3.6	1.0	
DF40C- 24DP-0.4V(51)	684-4011-1-51	24	6.32	4.4	1.2	
DF40C- 30DP-0.4V(51)	684-4012-4-51	30	7.52	5.6	1.5	
DF40C- 40DP-0.4V(51)	684-4013-7-51	40	9.52	7.6	3.2	
DF40C- 44DP-0.4V(51)	684-4077-0-51	44	10.32	8.4	3.2	
DF40C- 50DP-0.4V(51)	684-4014-0-51	50	11.52	9.6	3.2	
DF40C- 60DP-0.4V(51)	684-4003-3-51	60	13.52	11.6	3.2	
DF40C- 70DP-0.4V(51)	684-4015-2-51	70	15.52	13.6	3.2	
DF40C- 80DP-0.4V(51)	684-4001-8-51	80	17.52	15.6	3.2	
DF40C-100DP-0.4V(51)	684-4032-1-51	100	21.52	19.6	3.2	

Note 1: Order by number of reels.

Note 2: 60 or 100 positions connectors will not have small interlock indentations in the contact areas.

Note 3: The contacts in each of the 4 corners serve as metal solder brackets only and should NOT be used for current carrying.

Note 4: Location of the HRS logo and cavity identification mark may differ from what is shown.

Note 5: This connector is not polarized.

## ■ Packaging Specification

- Embossed Carrier Tape Dimensions  
 - Receptacle (stacking Height : 1.5mm)

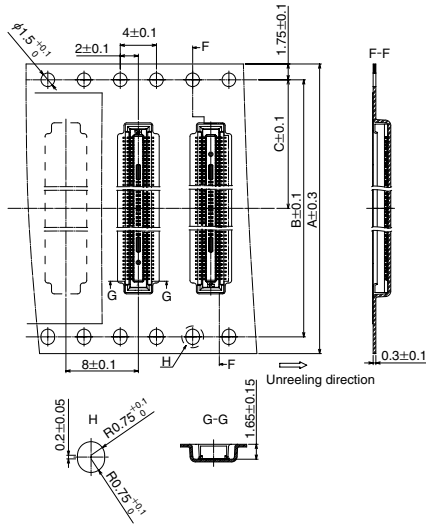

- Reel Dimensions

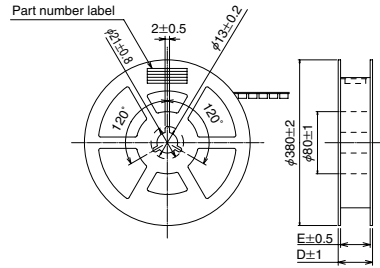

- Stacking Height : 1.5mm

Unit: mm

Part Number	A	B	C	D	E
DF40C- 10DS-0.4V(51)	16.0	—	7.5	21.5	17.5
DF40C- 20DS-0.4V(51)	16.0	—	7.5	21.5	17.5
DF40C- 24DS-0.4V(51)	16.0	—	7.5	21.5	17.5
DF40C- 30DS-0.4V(51)	24.0	—	11.5	29.5	25.5
DF40C- 40DS-0.4V(51)	24.0	—	11.5	29.5	25.5
DF40C- 50DS-0.4V(51)	24.0	—	11.5	29.5	25.5
DF40C- 60DS-0.4V(51)	24.0	—	11.5	29.5	25.5
DF40C- 70DS-0.4V(51)	32.0	28.4	14.2	37.5	33.5
DF40C- 80DS-0.4V(51)	32.0	28.4	14.2	37.5	33.5
DF40C-100DS-0.4V(51)	44.0	40.4	20.2	49.5	45.5

Note : Bottom side deed holes are added to embossed tape when A = 32.0 or greater

● Embossed Carrier Tape Dimensions  
 - Receptacle (stacking Height : 2.0mm to 3.0mm)

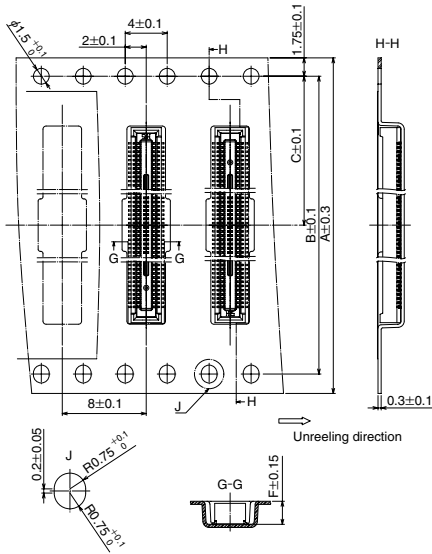

● Reel Dimensions

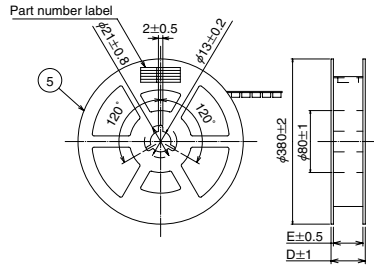

● Stacking Height : 2.0mm

Part Number	Unit: mm					
	A	B	C	D	E	F
DF40C(2.0)-20DS-0.4V(51)	16.0	—	7.5	21.5	17.5	2.2
DF40C(2.0)-30DS-0.4V(51)	24.0	—	11.5	29.5	25.5	2.2
DF40C(2.0)-40DS-0.4V(51)	24.0	—	11.5	29.5	25.5	2.2
DF40C(2.0)-44DS-0.4V(51)	24.0	—	11.5	29.5	25.5	2.2
DF40C(2.0)-50DS-0.4V(51)	24.0	—	11.5	29.5	25.5	2.2
DF40C(2.0)-60DS-0.4V(51)	24.0	—	11.5	29.5	25.5	2.2
DF40C(2.0)-80DS-0.4V(51)	32.0	28.4	14.2	37.5	33.5	2.2

● Stacking Height : 2.5mm

Part Number	Unit: mm					
	A	B	C	D	E	F
DF40HC(2.5)-20DS-0.4V(51)	16.0	—	7.5	21.5	17.5	2.72
DF40HC(2.5)-30DS-0.4V(51)	24.0	—	11.5	29.5	25.5	2.72
DF40HC(2.5)-40DS-0.4V(51)	24.0	—	11.5	29.5	25.5	2.72
DF40HC(2.5)-50DS-0.4V(51)	24.0	—	11.5	29.5	25.5	2.72
DF40HC(2.5)-60DS-0.4V(51)	24.0	—	11.5	29.5	25.5	2.72

● Stacking Height : 3.0mm

Part Number	Unit: mm					
	A	B	C	D	E	F
DF40HC(3.0)-30DS-0.4V(51)	24.0	—	11.5	29.5	25.5	3.15
DF40HC(3.0)-44DS-0.4V(51)	24.0	—	11.5	29.5	25.5	3.15
DF40HC(3.0)-50DS-0.4V(51)	24.0	—	11.5	29.5	25.5	3.15
DF40HC(3.0)-60DS-0.4V(51)	24.0	—	11.5	29.5	25.5	3.15

Note : Bottom side deed holes are added to embossed tape when A = 32.0 or greater





● Embossed Carrier Tape Dimensions - Header

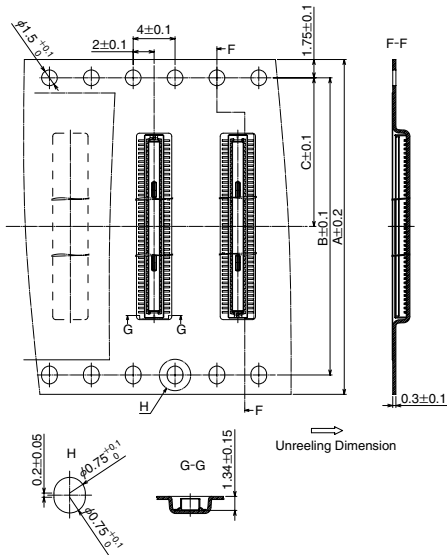

● Reel Dimensions

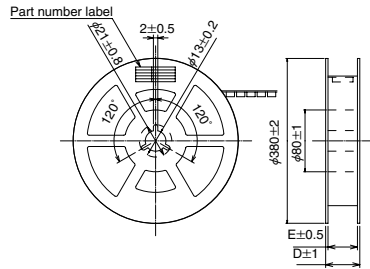

Unit: mm

Part Number	A	B	C	D	E
DF40C- 10DP-0.4V(51)	12.0	—	5.5	17.5	13.5
DF40C- 20DP-0.4V(51)	16.0	—	7.5	21.5	17.5
DF40C- 24DP-0.4V(51)	16.0	—	7.5	21.5	17.5
DF40C- 30DP-0.4V(51)	16.0	—	7.5	21.5	17.5
DF40C- 40DP-0.4V(51)	24.0	—	11.5	29.5	25.5
DF40C- 44DP-0.4V(51)	24.0	—	11.5	29.5	25.5
DF40C- 50DP-0.4V(51)	24.0	—	11.5	29.5	25.5
DF40C- 60DP-0.4V(51)	24.0	—	11.5	29.5	25.5
DF40C- 70DP-0.4V(51)	32.0	28.4	14.2	37.5	33.5
DF40C- 80DP-0.4V(51)	32.0	28.4	14.2	37.5	33.5
DF40C-100DP-0.4V(51)	44.0	40.4	20.2	49.5	45.5

Note : Bottom side deed holes are added to embossed tape when A = 32.0 or greater

## ◆ Usage Recommendations

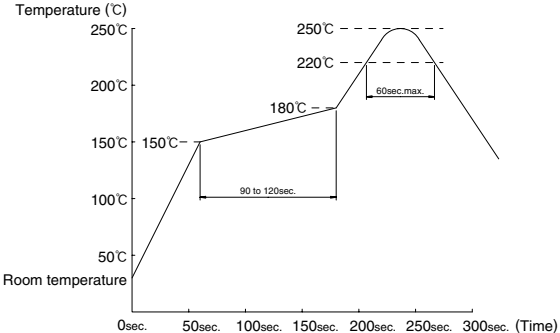
<p>1.Recommended temperature profile</p>	 <p style="text-align: center;">Temperature (°C)</p> <p style="text-align: center;">250°C 220°C 200°C 180°C 150°C 100°C 50°C Room temperature</p> <p style="text-align: center;">0sec. 50sec. 100sec. 150sec. 200sec. 250sec. 300sec. (Time)</p> <p style="text-align: center;">90 to 120sec. 60sec.max.</p> <p>Note 1: Up to 2 cycles of Reflow soldering are possible under the same conditions, provided that there is a return to normal temperature between the first and second cycle.</p> <p>Note 2: The temperature profile indicates the board surface temperature at the point of contacts with the connector terminals.</p>
<p>2.Recommended manual soldering</p>	<p>Manual soldering: 340±10°C for 3 seconds</p>
<p>3.Recommended screen thickness and open area ratio (Pattern area ratio)</p>	<p>Thickness: 0.12 mm Open area ratio: 80%</p>
<p>4.Board warpage</p>	<p>Maximum of 0.02 mm at the connector center, with both ends of the connector as reference points.</p>
<p>5.Cleaning conditions</p>	<p>Cleaning is not recommended. When cleaning, please evaluate as if can deteriorate the performance including mechanical operation and environmental resistance.</p>
<p>6.Precautions</p>	<ul style="list-style-type: none"> <li>* Mating and un-mating of the connectors when not soldered on the boards is not recommended as this may cause deformation of the terminals, damage to the contacts or insulators.</li> <li>■ Mated connectors should not carry weight of the board by themselves. Provide some other support of the boards.</li> <li>■ When mating/un-mating do not twist or lift by the corners. Apply the forces evenly across the entire length and width of the connectors taking care NOT to damage or deform soldered terminations.</li> <li>■ Exercise extreme caution when mating/ un-mating when the connector is mounted on a non-rigid (flexible) substrate.</li> <li>■ Do NOT pull on the flexible substrate.</li> <li>■ Slight discoloration on the insulating materials will not affect form, fit or function of the connectors.</li> </ul>

## Handling Precautions when mating the connectors

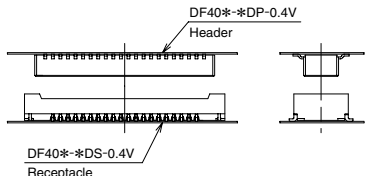
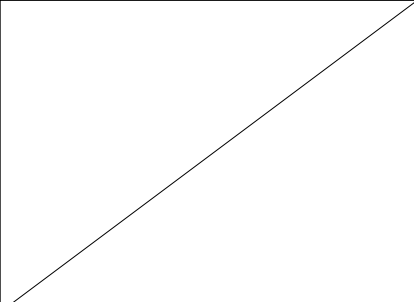
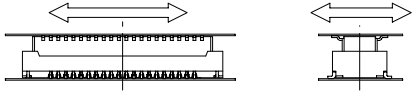
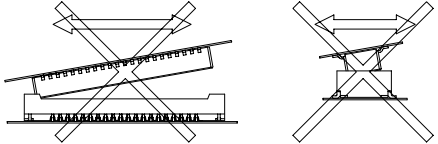
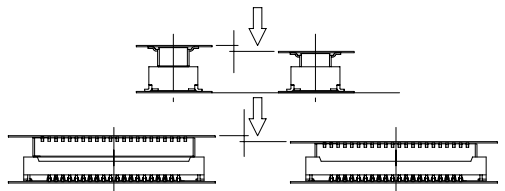
 <p>DF40*-*DP-0.4V Header</p> <p>DF40*-*DS-0.4V Receptacle</p>	
 	<p>Keep the connectors parallel to each other when positioning</p> <p>Do not attempt to mate the connectors starting at one end or side.</p>
	<p>Press-down evenly until slight resistance is felt. Overcoming this slight resistance will complete the mating receptacle with the header. A definite "click" sensation will confirm the fully mated condition.</p>

## ◆ Handling Precautions when un-mating the connectors

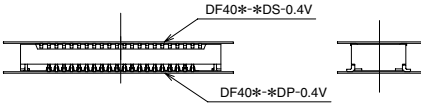
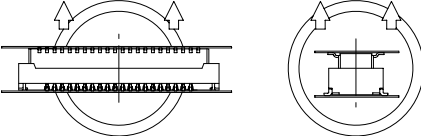
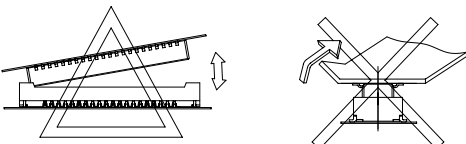
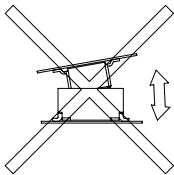
	<p>Fully mated</p>
	<p>Lift even one side, keeping both boards parallel to each other.</p>
 <p>Pitch Orientation</p> <p>Corner Orientation</p>	<p>When handling, circumstances prevent the connector from being kept level during the un-mating. One end may be lifted separate as shown.</p> <p>However, to utilize this procedure the connector must be mounted on a sufficiently rigid circuit board.</p> <p>Any deflection of the board during this operation may result in damage to the connectors or solder joints.</p> <p>Do not attempt the start of the un-mating of the connectors from one side or corner.</p>
 <p>Width Orientation</p>	<p>When un-mating is from the width orientation, as illustrated in the diagram to the left, connector could be damaged. Do not remove from the width orientation.</p>

## Handling Precautions when un-mating the connectors

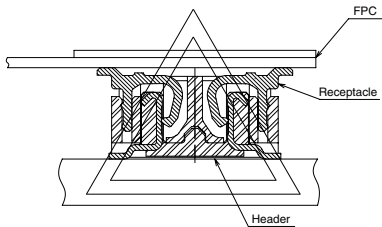

Low rigidity FPC should not be used for mounting of the receptacle.

Un-mating of the connectors when the receptacle is mounted on the extremely flexible FPC can result in solder joint failure or damage to the connector itself.

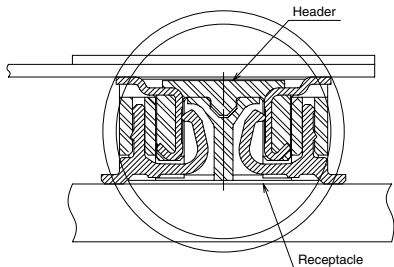

It is highly recommended that the receptacle be mounted on the rigid PCB and the header on the FPC.

Contact HRS when specific application requires mounting of the receptacle on the FPC.

All published performance data is based on connectors mounted on rigid FPC and PCB.

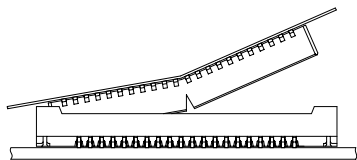

Failure to exercise caution when un-mating connectors mounted on the non-rigid FPC may also result in connector breakage.