

DTM06-12SA-E007 ✓ ACTIVE

DEUTSCH | DEUTSCH DT, DEUTSCH DTM

TE Internal #: DTM06-12SA-E007

Housing for Female Terminals, Wire-to-Wire, 12 Position, .165 in [4.19 mm] Centerline, Sealable, Gray, Wire & Cable, Power & Signal, Hybrid

[View on TE.com >](#)



Connectors > Automotive Connectors > Connector Housings > DEUTSCH DTM HOUSINGS



Connector & Housing Type: **Housing for Female Terminals**

Mating Pin Diameter: **1.02 mm [.04 in]**

Connector System: **Wire-to-Wire**

Number of Positions: **12**

Centerline (Pitch): **4.19 mm [.165 in]**

[All DEUTSCH DTM HOUSINGS \(95\)](#)

Features

Product Type Features

Connector & Housing Shape	Rectangular
Connector & Housing Type	Housing for Female Terminals
Connector System	Wire-to-Wire
Sealable	Yes
Hybrid Connector	No
Primary Locking Feature	Integrated in Housing
Connector & Contact Terminates To	Wire & Cable

Configuration Features

Blank Cavity Position	0
Connector Modification	Shrink Boot Adapter
Number of Positions	12
Number of Rows	2

Electrical Characteristics

Operating Voltage	250 VAC
Nominal Voltage Architecture	12 V, 24 V, 48 V

Body Features



Cable Exit Angle	180°
Body Material	PA GF
Primary Product Color	Gray
Connector Code	A

Contact Features

Contact Size	Size 20
Contact Type	Socket
Mating Pin Diameter	1.02 mm[.04 in]
Contact Current Rating (Max)	7.5 A

Mechanical Attachment

Mounting Feature	Without
Terminal Position Assurance	Yes
Strain Relief	Add By Accessory
Mating Alignment Type	Keyed
Mating Alignment	With
Connector Mounting Type	Cable Mount (Free-Hanging)

Housing Features

Centerline (Pitch)	4.19 mm[.165 in]
--------------------	------------------

Dimensions

Product Width	17.63 mm[.694 in]
Product Length	39.88 mm[1.57 in]
Product Height	40.01 mm[1.575 in]
Row-to-Row Spacing	7.11 mm[.28 in]
Accepts Wire Insulation Diameter Range	1.35 – 3.05 mm[.053 – .12 in]

Usage Conditions

Operating Temperature (Max)	125 °C[257 °F]
Operating Temperature Range	-55 – 125 °C[-67 – 257 °F]

Operation/Application

Circuit Application	Power & Signal
---------------------	----------------

Industry Standards

Agency/Standard	SAE J2030
Degree of Protection	IP68, IP6K9K



UL Flammability Rating	20mm Flame Test per Standard UL-94
------------------------	------------------------------------

Packaging Features

Packaging Quantity	500
--------------------	-----

Packaging Method	Box
------------------	-----

Other

Serviceable	Yes
-------------	-----

Connector Position Assurance Capable	No
--------------------------------------	----

Product Compliance

[For compliance documentation, visit the product page on TE.com>](#)

EU RoHS Directive 2011/65/EU	Compliant
------------------------------	-----------

EU ELV Directive 2000/53/EC	Compliant
-----------------------------	-----------

China RoHS 2 Directive MIIT Order No 32, 2016	No Restricted Materials Above Threshold
---	---

EU REACH Regulation (EC) No. 1907/2006	Current ECHA Candidate List: JUNE 2022 (224) Candidate List Declared Against: JUNE 2022 (224) Does not contain REACH SVHC
--	---

Halogen Content	Not Low Halogen - contains Br or Cl > 900 ppm.
-----------------	--

Solder Process Capability	Not reviewed for solder process capability
---------------------------	--

Product Compliance Disclaimer

This information is provided based on reasonable inquiry of our suppliers and represents our current actual knowledge based on the information they provided. This information is subject to change. The part numbers that TE has identified as EU RoHS compliant have a maximum concentration of 0.1% by weight in homogenous materials for lead, hexavalent chromium, mercury, PBB, PBDE, DBP, BBP, DEHP, DIBP, and 0.01% for cadmium, or qualify for an exemption to these limits as defined in the Annexes of Directive 2011/65/EU (RoHS2). Finished electrical and electronic equipment products will be CE marked as required by Directive 2011/65/EU. Components may not be CE marked. Additionally, the part numbers that TE has identified as EU ELV compliant have a maximum concentration of 0.1% by weight in homogenous materials for lead, hexavalent chromium, and mercury, and 0.01% for cadmium, or qualify for an exemption to these limits as defined in the Annexes of Directive 2000/53/EC (ELV). Regarding the REACH Regulation, the information TE provides on SVHC in articles for this part number is based on the latest European Chemicals Agency (ECHA) 'Guidance on requirements for substances in articles' posted at this URL: <https://echa.europa.eu/guidance-documents/guidance-on-reach>

Compatible Parts



TE Part # CAT-D485-CH8172
DEUTSCH DTM HOUSINGS



TE Part # DT-RT1
EXT TOOL, FRONT RELEASE



TE Part # CAT-D48-SP729
DEUTSCH SEALING PLUGS



TE Part # CAT-D485-H342
DEUTSCH DTM HEADERS



TE Part # CAT-D485-EN17
DEUTSCH PCB ENCLOSURES



TE Part # CAT-D485-W416
DEUTSCH DTM WEDGELOCKS

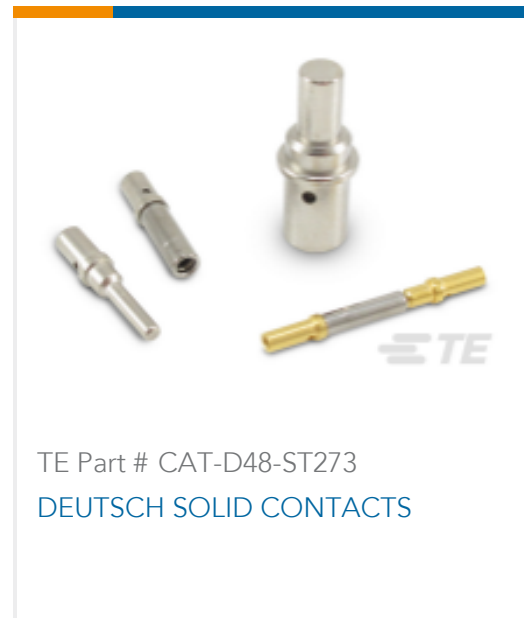

TE Part # CAT-D48-ST273
DEUTSCH SOLID CONTACTS



TE Part # CAT-D48-SFT273
DEUTSCH STAMPED & FORMED CONTACTS



TE Part # 2303064-1
REC, 12P, GRY, N, FLANGE, A



TE Part # DTM04-12PA-EE04
REC, 12P, BLK, N, HIGH TEMP, A

Also in the Series | **DEUTSCH DT**



Automotive Connector Caps & Covers
(98)



Automotive Connector Locks &
Position Assurance(73)

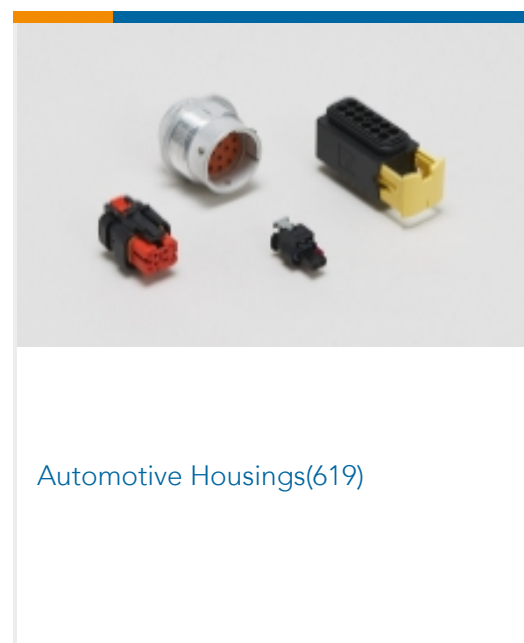

Automotive Housings(619)

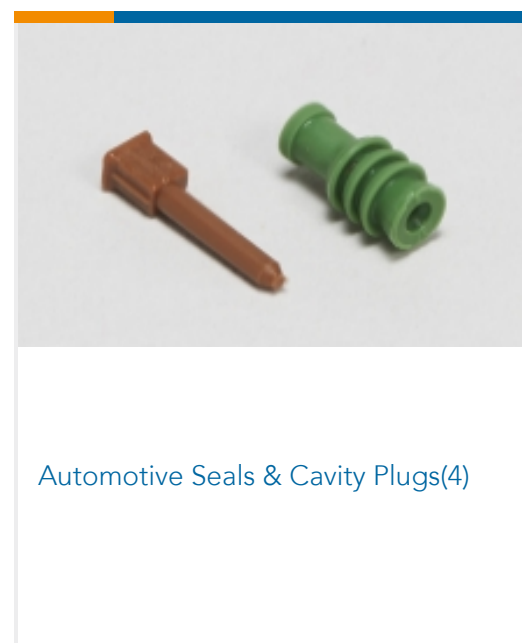

Automotive Seals & Cavity Plugs(4)

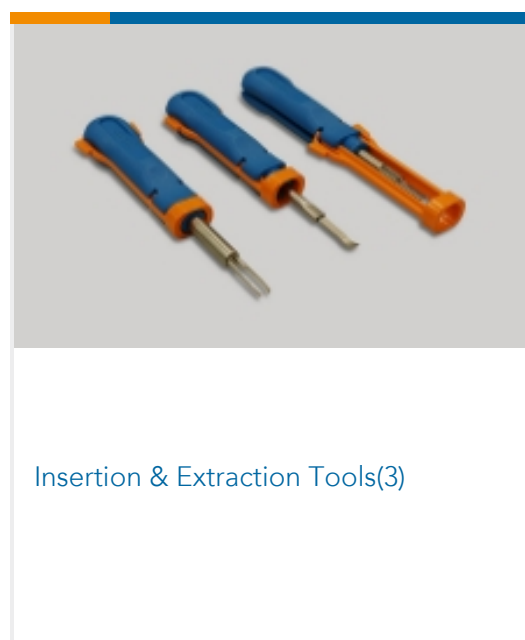

Insertion & Extraction Tools(3)

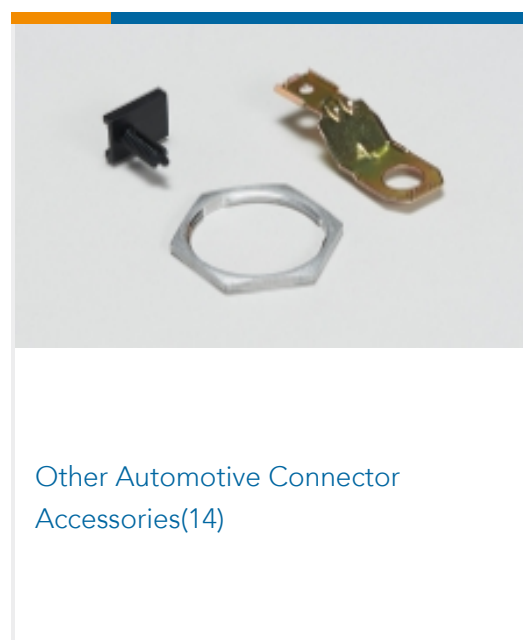

Other Automotive Connector
Accessories(14)



PCB Headers & Receptacles(106)

Also in the Series | **DEUTSCH DTM**



Automotive Connector Caps & Covers
(34)

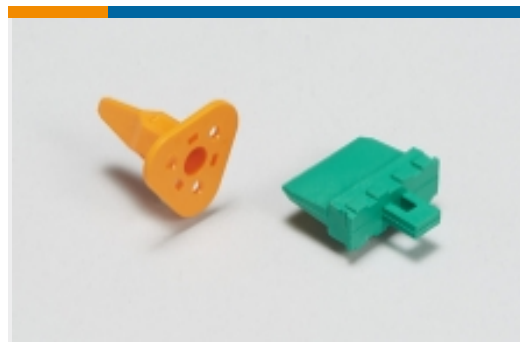

Automotive Connector Locks &
Position Assurance(17)



Automotive Housings(98)



Insertion & Extraction Tools(2)

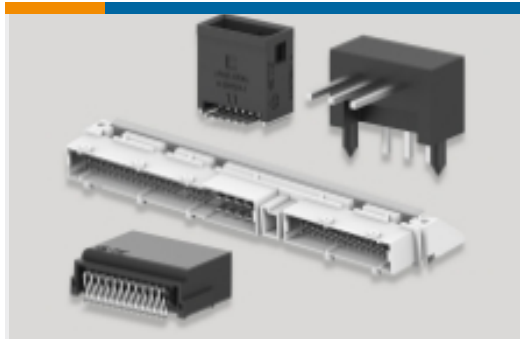

PCB Headers & Receptacles(42)

Customers Also Bought



TE Part #2292865-1
AS16 BACKSHELL, 12P CAP,
SMOOTH EXIT, MC



TE Part #3-2112162-1
21POS,TAB2.8X0.8,TABHSG,CODE C,
ASSY,SLD



TE Part #DTMH06-3SA
PLG, 3P, BLK, N, HI TEMP, A



TE Part #HD34-18-21SN-059
REC,21P,AL,N, CBL CLMP BT, DRAIN,
20,S,MC



TE Part #HDP26-18-20SN-L017
PLG, 20P, BLK, N, RNG, 16/20, S

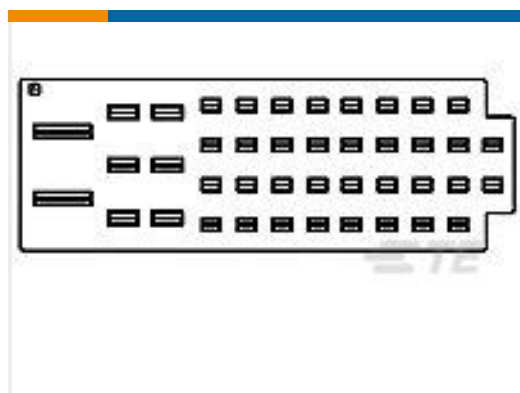

TE Part #967378-1
DICHTUNG



TE Part #2319021-1
REC CONN CVR,8POS,AMP MCP 2.8,
FRB



TE Part #91546-1
CCII 53 SERIES TAPER PIN 20-18 ASSY



TE Part #2500033-1
SRC Power Blind Cavity Plug

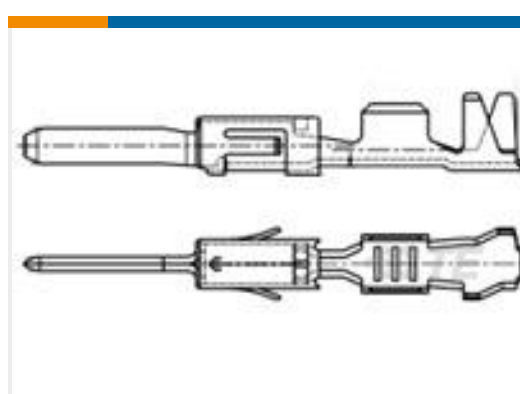

TE Part #963903-1
TAB A 1.6x0.6 CONTACT CS SWS Sn
(LP)

Documents



Product Drawings

[PLG, 12P, GRY, N, XCAP, A](#)

English

CAD Files

[3D PDF](#)

3D

Customer View Model

[ENG_CVM_CVM_DTM06-12SA-E007_99_c-dtm06-12sa-e007-99.2d_dxf.zip](#)

English

Customer View Model

[ENG_CVM_CVM_DTM06-12SA-E007_99_c-dtm06-12sa-e007-99.3d_igs.zip](#)

English

Customer View Model

[ENG_CVM_CVM_DTM06-12SA-E007_99_c-dtm06-12sa-e007-99.3d_stp.zip](#)

English

By downloading the CAD file I accept and agree to the [Terms and Conditions](#) of use.

Datasheets & Catalog Pages

[ICT Terminals and Connectors Catalogue](#)

English

[CONNECTOR SELECTOR](#)

English

Product Specifications

[Application Specification](#)

English

Product Environmental Compliance

[Product Compliance](#)

English

[Product Compliance](#)

English

Agency Approvals

[UL Report](#)

English