

DRAWING FOR REFERENCE: This is subject to change without notice  
08/11/2012

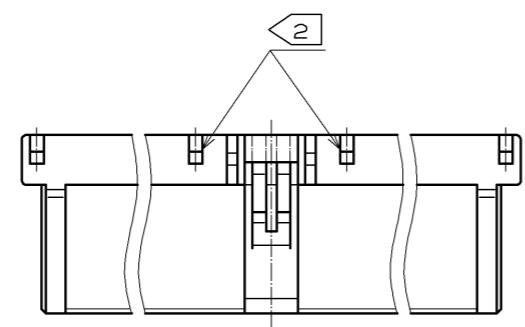

1 FOR DF1E-2S-2.5C

1 FOR DF1E-3S-2.5C

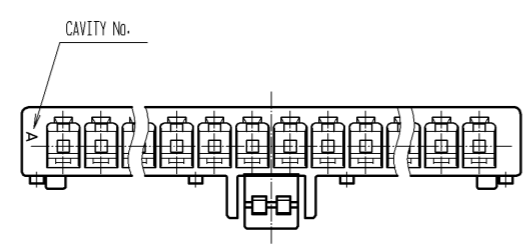
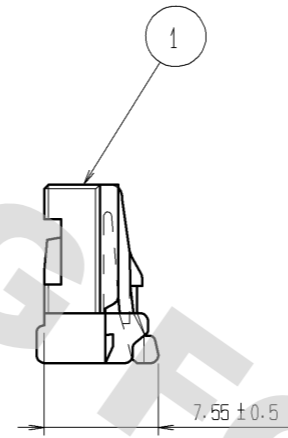
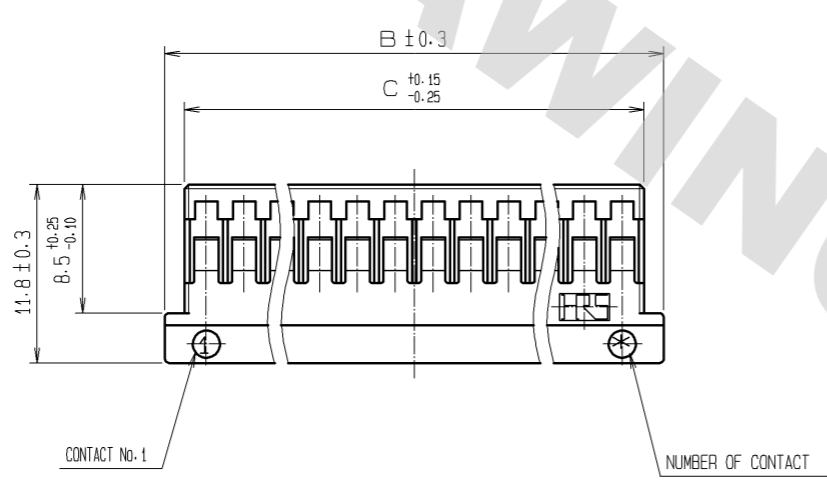
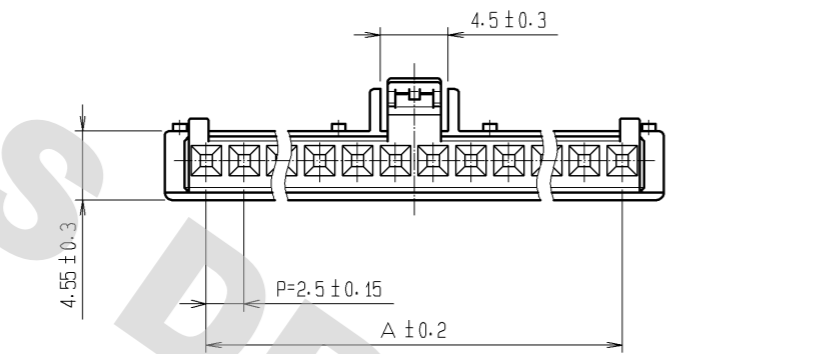
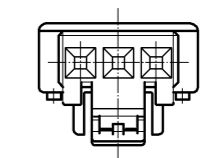
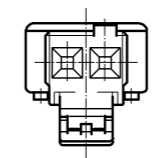
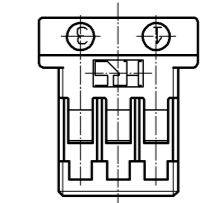
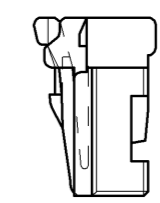
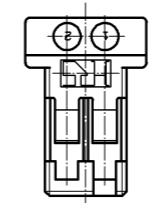
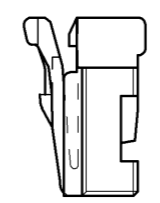

△ PART No.	CODE No.	NUMBER OF CONTACTS	A	B	C
DF1E- 2S-2.5C	CL541-0811-0	2	2.5	8.0	5.4
DF1E- 3S-2.5C	CL541-0812-2	3	5.0	10.5	7.9
DF1E- 4S-2.5C	CL541-0813-5	4	7.5	13.0	10.4
DF1E- 5S-2.5C	CL541-0814-8	5	10.0	15.5	12.9
DF1E- 6S-2.5C	CL541-0815-0	6	12.5	18.0	15.4
DF1E- 7S-2.5C	CL541-0816-3	7	15.0	20.5	17.9
DF1E- 8S-2.5C	CL541-0817-0	8	17.5	23.0	20.4
DF1E- 9S-2.5C	CL541-0818-9	9	20.0	25.5	22.9
DF1E-10S-2.5C	CL541-0819-1	10	22.5	28.0	25.4
DF1E-11S-2.5C	CL541-0820-0	11	25.0	30.5	27.9
DF1E-12S-2.5C	CL541-0821-3	12	27.5	33.0	30.4
DF1E-13S-2.5C	CL541-0822-6	13	30.0	35.5	32.9
DF1E-14S-2.5C	CL541-0823-9	14	32.5	38.0	35.4
DF1E-15S-2.5C	CL541-0824-1	15	35.0	40.5	37.9

NOTES 1 : CONFIGURATION OF DF1E-2S-2.5C AND DF1E-3S-2.5C  
 2 : ONLY APPLICABLE TO PRODUCTS OF 6 POSITIONS AND OVER.  
 (TWO PROTRUSIONS ARE NOT PROVIDED TO PRODUCTS OF 5 POSITIONS AND BELOW.)  
 3 : 1 PACK 100 PIECES.

NO.	MATERIAL	FINISH . REMARKS	NO.	MATERIAL	FINISH . REMARKS
			1	POLYAMIDE	WHITE (NATURAL) . UL94V-0

UNITS	SCALE	COUNT	DESCRIPTION OF REVISIONS	DESIGNED	CHECKED	DATE
mm	2 : 1	3	DIS-H-006008	MI. SAKIMURA	HK. UMEHARA	11. 07. 20

APPROVED : TY. OMA	07. 02. 27	DRAWING NO.	EDC3-161939-01
CHECKED : HK. UMEHARA	07. 02. 27	PART NO.	DF1E- * S-2. 5C
DESIGNED : AH. MIYAZAKI	07. 02. 22	CODE NO.	CL541-
DRAWN : AK. MIURA	07. 02. 22		