



DEUTSCH | DEUTSCH DT

TE Internal #: DT04-12PB-P027

Housing for Male Terminals, Bus Bar-to-Wire, 12 Position, .359 in [9.12 mm] Centerline, Sealable, Black, Bus Bar / Wire & Cable, DEUTSCH DT

[View on TE.com >](#)

Connectors > Automotive Connectors > Connector Housings > DEUTSCH DT Series Housings & Connectors



Connector & Housing Type: **Housing for Male Terminals**

Mating Pin Diameter: **1.59 mm [.063 in]**

Connector System: **Bus Bar-to-Wire**

Number of Positions: **12**

Centerline (Pitch): **9.12 mm [.359 in]**

[All DEUTSCH DT Series Housings & Connectors \(461\)](#)

Features

Product Type Features

Connector & Housing Shape	Rectangular
Connector & Housing Type	Housing for Male Terminals
Connector System	Bus Bar-to-Wire
Sealable	Yes
Hybrid Connector	No
Primary Locking Feature	Integrated in Housing
Connector & Contact Terminates To	Bus Bar, Wire & Cable

Configuration Features

Blank Cavity Position	0
Connector Modification	(2) 6 Pin Busses
Number of Positions	12
Number of Rows	2

Electrical Characteristics

Operating Voltage	250 VAC
Nominal Voltage Architecture	12 V, 24 V, 48 V

Body Features

Cable Exit Angle	180°
------------------	------



Body Material	PA GF
Primary Product Color	Black
Connector Code	B

Contact Features

Contact Type	Pin
Mating Pin Diameter	1.59 mm[.063 in]
Contact Current Rating (Max)	13 A

Mechanical Attachment

Mounting Feature	With
Terminal Position Assurance	Yes
Strain Relief	Add By Accessory
Mating Alignment Type	Keyed
Mating Alignment	With
Connector Mounting Type	Bus Bar Mount

Housing Features

Centerline (Pitch)	9.12 mm[.359 in]
--------------------	------------------

Dimensions

Product Width	40.56 mm[1.597 in]
Product Length	51.89 mm[2.043 in]
Product Height	22.25 mm[.876 in]
Row-to-Row Spacing	4.45 mm[.175 in]

Usage Conditions

Operating Temperature (Max)	125 °C[257 °F]
Operating Temperature Range	-55 – 125 °C[-67 – 257 °F]

Operation/Application

Circuit Application	Power & Signal
---------------------	----------------

Industry Standards

Agency/Standard	SAE J2030
Degree of Protection	IP68, IP6K9K
UL Flammability Rating	12mm Flame Test per Standard UL-94

Packaging Features

--	--



Packaging Quantity	250
--------------------	-----

Packaging Method	Box
------------------	-----

Other

Serviceable	Yes
-------------	-----

Connector Position Assurance Capable	No
--------------------------------------	----

Product Compliance

[For compliance documentation, visit the product page on TE.com>](#)

EU RoHS Directive 2011/65/EU	Compliant
------------------------------	-----------

EU ELV Directive 2000/53/EC	Compliant
-----------------------------	-----------

China RoHS 2 Directive MIIT Order No 32, 2016	No Restricted Materials Above Threshold
---	---

EU REACH Regulation (EC) No. 1907/2006	Current ECHA Candidate List: JUNE 2022 (224) Candidate List Declared Against: JUL 2021 (219) SVHC > Threshold: Not Yet Reviewed
--	--

Halogen Content	Not Low Halogen - contains Br or Cl > 900 ppm.
-----------------	--

Solder Process Capability	Not reviewed for solder process capability
---------------------------	--

Product Compliance Disclaimer

This information is provided based on reasonable inquiry of our suppliers and represents our current actual knowledge based on the information they provided. This information is subject to change. The part numbers that TE has identified as EU RoHS compliant have a maximum concentration of 0.1% by weight in homogenous materials for lead, hexavalent chromium, mercury, PBB, PBDE, DBP, BBP, DEHP, DIBP, and 0.01% for cadmium, or qualify for an exemption to these limits as defined in the Annexes of Directive 2011/65/EU (RoHS2). Finished electrical and electronic equipment products will be CE marked as required by Directive 2011/65/EU. Components may not be CE marked. Additionally, the part numbers that TE has identified as EU ELV compliant have a maximum concentration of 0.1% by weight in homogenous materials for lead, hexavalent chromium, and mercury, and 0.01% for cadmium, or qualify for an exemption to these limits as defined in the Annexes of Directive 2000/53/EC (ELV). Regarding the REACH Regulation, the information TE provides on SVHC in articles for this part number is based on the latest European Chemicals Agency (ECHA) 'Guidance on requirements for substances in articles' posted at this URL: <https://echa.europa.eu/guidance-documents/guidance-on-reach>

Compatible Parts



TE Part # CAT-D487-CH8172
DEUTSCH DT Series Housings & Connectors



TE Part # CAT-D487-M8649
DEUTSCH DT MOUNTING CLIPS



TE Part # CAT-D487-P729
DEUTSCH DT DUST CAPS



TE Part # 1924487-2
MOUNTING CLIP, AMPSEAL 16

Also in the Series | DEUTSCH DT



Automotive Connector Caps & Covers (98)

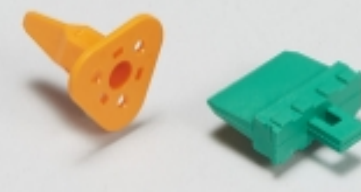

Automotive Connector Locks & Position Assurance(73)



Automotive Housings(619)



Automotive Seals & Cavity Plugs(4)



Insertion & Extraction Tools(3)



Other Automotive Connector Accessories(14)



PCB Headers & Receptacles(106)

Customers Also Bought



TE Part #HD36-18-21SN-059
DEUTSCH HD30 HOUSINGS



TE Part #60774-1
SPADE TERMINAL 18-14 AWG BR



TE Part #42399-1
110 FASTON REC 20-18 AWG TPBR



TE Part #DT04-08PA-P021
DEUTSCH DT Series Housings & Connectors



TE Part #DRB12-128PBE-L018
DEUTSCH DRB HOUSINGS



Documents

Product Drawings

[REC, 12P, BLK, BUSBAR 2X6, GOLD, B](#)

English

CAD Files

[3D PDF](#)

3D

Customer View Model

[ENG_CVM_CVM_DT04-12PB-P027_A.2d_dxf.zip](#)

English

Customer View Model

[ENG_CVM_CVM_DT04-12PB-P027_A.3d_igs.zip](#)

English

Customer View Model

[ENG_CVM_CVM_DT04-12PB-P027_A.3d_stp.zip](#)

English

By downloading the CAD file I accept and agree to the [Terms and Conditions](#) of use.

Datasheets & Catalog Pages

[ICT Terminals and Connectors Catalogue](#)

English

[CONNECTOR SELECTOR](#)

English

Product Specifications

[Application Specification](#)

English

Agency Approvals

[UL Report](#)

English