

DT04-08PA-E008 ✓ ACTIVE

DEUTSCH | DEUTSCH DT

TE Internal #: DT04-08PA-E008

Housing for Male Terminals, Wire-to-Wire, 8 Position, .359 in [9.12 mm] Centerline, Sealable, Gray, Wire & Cable, Power & Signal, DEUTSCH DT

[View on TE.com >](#)



Connectors > Automotive Connectors > Connector Housings > DEUTSCH DT Series Housings & Connectors



Connector & Housing Type: **Housing for Male Terminals**

Mating Pin Diameter: **1.59 mm [.063 in]**

Connector System: **Wire-to-Wire**

Number of Positions: **8**

Centerline (Pitch): **9.12 mm [.359 in]**

[All DEUTSCH DT Series Housings & Connectors \(461\)](#)

Features

Product Type Features

Connector & Housing Shape	Rectangular
Connector & Housing Type	Housing for Male Terminals
Connector System	Wire-to-Wire
Sealable	Yes
Hybrid Connector	No
Primary Locking Feature	Integrated in Housing
Connector & Contact Terminates To	Wire & Cable

Configuration Features

Blank Cavity Position	0
Connector Modification	Shrink Boot Adapter
Number of Positions	8
Number of Rows	2

Electrical Characteristics

Operating Voltage	250 VAC
Nominal Voltage Architecture	12 V, 24 V, 48 V

Body Features

Cable Exit Angle	180°
------------------	------



Body Material	PA GF
Primary Product Color	Gray
Connector Code	A

Contact Features

Contact Size	Size 16
Contact Type	Pin
Mating Pin Diameter	1.59 mm[.063 in]
Contact Current Rating (Max)	13 A

Mechanical Attachment

Mounting Feature	With
Terminal Position Assurance	Yes
Strain Relief	Add By Accessory
Mating Alignment Type	Keyed
Mating Alignment	With
Connector Mounting Type	Cable Mount (Free-Hanging)

Housing Features

Centerline (Pitch)	9.12 mm[.359 in]
--------------------	------------------

Dimensions

Product Width	36.45 mm[1.435 in]
Product Length	59 mm[2.323 in]
Product Height	23.88 mm[.94 in]
Row-to-Row Spacing	4.45 mm[.175 in]
Accepts Wire Insulation Diameter Range	2.23 – 3.68 mm[.088 – .145 in]

Usage Conditions

Operating Temperature (Max)	125 °C[257 °F]
Operating Temperature Range	-55 – 125 °C[-67 – 257 °F]

Operation/Application

Circuit Application	Power & Signal
---------------------	----------------

Industry Standards

Agency/Standard	SAE J2030
Degree of Protection	IP68, IP6K9K
UL Flammability Rating	12mm Flame Test per Standard UL-94



Packaging Features

Packaging Quantity	250
Packaging Method	Box

Other

Serviceable	Yes
Connector Position Assurance Capable	No

Product Compliance

[For compliance documentation, visit the product page on TE.com>](#)

EU RoHS Directive 2011/65/EU	Compliant
EU ELV Directive 2000/53/EC	Compliant
China RoHS 2 Directive MIIT Order No 32, 2016	No Restricted Materials Above Threshold
EU REACH Regulation (EC) No. 1907/2006	Current ECHA Candidate List: JUNE 2022 (224) Candidate List Declared Against: JAN 2022 (223) SVHC > Threshold: Not Yet Reviewed
Halogen Content	Not Low Halogen - contains Br or Cl > 900 ppm.
Solder Process Capability	Not reviewed for solder process capability

Product Compliance Disclaimer

This information is provided based on reasonable inquiry of our suppliers and represents our current actual knowledge based on the information they provided. This information is subject to change. The part numbers that TE has identified as EU RoHS compliant have a maximum concentration of 0.1% by weight in homogenous materials for lead, hexavalent chromium, mercury, PBB, PBDE, DBP, BBP, DEHP, DIBP, and 0.01% for cadmium, or qualify for an exemption to these limits as defined in the Annexes of Directive 2011/65/EU (RoHS2). Finished electrical and electronic equipment products will be CE marked as required by Directive 2011/65/EU. Components may not be CE marked. Additionally, the part numbers that TE has identified as EU ELV compliant have a maximum concentration of 0.1% by weight in homogenous materials for lead, hexavalent chromium, and mercury, and 0.01% for cadmium, or qualify for an exemption to these limits as defined in the Annexes of Directive 2000/53/EC (ELV). Regarding the REACH Regulation, the information TE provides on SVHC in articles for this part number is based on the latest European Chemicals Agency (ECHA) 'Guidance on requirements for substances in articles' posted at this URL: <https://echa.europa.eu/guidance-documents/guidance-on-reach>

Compatible Parts

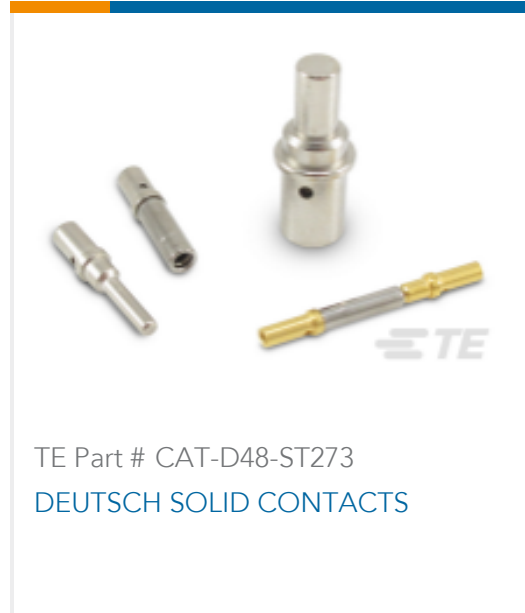
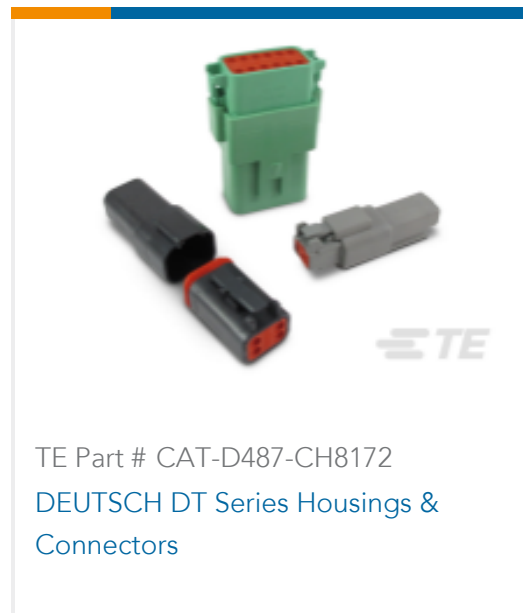

Also in the Series | **DEUTSCH DT**

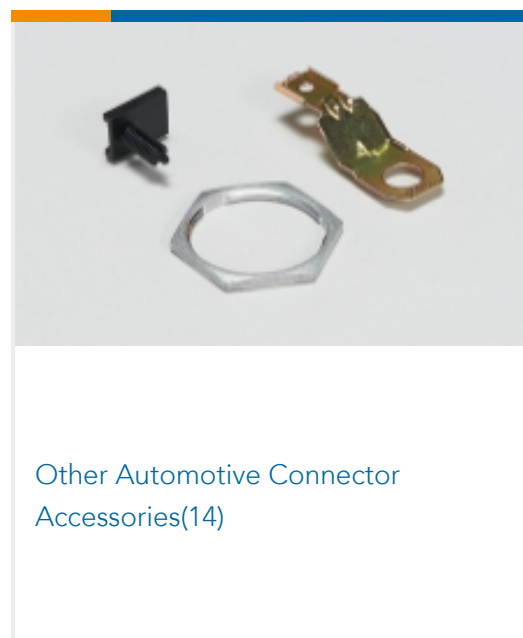
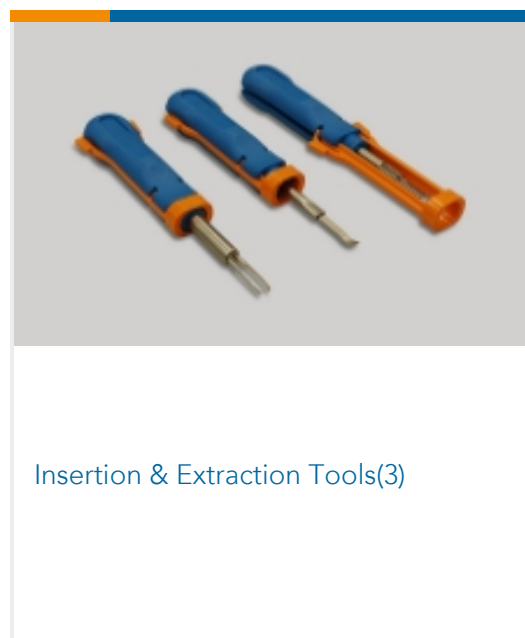
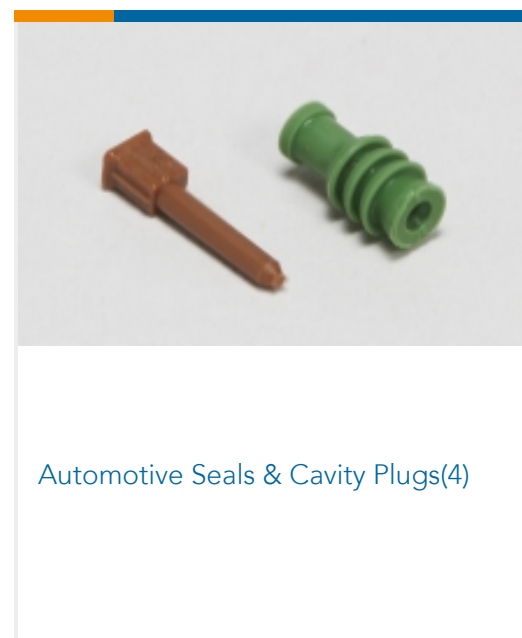
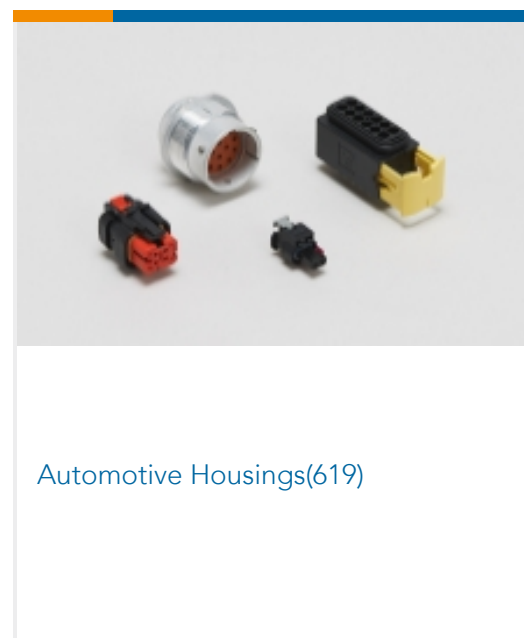
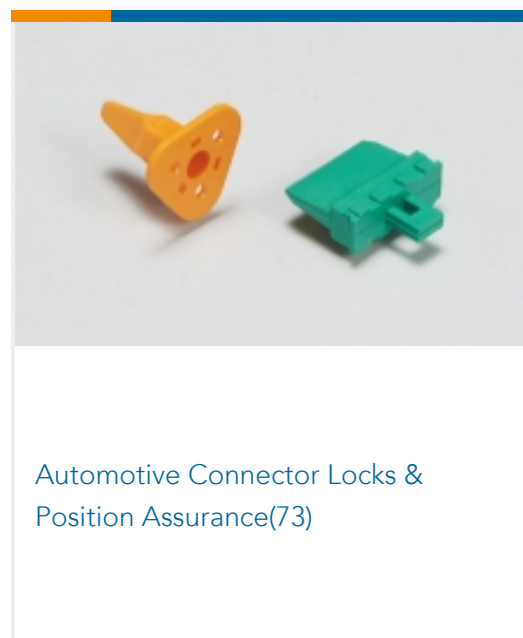

Customers Also Bought

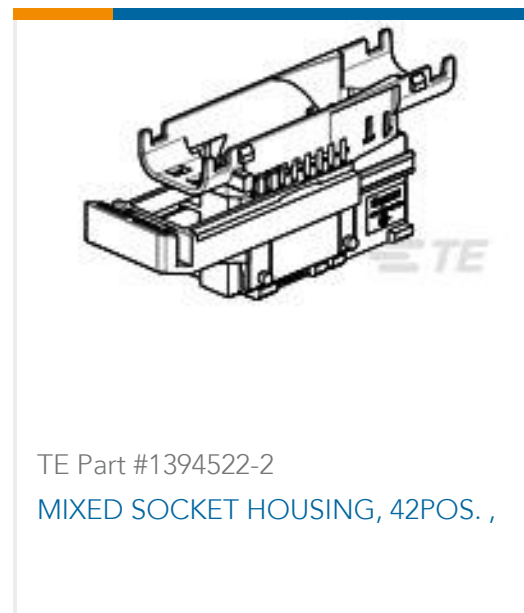

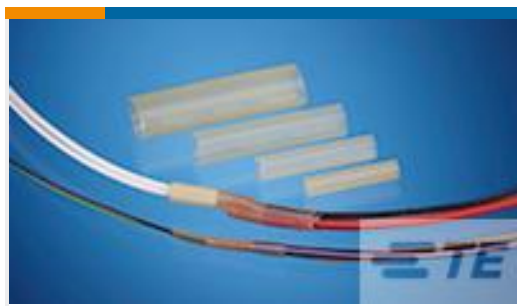

TE Part #3257456005
RBK-VWS-125-NR2-X-40MM



TE Part #1438136-4
GET PCM 70 WAY Plug ASSY Key D

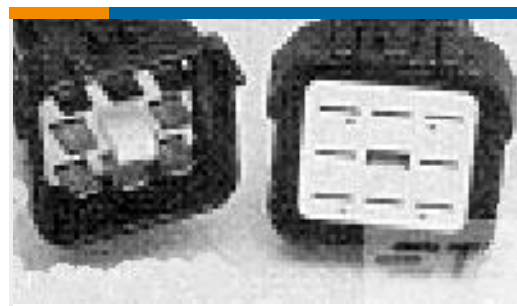

TE Part #344073-1
8 WAY TAB HSG.BLACK

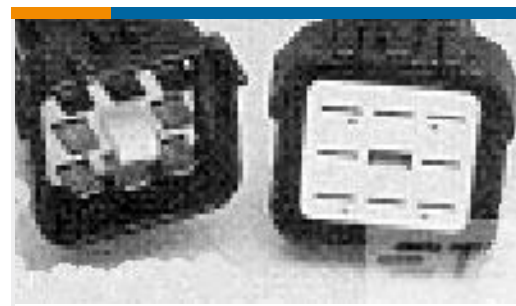

TE Part #344086-1
8 WAY TAB ANTI-BACKOUT



TE Part #966500-1
JPT GEH KOMPL 24P

Documents

CAD Files

[3D PDF](#)

[3D](#)

[Customer View Model](#)

[ENG_CVM_CVM_DT04-08PA-E008_A.2d_dxf.zip](#)

English

[Customer View Model](#)

[ENG_CVM_CVM_DT04-08PA-E008_A.3d_igs.zip](#)

English

[Customer View Model](#)

[ENG_CVM_CVM_DT04-08PA-E008_A.3d_stp.zip](#)

English

By downloading the CAD file I accept and agree to the [Terms and Conditions](#) of use.

Datasheets & Catalog Pages

[ICT Terminals and Connectors Catalogue](#)

English

[CONNECTOR SELECTOR](#)

English

Product Specifications

[Application Specification](#)

English

Product Environmental Compliance

[Product Compliance](#)

English



[Product Compliance](#)

English

[Agency Approvals](#)

[UL Report](#)

English