

DTM06-3S-E004 ✓ ACTIVE

DEUTSCH | DEUTSCH DT, DEUTSCH DTM

TE Internal #: DTM06-3S-E004

Housing for Female Terminals, Wire-to-Wire, 3 Position, .165 in [4.19 mm] Centerline, Sealable, Black, Wire & Cable, Power & Signal, Hybrid

[View on TE.com >](#)



Connectors > Automotive Connectors > Connector Housings > DEUTSCH DTM HOUSINGS



Connector & Housing Type: **Housing for Female Terminals**

Mating Pin Diameter: **1.02 mm [.04 in]**

Connector System: **Wire-to-Wire**

Number of Positions: **3**

Centerline (Pitch): **4.19 mm [.165 in]**

[All DEUTSCH DTM HOUSINGS \(95\)](#)

Features

Product Type Features

Connector & Housing Shape	Rectangular
Connector & Housing Type	Housing for Female Terminals
Connector System	Wire-to-Wire
Sealable	Yes
Hybrid Connector	No
Primary Locking Feature	Integrated in Housing
Connector & Contact Terminates To	Wire & Cable

Configuration Features

Blank Cavity Position	0
Number of Positions	3
Number of Rows	1

Electrical Characteristics

Operating Voltage	250 VAC
Nominal Voltage Architecture	12 V, 24 V, 48 V

Body Features

Cable Exit Angle	180°
Body Material	PA GF



Primary Product Color	Black
-----------------------	-------

Contact Features

Contact Size	Size 20
--------------	---------

Contact Type	Socket
--------------	--------

Mating Pin Diameter	1.02 mm[.04 in]
---------------------	-----------------

Contact Current Rating (Max)	7.5 A
------------------------------	-------

Mechanical Attachment

Mounting Feature	Without
------------------	---------

Terminal Position Assurance	Yes
-----------------------------	-----

Strain Relief	Add By Accessory
---------------	------------------

Mating Alignment Type	Polarization Slot
-----------------------	-------------------

Mating Alignment	With
------------------	------

Connector Mounting Type	Cable Mount (Free-Hanging)
-------------------------	----------------------------

Housing Features

Centerline (Pitch)	4.19 mm[.165 in]
--------------------	------------------

Dimensions

Product Width	16.26 mm[.64 in]
---------------	------------------

Product Length	27.56 mm[1.085 in]
----------------	--------------------

Product Height	14 mm[.551 in]
----------------	----------------

Accepts Wire Insulation Diameter Range	1.35 – 3.05 mm[.053 – .12 in]
--	-------------------------------

Usage Conditions

Operating Temperature (Max)	125 °C[257 °F]
-----------------------------	----------------

Operating Temperature Range	-55 – 125 °C[-67 – 257 °F]
-----------------------------	----------------------------

Operation/Application

Circuit Application	Power & Signal
---------------------	----------------

Industry Standards

Agency/Standard	SAE J2030
-----------------	-----------

Degree of Protection	IP68, IP6K9K
----------------------	--------------

UL Flammability Rating	20mm Flame Test per Standard UL-94
------------------------	------------------------------------

Packaging Features

Packaging Quantity	2000
--------------------	------



Packaging Method Box

Other

Serviceable Yes

Connector Position Assurance Capable No

Product Compliance

[For compliance documentation, visit the product page on TE.com>](#)

EU RoHS Directive 2011/65/EU Compliant

EU ELV Directive 2000/53/EC Compliant

China RoHS 2 Directive MIIT Order No 32, 2016 No Restricted Materials Above Threshold

EU REACH Regulation (EC) No. 1907/2006 Current ECHA Candidate List: JUNE 2022 (224)
Candidate List Declared Against: JUNE 2022 (224)
Does not contain REACH SVHC

Halogen Content Not Low Halogen - contains Br or Cl > 900 ppm.

Solder Process Capability Not reviewed for solder process capability

Product Compliance Disclaimer

This information is provided based on reasonable inquiry of our suppliers and represents our current actual knowledge based on the information they provided. This information is subject to change. The part numbers that TE has identified as EU RoHS compliant have a maximum concentration of 0.1% by weight in homogenous materials for lead, hexavalent chromium, mercury, PBB, PBDE, DBP, BBP, DEHP, DIBP, and 0.01% for cadmium, or qualify for an exemption to these limits as defined in the Annexes of Directive 2011/65/EU (RoHS2). Finished electrical and electronic equipment products will be CE marked as required by Directive 2011/65/EU. Components may not be CE marked. Additionally, the part numbers that TE has identified as EU ELV compliant have a maximum concentration of 0.1% by weight in homogenous materials for lead, hexavalent chromium, and mercury, and 0.01% for cadmium, or qualify for an exemption to these limits as defined in the Annexes of Directive 2000/53/EC (ELV). Regarding the REACH Regulation, the information TE provides on SVHC in articles for this part number is based on the latest European Chemicals Agency (ECHA) 'Guidance on requirements for substances in articles' posted at this URL: <https://echa.europa.eu/guidance-documents/guidance-on-reach>

Compatible Parts



TE Part # CAT-D485-CH8172
DEUTSCH DTM HOUSINGS



TE Part # WM-3S
WEDGE LOCK, 3P, PLG, ORG, DTM



TE Part # DT-RT1
EXT TOOL, FRONT RELEASE



TE Part # CAT-D48-SP729
DEUTSCH SEALING PLUGS

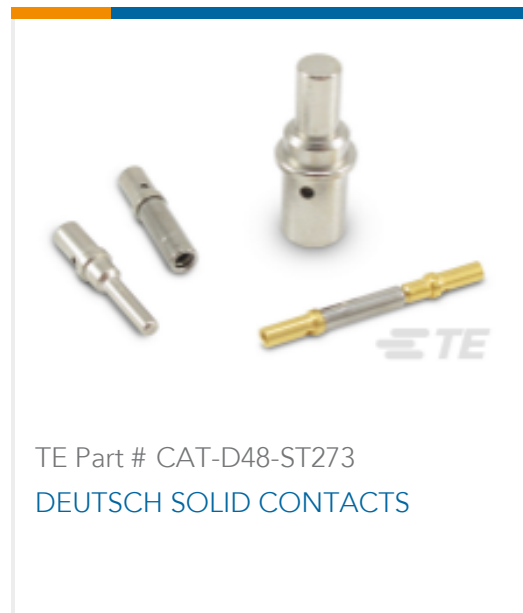

Also in the Series | **DEUTSCH DT**

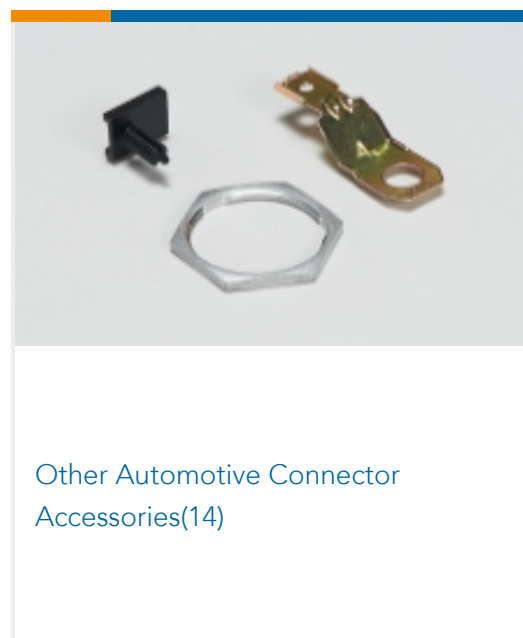
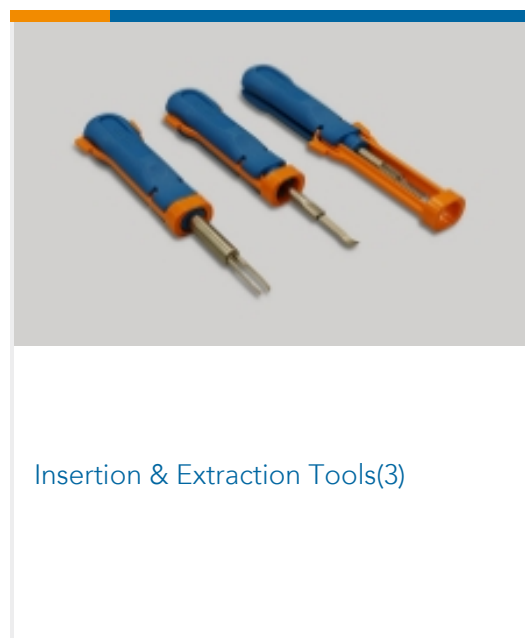
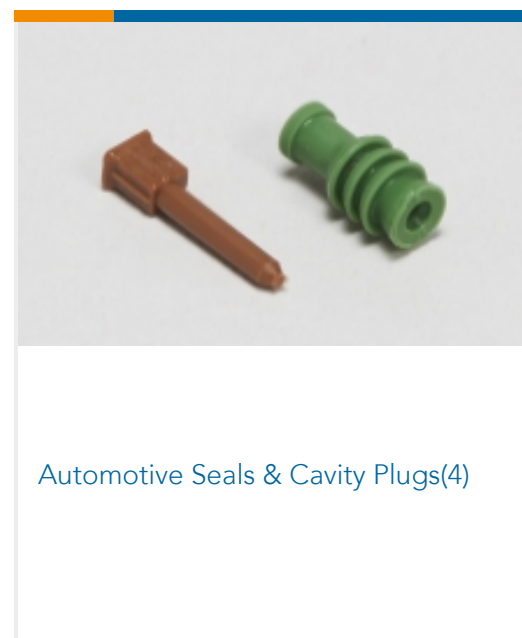
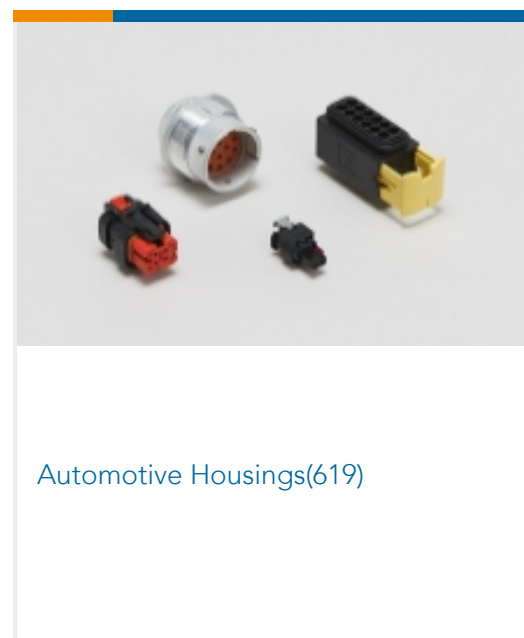
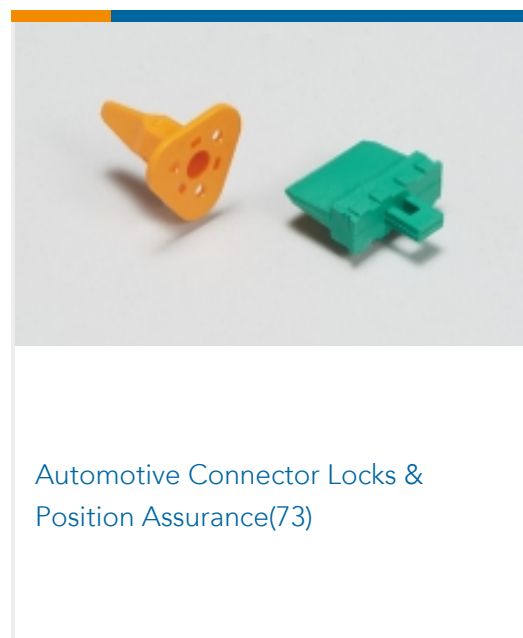

Also in the Series | **DEUTSCH DTM**



Automotive Connector Caps & Covers (34)

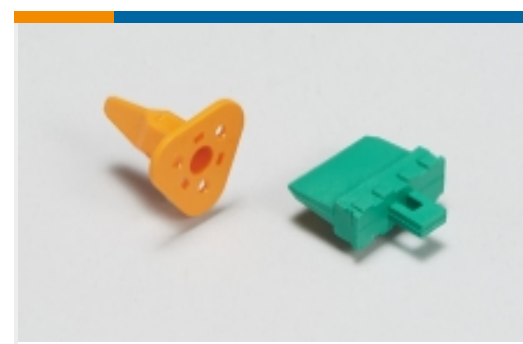

Automotive Connector Locks & Position Assurance (17)

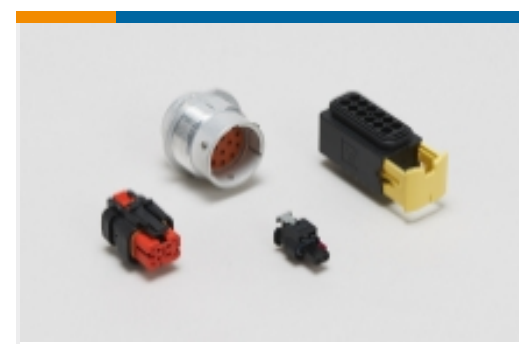

Automotive Housings (98)



Insertion & Extraction Tools (2)

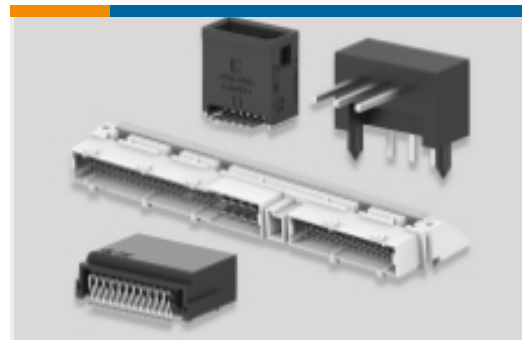

PCB Headers & Receptacles (42)

Customers Also Bought

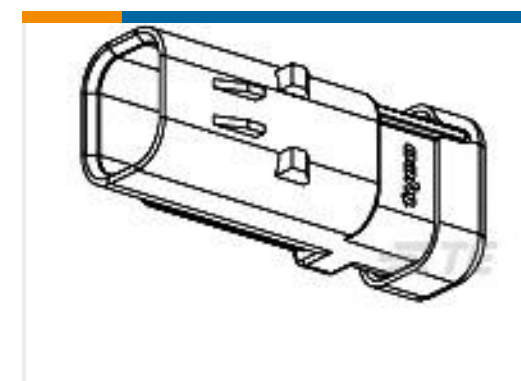
TE Part #DTM04-2P-E004
DEUTSCH DTM HOUSINGSTE Part #WM-3S
DEUTSCH DTM WEDGELOCKSTE Part #2-31811-5
TERMINAL, SOLIS R 4 1/4TE Part #776430-1
AS 16, 3P CAP ASSY, KEY 1

Documents

Product Drawings

PLG, 3P, BLK, N

English

CAD Files

Customer View Model

[ENG_CVM_CVM_DTM06-3S-E004_99.2d_dxf.zip](#)

English

3D PDF

3D

Customer View Model

[ENG_CVM_CVM_DTM06-3S-E004_99.3d_igs.zip](#)

English

Customer View Model

[ENG_CVM_CVM_DTM06-3S-E004_99.3d_stp.zip](#)

English

By downloading the CAD file I accept and agree to the [Terms and Conditions](#) of use.



Datasheets & Catalog Pages

[ICT Terminals and Connectors Catalogue](#)

English

[CONNECTOR SELECTOR](#)

English

Product Specifications

[Application Specification](#)

English

Product Environmental Compliance

[MD_DTM06-3S-E004_08212017548_dmtec](#)

English

[MD_DTM06-3S-E004_08212017548_dmtec](#)

English

Agency Approvals

[UL Report](#)

English