

926635-2 ✓ ACTIVE

AMPMODU | AMPMODU IV/V

TE Internal #: 926635-2

PCB Latches, Locks & Retainers, Locking Device, Signal, -65 – 105 °

C [-85 – 221 °F], AMPMODU IV/V

[View on TE.com >](#)



Connectors > PCB Connectors > PCB Connector Accessories > PCB Connector Hardware > PCB Latches, Locks & Retainers

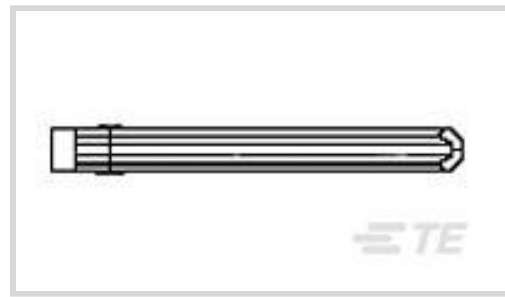

Connector & Contact Retention Accessory Type: **Locking Device**

Contact Current Rating (Max): **3 A**

Circuit Application: **Signal**

Operating Temperature Range: **-65 – 105 °C [-85 – 221 °F]**

## Features

### Product Type Features

Connector & Contact Retention Accessory Type	Locking Device
--	----------------

### Body Features

Primary Product Material	Polyamide 6.6 GF
--------------------------	------------------

Primary Product Color	Red
-----------------------	-----

### Contact Features

Contact Current Rating (Max)	3 A
------------------------------	-----

### Usage Conditions

Operating Temperature Range	-65 – 105 °C[-85 – 221 °F]
-----------------------------	----------------------------

### Operation/Application

Circuit Application	Signal
---------------------	--------

### Industry Standards

Glow Wire Rating	Standard Part - Not Glow Wire
------------------	-------------------------------

### Packaging Features

Packaging Quantity	2000
--------------------	------

Packaging Method	Box
------------------	-----

## Product Compliance

[For compliance documentation, visit the product page on TE.com>](#)

EU RoHS Directive 2011/65/EU	Compliant
------------------------------	-----------



EU ELV Directive 2000/53/EC

Not Yet Reviewed

China RoHS 2 Directive MIIT Order No 32, 2016

No Restricted Materials Above Threshold

EU REACH Regulation (EC) No. 1907/2006

Current ECHA Candidate List: JUNE 2022 (224)  
 Candidate List Declared Against: JUL 2021 (219)  
 SVHC > Threshold:  
 Not Yet Reviewed

Halogen Content

Low Halogen - Br, Cl, F, I < 900 ppm per homogenous material. Also BFR/CFR/PVC Free

Solder Process Capability

Not applicable for solder process capability

Product Compliance Disclaimer

This information is provided based on reasonable inquiry of our suppliers and represents our current actual knowledge based on the information they provided. This information is subject to change. The part numbers that TE has identified as EU RoHS compliant have a maximum concentration of 0.1% by weight in homogenous materials for lead, hexavalent chromium, mercury, PBB, PBDE, DBP, BBP, DEHP, DIBP, and 0.01% for cadmium, or qualify for an exemption to these limits as defined in the Annexes of Directive 2011/65/EU (RoHS2). Finished electrical and electronic equipment products will be CE marked as required by Directive 2011/65/EU. Components may not be CE marked. Additionally, the part numbers that TE has identified as EU ELV compliant have a maximum concentration of 0.1% by weight in homogenous materials for lead, hexavalent chromium, and mercury, and 0.01% for cadmium, or qualify for an exemption to these limits as defined in the Annexes of Directive 2000/53/EC (ELV). Regarding the REACH Regulation, the information TE provides on SVHC in articles for this part number is based on the latest European Chemicals Agency (ECHA) 'Guidance on requirements for substances in articles' posted at this URL: <https://echa.europa.eu/guidance-documents/guidance-on-reach>

## Compatible Parts



## Also in the Series | AMPMODU IV/V

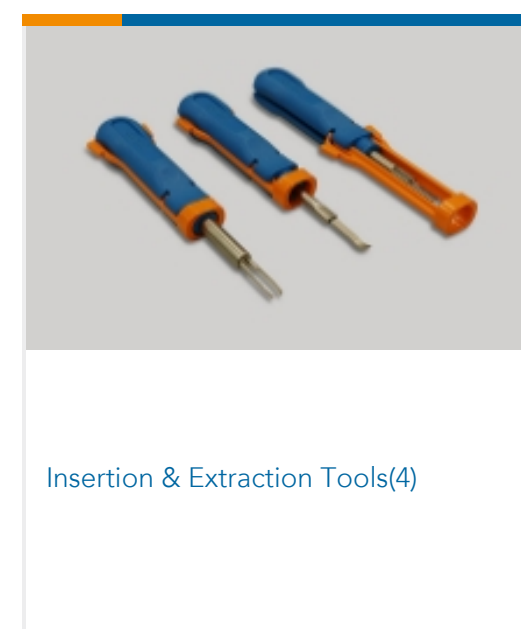
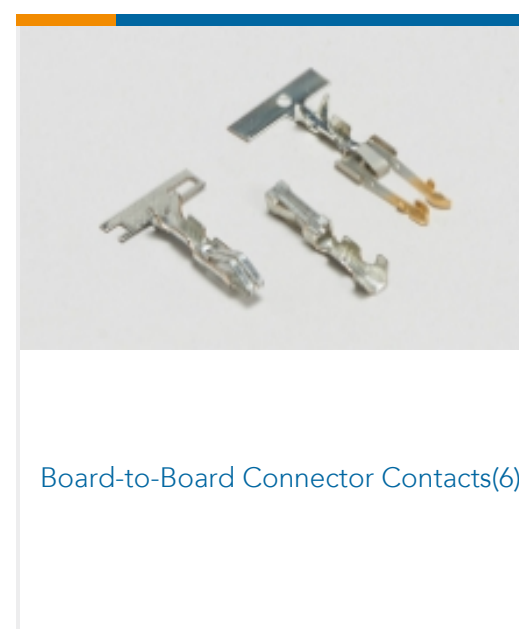
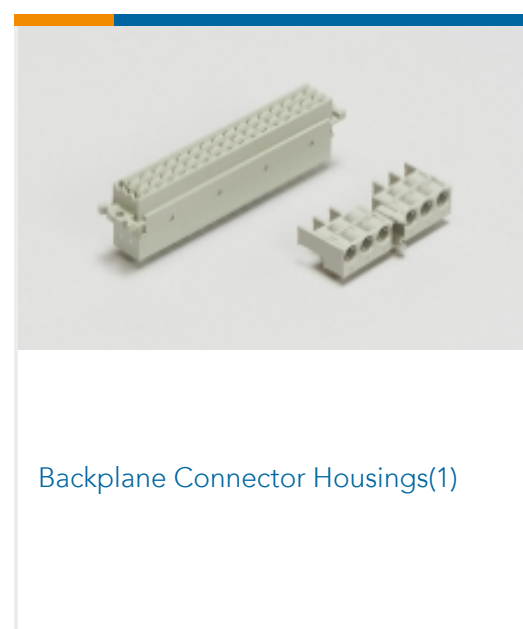
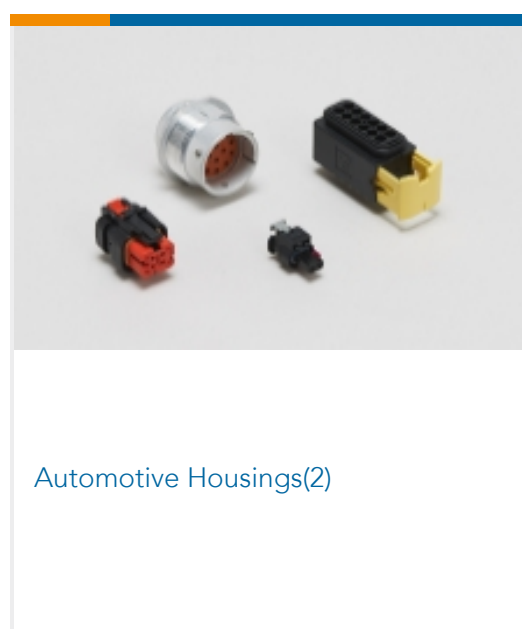

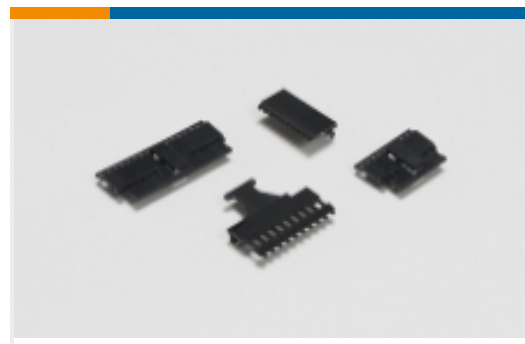

PCB Connector Covers(18)



PCB Connector Keying(6)



PCB Connector Mounting(1)

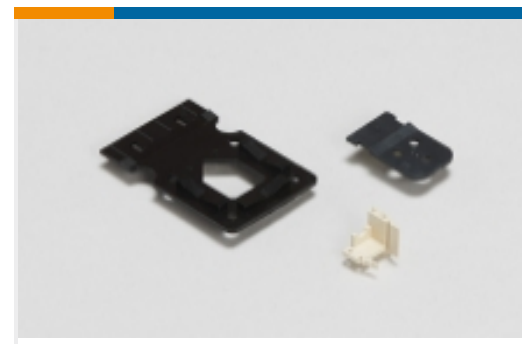

PCB Connector Strain Relief(3)

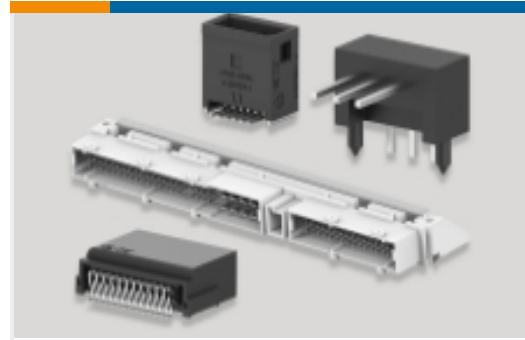

PCB Headers & Receptacles(939)

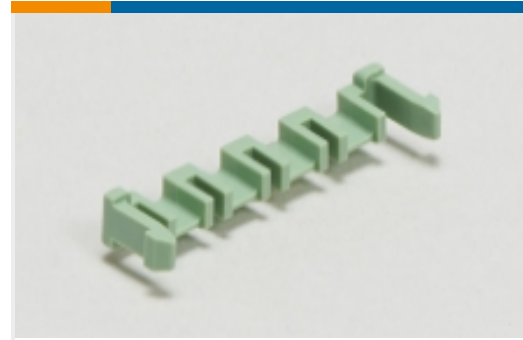

PCB Latches, Locks & Retainers(9)



Rectangular Connector Housings(5)



Standard Rectangular Connectors(8)



Wire-to-Board Connector Assemblies & Housings(467)



Wire-to-Board Connector Contacts (326)

## Customers Also Bought



TE Part #DT04-2P  
DEUTSCH DT Series Housings & Connectors



TE Part #W2S  
DEUTSCH DT WEDGELOCKS



TE Part #282104-1  
AMP SUPERSEAL 1.5MM,  
CONNECTOR HOUSING



TE Part #206070-8  
CABLE CLAMP KIT #17

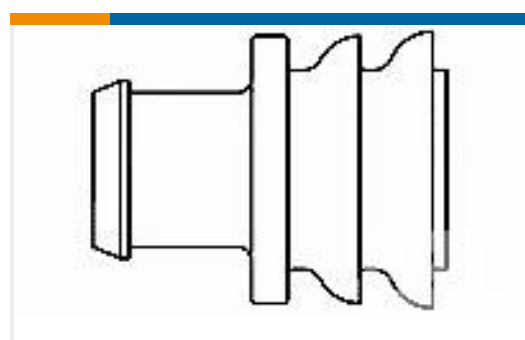

TE Part #281934-2  
SINGLE WIRE SEAL



TE Part #0460-202-16141  
DEUTSCH SOLID CONTACTS

## Documents



## Product Drawings

### LOCKING SLIDE

English

---

## CAD Files

### 3D PDF

English

#### Customer View Model

[ENG\\_CVM\\_926635-2\\_D.2d\\_dxf.zip](#)

English

#### Customer View Model

[ENG\\_CVM\\_926635-2\\_D.3d\\_igs.zip](#)

English

#### Customer View Model

[ENG\\_CVM\\_926635-2\\_D.3d\\_stp.zip](#)

English

By downloading the CAD file I accept and agree to the [Terms and Conditions](#) of use.

---

## Product Specifications

### Product Specification

English