



MATE-N-LOK | Universal MATE-N-LOK

TE Internal #: 927231-3

Rectangular Power Connectors, Housing, Receptacle, Wire-to-Panel / Wire-to-Wire, 9 Position, .25 in [6.35 mm] Centerline, Universal MATE-N-LOK

[View on TE.com >](#)

Connectors > Power Connectors > Rectangular Power > Rectangular Power Connectors

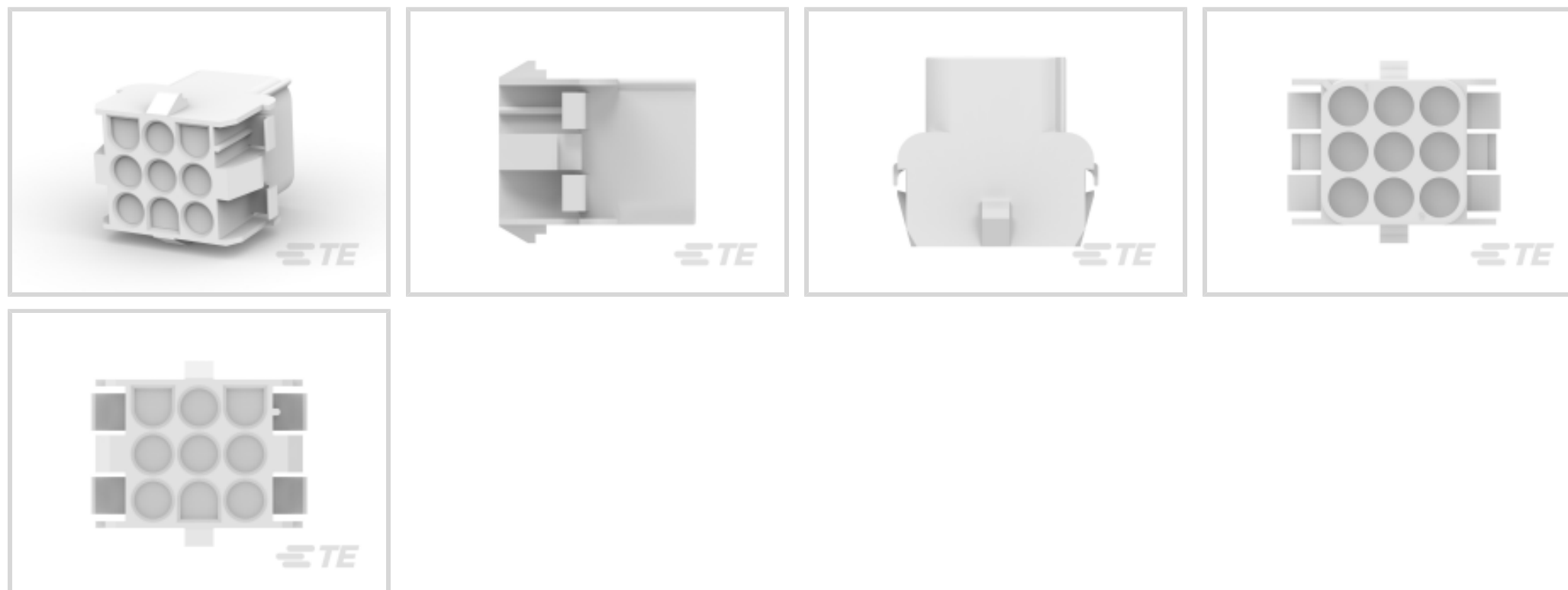

Rectangular Power Connector Type: **Housing**

Connector & Housing Type: **Receptacle**

Connector System: **Wire-to-Panel, Wire-to-Wire**

Number of Positions: **9**

Centerline (Pitch): **6.35 mm [.25 in]**

Features

Product Type Features

Rectangular Power Connector Type	Housing
Connector & Housing Type	Receptacle
Connector System	Wire-to-Panel, Wire-to-Wire
Sealable	No
Connector & Contact Terminates To	Wire & Cable

Configuration Features

Number of Positions	9
Number of Rows	3

Electrical Characteristics

Operating Voltage	600 VAC
-------------------	---------

Contact Features

Contact Layout	Matrix
Multiple Contact Types	Without
Contact Retention Within Housing	Without



Contact Type	Pin
--------------	-----

Termination Features

Termination Method to Wire & Cable	Crimp
------------------------------------	-------

Mechanical Attachment

Panel Mount Feature	With
---------------------	------

Panel Mount Feature Type	Patch & Tabs
--------------------------	--------------

Connector Mounting Type	Panel Mount
-------------------------	-------------

Housing Features

Centerline (Pitch)	6.35 mm [.25 in]
--------------------	------------------

Housing Color	Natural
---------------	---------

Housing Material	PA 66
------------------	-------

Dimensions

Row-to-Row Spacing	6.35 mm [.25 in]
--------------------	------------------

Panel Thickness	.76 – 2.29 mm [.03 – .09 in]
-----------------	------------------------------

Usage Conditions

Operating Temperature Range	-55 – 125 °C [-67 – 257 °F]
-----------------------------	-----------------------------

Operation/Application

Assembly Integration Feature	Without
------------------------------	---------

Circuit Application	Power & Signal
---------------------	----------------

Industry Standards

CSA Rating	Certified
------------	-----------

UL Flammability Rating	UL 94V-0
------------------------	----------

Glow Wire Rating	Standard Part - Not Glow Wire
------------------	-------------------------------

Agency/Standard Number	E28476
------------------------	--------

Agency/Standard	CSA, UL
-----------------	---------

UL Rating	Recognized
-----------	------------

CSA File Number	LR7189
-----------------	--------

VDE Tested	Yes
------------	-----

Packaging Features

Packaging Method	Bag & Box
------------------	-----------

Packaging Quantity	1000
--------------------	------



Other

For Use With	Universal MATE-N-LOK Plug or Socket Housing
--------------	---

Product Compliance

[For compliance documentation, visit the product page on TE.com>](#)

EU RoHS Directive 2011/65/EU	Compliant
EU ELV Directive 2000/53/EC	Compliant
China RoHS 2 Directive MIIT Order No 32, 2016	No Restricted Materials Above Threshold
EU REACH Regulation (EC) No. 1907/2006	Current ECHA Candidate List: JUNE 2022 (224) Candidate List Declared Against: JUNE 2022 (224) Does not contain REACH SVHC
Halogen Content	Low Halogen - Br, Cl, F, I < 900 ppm per homogenous material. Also BFR/CFR/PVC Free
Solder Process Capability	Not applicable for solder process capability

Product Compliance Disclaimer

This information is provided based on reasonable inquiry of our suppliers and represents our current actual knowledge based on the information they provided. This information is subject to change. The part numbers that TE has identified as EU RoHS compliant have a maximum concentration of 0.1% by weight in homogenous materials for lead, hexavalent chromium, mercury, PBB, PBDE, DBP, BBP, DEHP, DIBP, and 0.01% for cadmium, or qualify for an exemption to these limits as defined in the Annexes of Directive 2011/65/EU (RoHS2). Finished electrical and electronic equipment products will be CE marked as required by Directive 2011/65/EU. Components may not be CE marked. Additionally, the part numbers that TE has identified as EU ELV compliant have a maximum concentration of 0.1% by weight in homogenous materials for lead, hexavalent chromium, and mercury, and 0.01% for cadmium, or qualify for an exemption to these limits as defined in the Annexes of Directive 2000/53/EC (ELV). Regarding the REACH Regulation, the information TE provides on SVHC in articles for this part number is based on the latest European Chemicals Agency (ECHA) 'Guidance on requirements for substances in articles' posted at this URL: <https://echa.europa.eu/guidance-documents/guidance-on-reach>

Compatible Parts

 <p>TE Part # 350432-4 09P UMNL PIN HDR ASSY NATL LF</p>	 <p>TE Part # 350828-4 09P UMNL HDR ASSY PC 94VO LF</p>	 <p>TE Part # 350835-1 09P UMNL HDR ASSY PC 94VO</p>	 <p>TE Part # 350586-1 09P UMNL PIN HDR ASSY V2 NATL</p>
---	--	---	---



TE Part # 350990-4
09P UMNL HDR ASSY LNG/TL



TE Part # 350835-4
09P UMNL HDR ASSY PC 94VO LF



TE Part # 350586-4
09P UMNL HDR ASSY PC NATL LF



TE Part # 350712-4
09P UMNL PIN HDR ASSY 94VO LF



TE Part # 350712-1
09P UMNL PIN HDR ASSY 94VO



TE Part # 350742-4
09P UMNL PIN HDR ASSY 94VO LF



TE Part # 641971-1
09P UMNL PIN HDR ASSY V2 NATL



TE Part # 643426-3
09P UMNL SOK HDR ASSY POL LF



TE Part # 641972-3
09P UMNL PIN HDR ASSY 94VO LF



TE Part # 350720-1
09P UMNL PLUG HSG



TE Part # 350828-1
09P UMNL HDR ASSY PC 94VO



TE Part # 350763-4
09P UMNL HDR ASSY PC



TE Part # 770039-1
09P UMNL II PLUG-FRONT 94VO



TE Part # 350432-1
09P UMNL PIN HDR ASSY NATL



TE Part # 770021-1
09P UMNLII IN-LNE PLUG HSG KIT



TE Part # 770040-1
09P UMNL II PLUG REAR 94VO

Also in the Series | **Universal MATE-N-LOK**



Circular Power Connectors(2)



Connector Contacts(11)



Insertion & Extraction Tools(4)

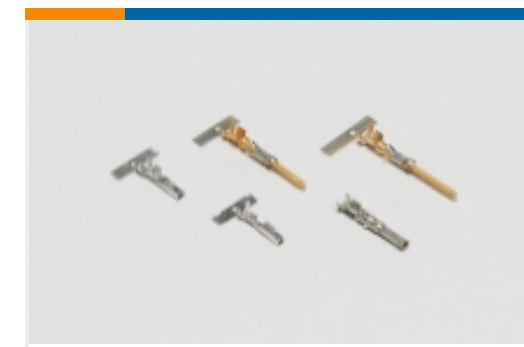

Power Contacts(207)



Rectangular Boots & Strain Relief(35)

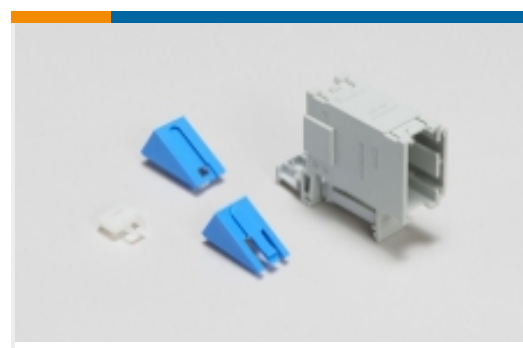

Rectangular Connector Adapters(7)

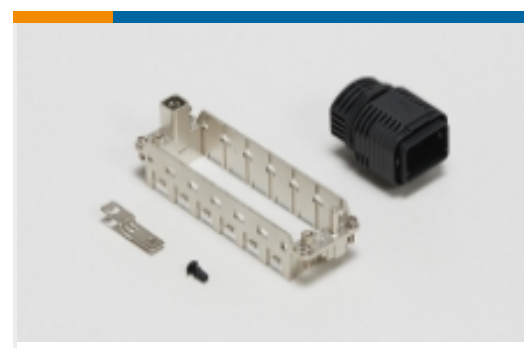

Rectangular Connector Hardware(1)



Rectangular Connector Housings(2)



Rectangular Connector Keying Plugs(3)



Rectangular Connector Locking(4)



Rectangular Connector Seals(26)



Rectangular Power Connectors(729)

Customers Also Bought



TE Part #926307-3
6P UN-MNL AUFN-GEH



TE Part #926301-3
8P UN-MNL STECKGEH



TE Part #926647-3
UNIV.M-N-L.CAP HSG



TE Part #350720-1
09P UMNL PLUG HSG



TE Part #350715-4
06P UMNL PLUG HSG UL94VO



TE Part #350735-4
12P UMNL PLUG HSG UL94VO



TE Part #926895-3
UNIVERSAL M-N-L SOCKET

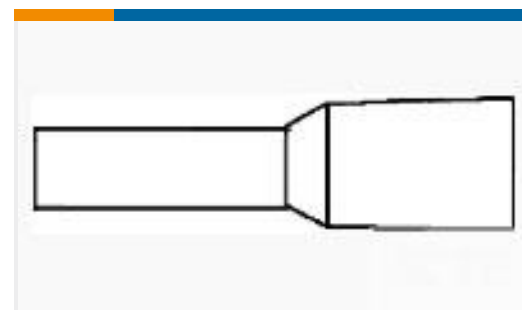

TE Part #966144-3
DOPPLEIT ADERENDH L

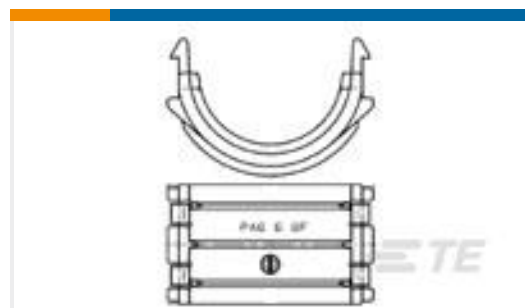

TE Part #964732-1
BEFESTIGUNGSSCHALE



TE Part #T4113012041-000
M12 M, 4P GOLD A_CODE RA SHIELDED PG9

Documents



Product Drawings

HONHUS UMNL V0 9-P

English

CAD Files

3D PDF

3D

Customer View Model

[ENG_CVM_CVM_927231-3_E.2d_dxf.zip](#)

English

Customer View Model

[ENG_CVM_CVM_927231-3_E.3d_igs.zip](#)

English

Customer View Model

[ENG_CVM_CVM_927231-3_E.3d_stp.zip](#)

English

By downloading the CAD file I accept and agree to the [Terms and Conditions](#) of use.

Product Specifications

Universal MATE-N-LOK Connector

English

Product Environmental Compliance

Product Compliance

English

Product Compliance

English

Agency Approvals

CSA Certificate

English