



AMP | Timer Connector System

TE Internal #: 962884-2

Automotive Terminals, Tab, Mating Tab Width 2.8 mm [.11 in], Tab Thickness .031 in [.8 mm], 17 – 13 AWG Wire Size, Timer Connector System

[View on TE.com >](#)

Terminals & Splices > Automotive Terminals > TIMER, RECEPTACLE AND TAB

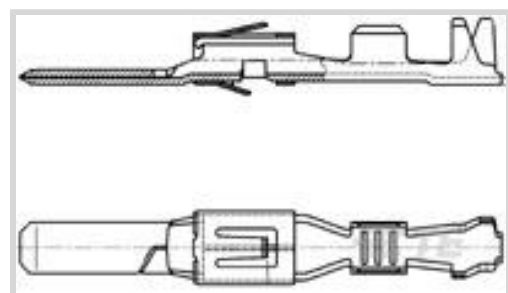

Terminal Type: **Tab**

Mating Tab Width: **2.8 mm [.11 in]**

Mating Tab Thickness: **.8 mm [.031 in]**

Terminal Transmits: **25 – 40 A (Power)**

Wire Size: **17 – 13 AWG**

[All TIMER, RECEPTACLE AND TAB \(344\)](#)

Features

Product Type Features

Sealable	No
Primary Locking Feature	Locking Lance

Contact Features

Contact Size	2.8mm
Contact Fabrication	Stamped & Formed
Typical Current Rating	30 A
Crimp Type	F-Crimp
Terminal Type	Tab
Mating Tab Width	2.8 mm [.11 in]
Mating Tab Thickness	.8 mm [.031 in]
Interface Plating	Tin (Sn)
Contact Termination Area Plating Material	Tin (Sn)

Termination Features

Termination Method to Wire & Cable	Crimp
Product Terminates To	Wire

Dimensions

Wire Size	1 – 2.5 mm ²
-----------	-------------------------



Wire Size Search	13 AWG, 14 AWG, 15 AWG, 16 AWG, 17 AWG
------------------	--

Wire Insulation Diameter	2.2 – 2.4 mm [.08 – .114 in]
--------------------------	------------------------------

Usage Conditions

Insulation Option	Uninsulated
-------------------	-------------

Operating Temperature (Max)	80 °C, 85 °C, 90 °C, 100 °C, 105 °C, 110 °C, 120 °C, 125 °C, 130 °C [176 °F][185 °F][194 °F][212 °F][221 °F][230 °F][248 °F][257 °F][266 °F]
-----------------------------	--

Operating Temperature Range	-40 – 130 °C [-40 – 266 °F]
-----------------------------	-----------------------------

Operation/Application

Compatible With Wire Base Material	Copper
------------------------------------	--------

Packaging Features

Packaging Method	Reel
------------------	------

Packaging Quantity	3500
--------------------	------

Other

Terminal Transmits	25 – 40 A (Power)
--------------------	-------------------

Product Compliance

[For compliance documentation, visit the product page on TE.com>](#)

EU RoHS Directive 2011/65/EU	Compliant
------------------------------	-----------

EU ELV Directive 2000/53/EC	Compliant
-----------------------------	-----------

China RoHS 2 Directive MIIT Order No 32, 2016	No Restricted Materials Above Threshold
---	---

EU REACH Regulation (EC) No. 1907/2006	Current ECHA Candidate List: JUNE 2022 (224) Candidate List Declared Against: JUNE 2022 (224) Does not contain REACH SVHC
--	---

Halogen Content	Low Halogen - Br, Cl, F, I < 900 ppm per homogenous material. Also BFR/CFR/PVC Free
-----------------	---

Solder Process Capability	Not applicable for solder process capability
---------------------------	--

Product Compliance Disclaimer

This information is provided based on reasonable inquiry of our suppliers and represents our current actual knowledge based on the information they provided. This information is subject to change. The part numbers that TE has identified as EU RoHS compliant have a maximum concentration of 0.1% by weight in homogenous materials for lead, hexavalent chromium, mercury, PBB, PBDE, DBP, BBP, DEHP, DIBP, and 0.01% for cadmium, or qualify for an exemption to these

limits as defined in the Annexes of Directive 2011/65/EU (RoHS2). Finished electrical and electronic equipment products will be CE marked as required by Directive 2011/65/EU. Components may not be CE marked. Additionally, the part numbers that TE has identified as EU ELV compliant have a maximum concentration of 0.1% by weight in homogenous materials for lead, hexavalent chromium, and mercury, and 0.01% for cadmium, or qualify for an exemption to these limits as defined in the Annexes of Directive 2000/53/EC (ELV). Regarding the REACH Regulation, the information TE provides on SVHC in articles for this part number is based on the latest European Chemicals Agency (ECHA) 'Guidance on requirements for substances in articles' posted at this URL: <https://echa.europa.eu/guidance-documents/guidance-on-reach>

Compatible Parts



TE Part # CAT-T4827-CH8172
TIMER, CONNECTOR HOUSING



TE Part # 2305570-1
TERMINAL CUTTER, SIDE FEED



TE Part # 2-1579007-5
EXTRACTION TOOL



TE Part # 2-2151562-2
OCEAN_2.0_Applicator-S-110F1400



TE Part # 2151562-2
OCEAN_2.0_Applicator-S-110F1400



TE Part # 7-2151562-2
OCEAN_2.0_Applicator-S-110F1400



TE Part # 7-2151562-7
OCEAN_2.0_SPARE_PART_KIT-110F1400

Also in the Series | Timer Connector System



Automotive Connector Caps & Covers (11)

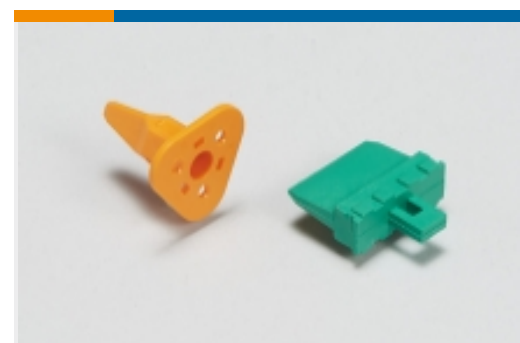

Automotive Connector Locks & Position Assurance(16)



Automotive Housings(219)



Automotive Seals & Cavity Plugs(31)

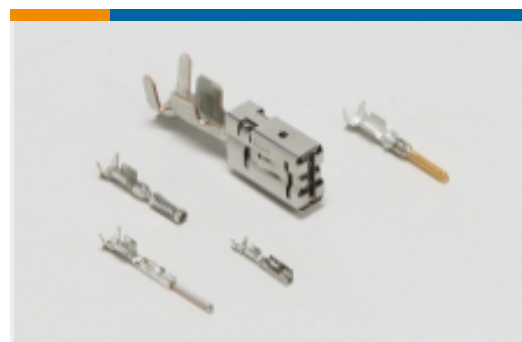

Automotive Terminals(138)



Crimp Terminal Housings(13)



Insertion & Extraction Tools(20)



Other Automotive Connector Accessories(1)

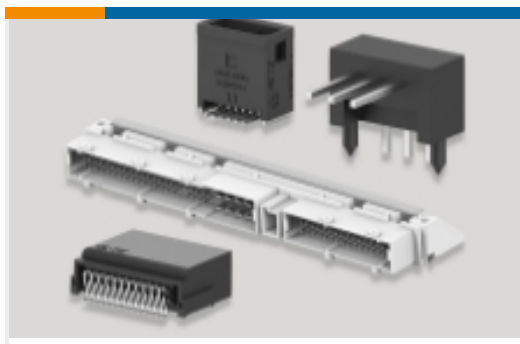

PCB Headers & Receptacles(78)

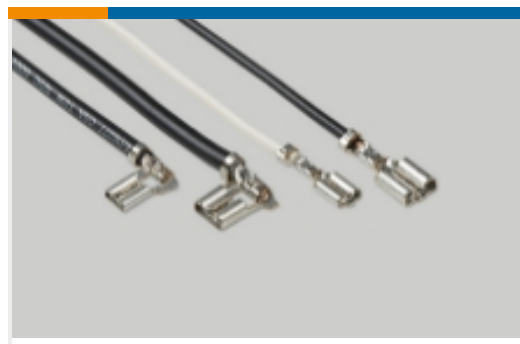

Quick Disconnects(4)

Customers Also Bought



TE Part #1-2112162-1
21POS,TAB 2.8X0.8,TAB HSG,SEALED ASSY



TE Part #42460-1
FF 250 TAB 18-14AWG BR

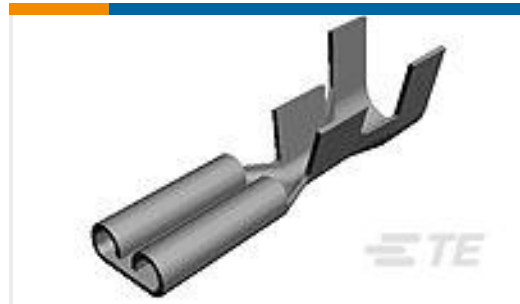

TE Part #5-160431-2
187 FASTON REC 16-14 AWG TPBR



TE Part #180453-1
FF 312 REC 1-2.5MM2 BR



TE Part #DRB16-128SAE-L018
PLG, 128P, BLK, E, CAP, A

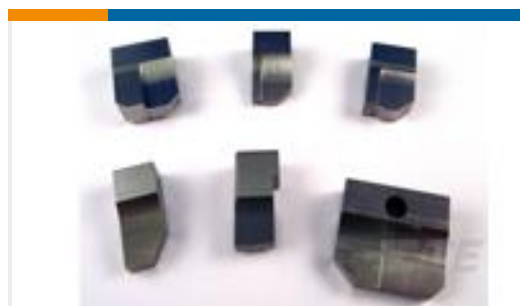

TE Part #1338686-3
ANVIL

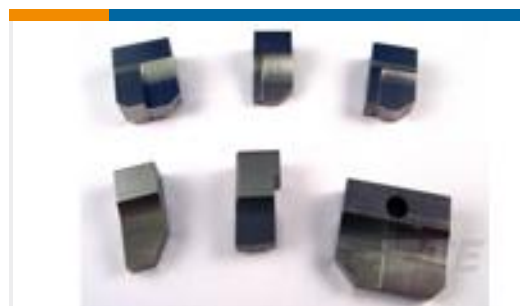

TE Part #1-879333-1
AMBOSS



TE Part #3-547874-4
NONRETURN VALVE, AS1201F-M5-06K

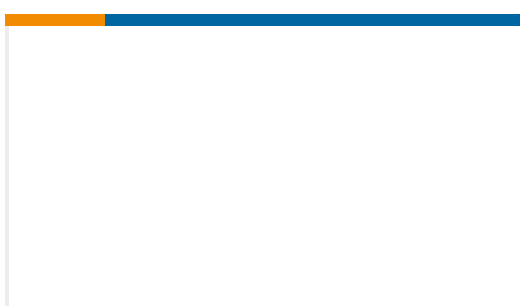

TE Part #5-509910-5
PRESSURE REGULATING VALVE

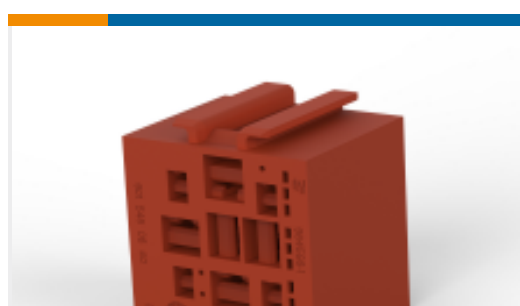

TE Part #9-964598-1
HALTER F.9P RELAIS

Documents

Product Drawings

TAB AS 2.8x0.8 CONTACT CF SRC Sn

English

CAD Files

Customer View Model

ENG_CVM_962884-2_G.3d_igs.zip

English

Customer View Model



[ENG_CVM_962884-2_G.3d_stp.zip](#)

English

Customer View Model

[ENG_CVM_962884-2_G.2d_dxf.zip](#)

English

3D PDF

English

By downloading the CAD file I accept and agree to the [Terms and Conditions](#) of use.

Datasheets & Catalog Pages

Timer Interconnection System

English

Product Specifications

Application Specification

German

Application Specification

English