



AMP | Round Connector System

TE Internal #: 962972-1

Automotive Terminals, Pin, Pin Diameter .098 in [2.5 mm], 17 – 13 AWG Wire Size, 1 – 2.5 mm<sup>2</sup> Wire Size, Sealable, Round Connector System

[View on TE.com >](#)

Terminals & Splices > Automotive Terminals > ROUND CONNECTOR SYSTEM, PIN AND SOCKET

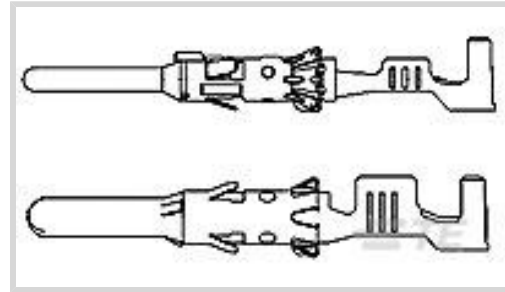

Terminal Type: Pin

Mating Pin Diameter: 2.5 mm [.098 in]

Terminal Transmits: 25 – 40 A (Power)

Wire Size: 1 – 2.5 mm<sup>2</sup>

[All Round Connector System, Pin and Socket \(74\)](#)

Features

Product Type Features

Receptacle Style	180°
Sealable	Yes
Primary Locking Feature	Locking Lance

Body Features

Terminal Seal Type	Single Wire Seal (SWS)
--------------------	------------------------

Contact Features

Contact Size	2.5mm
Contact Fabrication	Stamped & Formed
Crimp Type	F-Crimp
Terminal Type	Pin
Mating Pin Diameter	2.5 mm[.098 in]
Interface Plating	Tin (Sn)
Contact Termination Area Plating Material	Tin (Sn)

Termination Features

Termination Method to Wire & Cable	Crimp
Product Terminates To	Wire

Dimensions

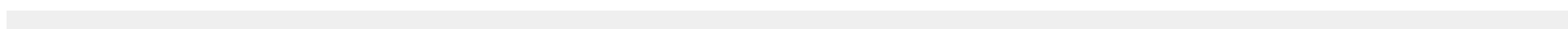



Wire Size	1 – 2.5 mm <sup>2</sup>
Wire Size Search	13 AWG, 14 AWG, 15 AWG, 16 AWG, 17 AWG
Wire Insulation Diameter	2.2 – 3 mm [.086 – .118 in]

### Usage Conditions

Insulation Option	Uninsulated
Operating Temperature (Max)	80 °C, 85 °C, 90 °C, 100 °C, 105 °C, 110 °C, 120 °C, 125 °C, 130 °C [176 °F][185 °F][194 °F][212 °F][221 °F][230 °F][248 °F][257 °F][266 °F]
Operating Temperature Range	-40 – 130 °C [-40 – 266 °F]

### Operation/Application

Compatible With Wire Base Material	Copper
------------------------------------	--------

### Industry Standards

Agency/Standard	AK
-----------------	----

### Packaging Features

Packaging Method	Box
Packaging Quantity	500

### Other

Terminal Transmits	25 – 40 A (Power)
--------------------	-------------------

## Product Compliance

[For compliance documentation, visit the product page on TE.com>](#)

EU RoHS Directive 2011/65/EU	Compliant
EU ELV Directive 2000/53/EC	Compliant
China RoHS 2 Directive MIIT Order No 32, 2016	No Restricted Materials Above Threshold
EU REACH Regulation (EC) No. 1907/2006	Current ECHA Candidate List: JUNE 2022 (224) Candidate List Declared Against: JUNE 2022 (224) Does not contain REACH SVHC
Halogen Content	Low Halogen - Br, Cl, F, I < 900 ppm per homogenous material. Also BFR/CFR/PVC Free
Solder Process Capability	Not applicable for solder process capability

Product Compliance Disclaimer

This information is provided based on reasonable inquiry of our suppliers and represents our current actual knowledge based on the information they provided. This information is subject to change. The part numbers that TE has identified as EU RoHS compliant have a maximum concentration of 0.1% by weight in homogenous materials for lead, hexavalent chromium, mercury, PBB, PBDE, DBP, BBP, DEHP, DIBP, and 0.01% for cadmium, or qualify for an exemption to these limits as defined in the Annexes of Directive 2011/65/EU (RoHS2). Finished electrical and electronic equipment products will be CE marked as required by Directive 2011/65/EU. Components may not be CE marked. Additionally, the part numbers that TE has identified as EU ELV compliant have a maximum concentration of 0.1% by weight in homogenous materials for lead, hexavalent chromium, and mercury, and 0.01% for cadmium, or qualify for an exemption to these limits as defined in the Annexes of Directive 2000/53/EC (ELV). Regarding the REACH Regulation, the information TE provides on SVHC in articles for this part number is based on the latest European Chemicals Agency (ECHA) 'Guidance on requirements for substances in articles' posted at this URL: <https://echa.europa.eu/guidance-documents/guidance-on-reach>

## Compatible Parts



TE Part # 58606-1  
PROCrimp 1.5 & 2.5MM PIN/SEAL



TE Part # 1-1579007-8  
EXTRACTION TOOL



TE Part # 3-1579007-2  
INSERTION TOOL



TE Part # 2063561-1  
SDE P&S ROUND 12-14AWG ASSY



TE Part # 2063561-2  
SDE P&S ROUND 12-14AWG DIE SET



TE Part # 58606-2  
PC DIE 1.5 & 2.5 PIN W/S



TE Part # 539679-2  
MATRIZE 2,5 MM D



TE Part # 1579024-5  
HT33-SDE HAND TOOL 1.5, 2.5 DIA. CONTACT

## Also in the Series | Round Connector System



Automotive Connector Caps & Covers (5)



Automotive Housings(16)



Automotive Seals & Cavity Plugs(3)

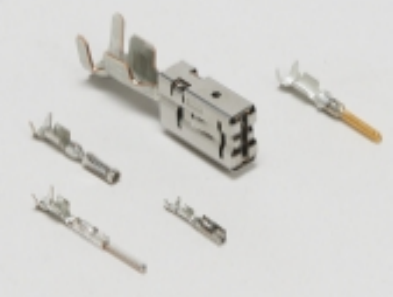

Automotive Terminals(74)



Insertion & Extraction Tools(8)

## Customers Also Bought



TE Part #962938-1  
MPT REC 9.5 Contact SWS Sn



TE Part #1-968968-1  
2,5MM BU-GEH ASSY4P

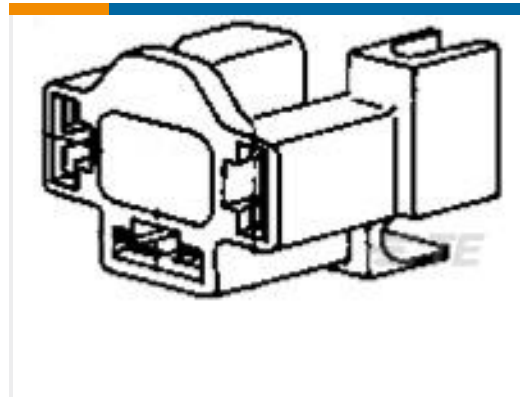

TE Part #925176-5  
FF 312 3P HOUSING REC POLYAMID  
6.6 BLACK



TE Part #5-963729-1  
MQS SOCKET CONTACT



TE Part #927882-8  
POS LOCK RECEPTACLE 6,3



TE Part #925068  
250 FASTON HSG. REC. 1P CLEAR



TE Part #963728-1  
MQS PIN CONTACT SWS



TE Part #962999-1  
1,5MMD SOCKET CONTACT

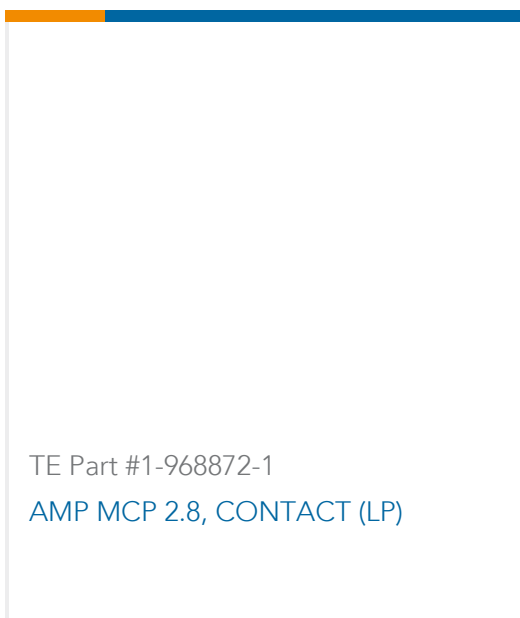

TE Part #1-968872-1  
AMP MCP 2.8, CONTACT (LP)

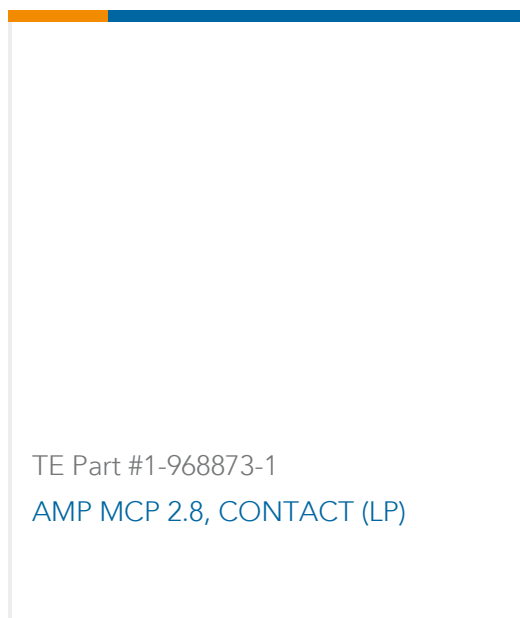

TE Part #1-968873-1  
AMP MCP 2.8, CONTACT (LP)

## Documents

### Product Drawings

[2,5MMD PIN CONTACT](#)

English

### CAD Files

Customer View Model

[ENG\\_CVM\\_962972-1\\_A2.3d\\_igs.zip](#)

English

Customer View Model



[ENG\\_CVM\\_962972-1\\_A2.3d\\_stp.zip](#)

English

**Customer View Model**

[ENG\\_CVM\\_962972-1\\_A2.2d\\_dxf.zip](#)

English

**3D PDF**

English

By downloading the CAD file I accept and agree to the [Terms and Conditions](#) of use.

---

### Datasheets & Catalog Pages

**CONNECTOR SELECTOR**

English

---

### Product Environmental Compliance

**Product Compliance**

English

**Product Compliance**

English