

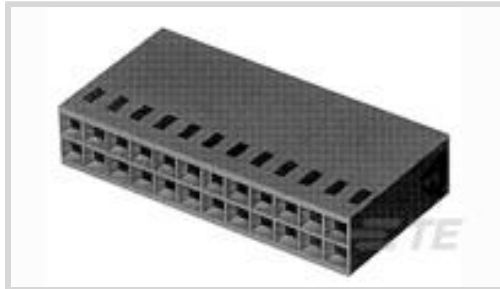

Connectors > PCB Connectors > Wire-to-Board Connectors > Wire-to-Board Connector Assemblies & Housings



Connector Product Type: **Housing**  
Connector & Housing Type: **Receptacle**  
Connector System: **Wire-to-Board**  
Number of Positions: **14**  
Centerline (Pitch): **2.54 mm [.1 in]**

### Features

#### Product Type Features

Connector Product Type	Housing
Connector & Housing Type	Receptacle
Connector System	Wire-to-Board
Connector & Contact Terminates To	Wire & Cable

#### Configuration Features

Number of Positions	14
Number of Rows	2

#### Electrical Characteristics

Operating Voltage	250 VAC
-------------------	---------

#### Contact Features

Contact Type	Socket
Contact Current Rating (Max)	3 A

#### Termination Features

Termination Method to Wire & Cable	Crimp
------------------------------------	-------

#### Mechanical Attachment

Strain Relief	Without
Mating Retention	Without
Connector Mounting Type	Cable Mount (Free-Hanging)



### Housing Features

Housing Entry Configuration	Both Ends Closed
Housing Material	PA 6.6
Centerline (Pitch)	2.54 mm [.1 in]
Housing Color	Green

### Dimensions

	.55 in
Row-to-Row Spacing	2.54 mm [.1 in]

### Usage Conditions

Operating Temperature Range	-65 – 105 °C [-85 – 221 °F]
-----------------------------	-----------------------------

### Operation/Application

Circuit Application	Signal
---------------------	--------

### Industry Standards

Glow Wire Rating	Standard Part - Not Glow Wire
UL Flammability Rating	UL 94V-0

### Packaging Features

Packaging Quantity	1000
Packaging Method	Carton

### Product Compliance

[For compliance documentation, visit the product page on TE.com>](#)

EU RoHS Directive 2011/65/EU	Compliant
EU ELV Directive 2000/53/EC	Compliant
China RoHS 2 Directive MIIT Order No 32, 2016	No Restricted Materials Above Threshold
EU REACH Regulation (EC) No. 1907/2006	Current ECHA Candidate List: JUNE 2022 (224) Candidate List Declared Against: JAN 2022 (223) SVHC > Threshold: Not Yet Reviewed
Halogen Content	BFR/CFR/PVC Free, but Br/Cl >900 ppm in other sources.
Solder Process Capability	Not applicable for solder process capability



Product Compliance Disclaimer

This information is provided based on reasonable inquiry of our suppliers and represents our current actual knowledge based on the information they provided. This information is subject to change. The part numbers that TE has identified as EU RoHS compliant have a maximum concentration of 0.1% by weight in homogenous materials for lead, hexavalent chromium, mercury, PBB, PBDE, DBP, BBP, DEHP, DIBP, and 0.01% for cadmium, or qualify for an exemption to these limits as defined in the Annexes of Directive 2011/65/EU (RoHS2). Finished electrical and electronic equipment products will be CE marked as required by Directive 2011/65/EU. Components may not be CE marked. Additionally, the part numbers that TE has identified as EU ELV compliant have a maximum concentration of 0.1% by weight in homogenous materials for lead, hexavalent chromium, and mercury, and 0.01% for cadmium, or qualify for an exemption to these limits as defined in the Annexes of Directive 2000/53/EC (ELV). Regarding the REACH Regulation, the information TE provides on SVHC in articles for this part number is based on the latest European Chemicals Agency (ECHA) 'Guidance on requirements for substances in articles' posted at this URL: <https://echa.europa.eu/guidance-documents/guidance-on-reach>

### Compatible Parts

TE Part # 826632-7  
7P AMPMODU II PIN HDR.

TE Part # 1-141708-1  
MOD IV RECEPTACLE, CRIMP SNAP IN, LP

TE Part # 926519-2  
KEYING PLUG

TE Part # 141708-1  
MOD-4 REC.CONT.SCP.

TE Part # 167021-2  
MOD-4 REC.CONT.SCP.

TE Part # 167301-4  
MOD-4 REC.CONT.SCP

TE Part # 2-167301-4  
MOD-4 REC.CONT.SCP

TE Part # 2-167301-2  
MOD-4 REC.CONT.SCP

TE Part # 167024-1  
MOD-4 REC.CONT.SCP.

TE Part # 826634-7  
07P MODU 2 PIN HDR.

TE Part # 826942-7  
7P MOD2 STIFT LEI

TE Part # 1241050-7  
2x7P MOD II BREAK AWAY HDR,SMD, BLISTER

TE Part # 167023-1  
MOD-4 REC.CONTACT

TE Part # 166310-2  
MOD-5 REC.CONTACT

TE Part # 167300-6  
MOD-4 REC.CONTACT

TE Part # 167300-8  
MOD-4 REC.CONTACT

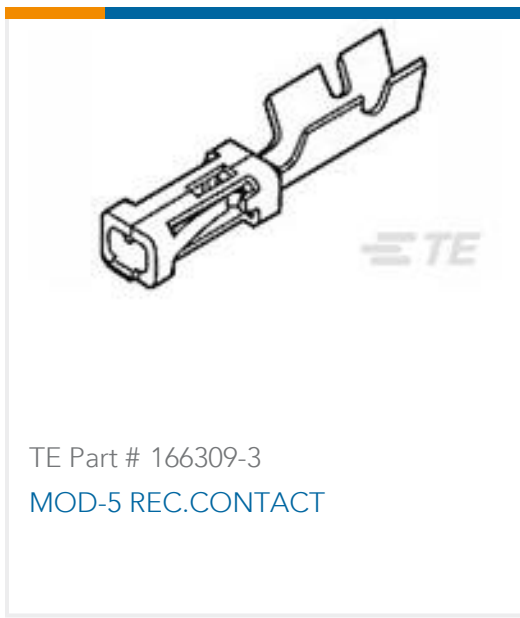

## Also in the Series | AMPMODU IV/V

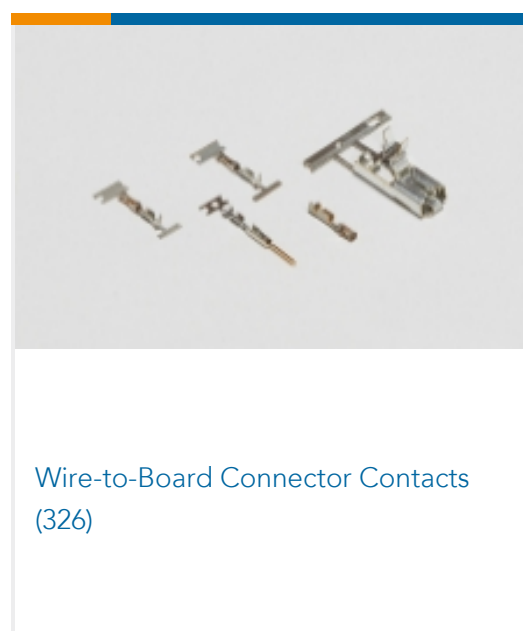
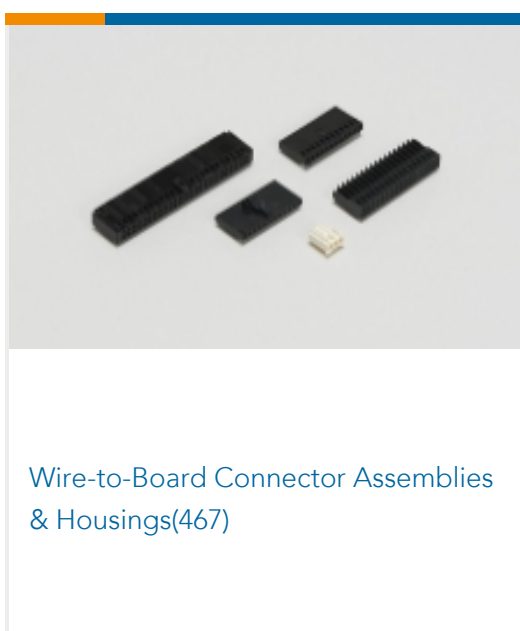
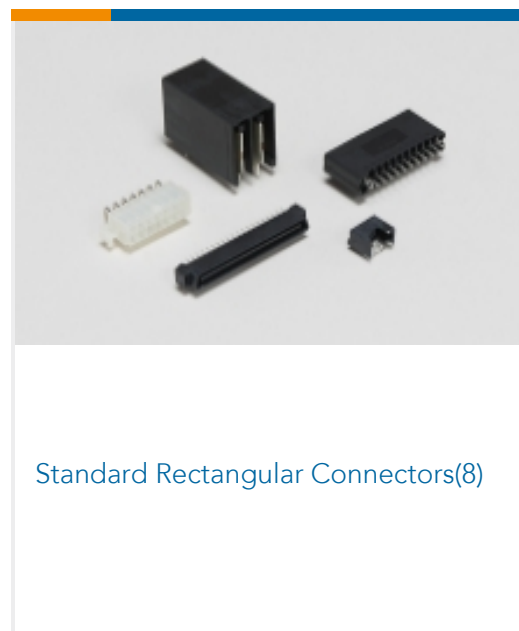
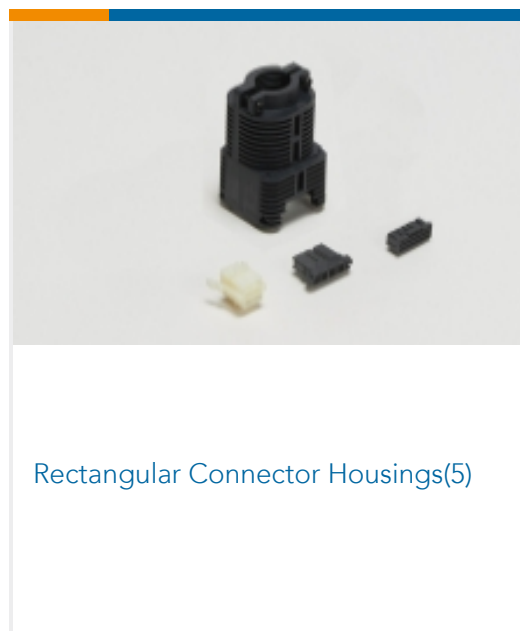
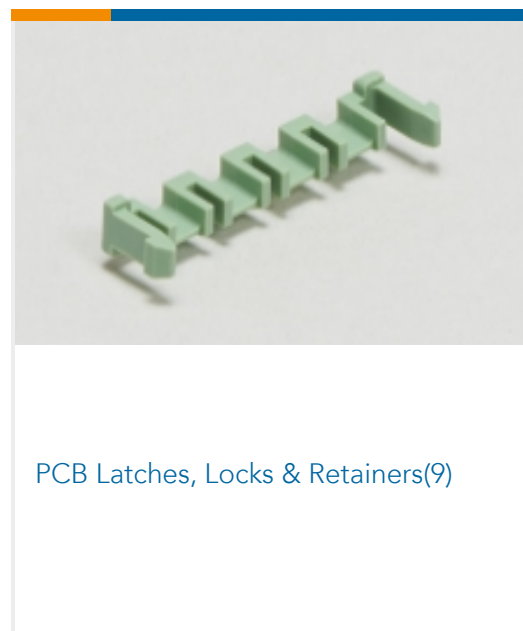
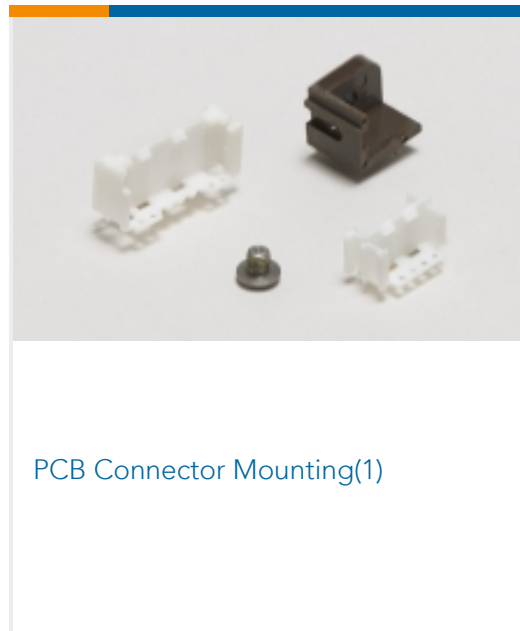
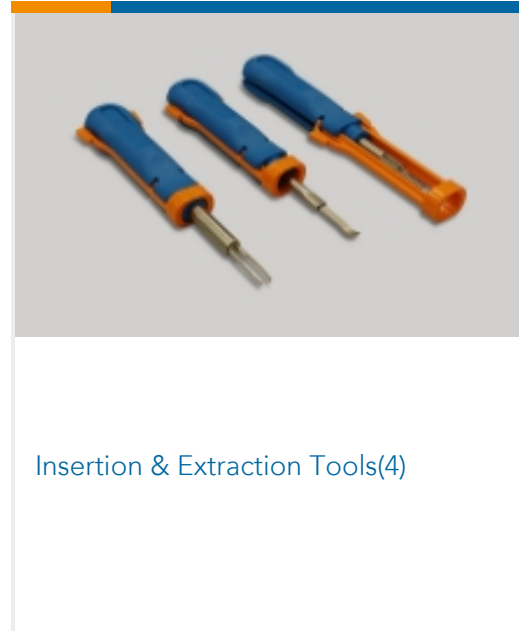
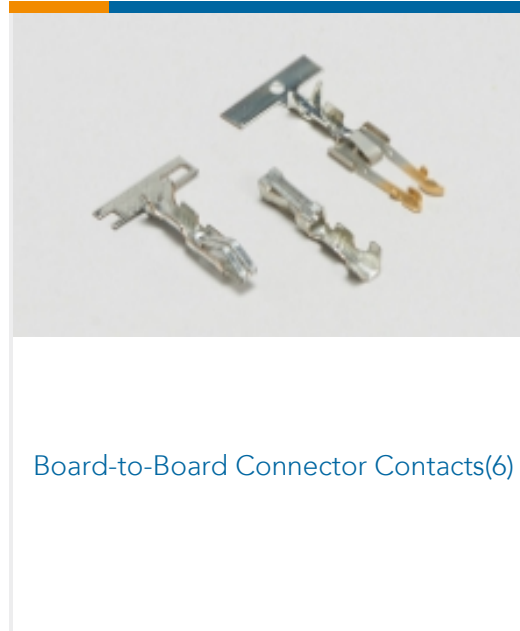
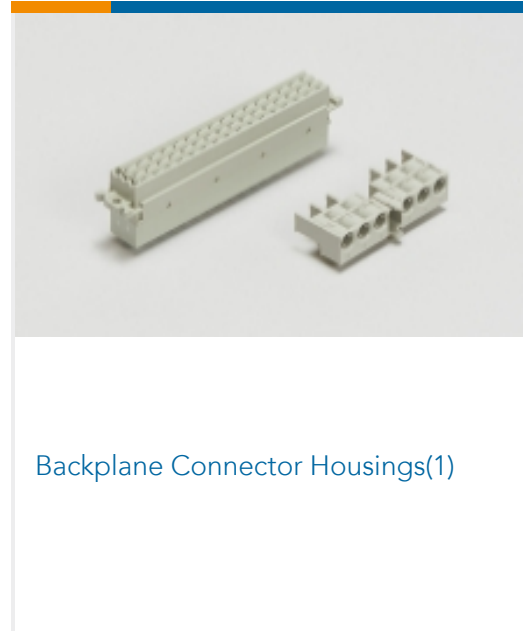
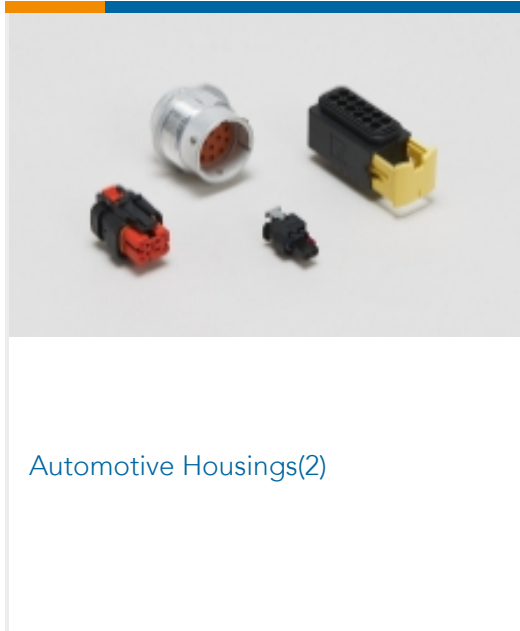

## Customers Also Bought



TE Part #925367-4  
MOD 4 REC.HSG 2X04P

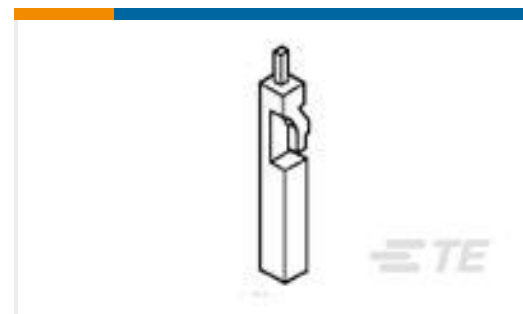

TE Part #926519-2  
KEYING PLUG



TE Part #828921-1  
EINZELADERDICHUNG



TE Part #2-1879021-5  
SMW3 1R0 5%

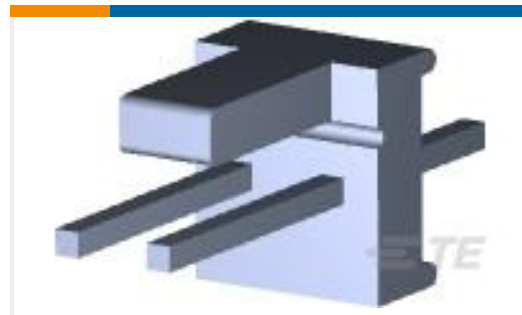

TE Part #640454-2  
02P MTA100 HDR ASSY SQ STR POL

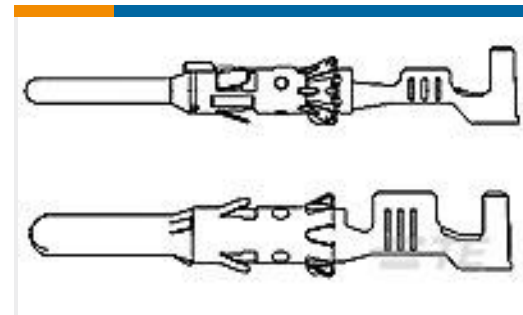

TE Part #929968-1  
2,5MM PIN CONTACT



TE Part #A41385-000  
S02-03-W1-22-9-100



TE Part #CTJ716E01D-6181  
MODULE ASSY

## Documents

### Product Drawings

#### MOD 4 REC.HSG 2X07P

English

### CAD Files

#### 3D PDF

3D

#### Customer View Model

[ENG\\_CVM\\_CVM\\_925367-7\\_AA.2d\\_dxf.zip](#)

English

#### Customer View Model

[ENG\\_CVM\\_CVM\\_925367-7\\_AA.3d\\_igs.zip](#)

English

#### Customer View Model

[ENG\\_CVM\\_CVM\\_925367-7\\_AA.3d\\_stp.zip](#)

English

By downloading the CAD file I accept and agree to the [Terms and Conditions](#) of use.

### Product Specifications

#### Application Specification

English

### Agency Approvals

#### UL Report

English