



Connectors > Power Connectors > Power Contacts



Power Contact Type: **Contact**

Operating Voltage: **250 VAC**

Contact Mating Area Plating Material: **Pre-Tin**

Wire Size: **2.1 – 5.3 mm²**

Features

Product Type Features

Power Contact Type	Contact
Connector System	Wire-to-Wire
Connector & Contact Terminates To	Wire & Cable

Electrical Characteristics

Operating Voltage	250 VAC
-------------------	---------

Contact Features

Contact Mating Area Plating Material	Pre-Tin
Contact Current Rating (Max)	17 A
Contact Type	Pin
Contact Retention Within Housing	With
Mating Pin Diameter	3.56 mm[.14 in]
Contact Base Material	Phosphor Bronze
Wire Contact Termination Area Plating Thickness	1 – 3 μm[39.37 – 118.11 μin]
Wire Contact Termination Area Plating Material	Pre-Tin
Wire Contact Termination Area Plating Material Finish	Bright



Contact Orientation	Straight
---------------------	----------

Termination Features

Termination Method to Wire & Cable	Crimp
------------------------------------	-------

Mechanical Attachment

Contact Retention Type Within Housing	Locking Lance
---------------------------------------	---------------

Connector Mounting Type	Cable Mount (Free-Hanging)
-------------------------	----------------------------

Wire Insulation Support	With
-------------------------	------

Dimensions

Wire Size	2.1 – 5.3 mm ²
-----------	---------------------------

Accepts Wire Insulation Diameter Range	2.5 – 4.5 mm [.098 – .177 in]
--	-------------------------------

Usage Conditions

Operating Temperature Range	-55 – 105 °C [-67 – 221 °F]
-----------------------------	-----------------------------

Operation/Application

Circuit Application	Power
---------------------	-------

Industry Standards

Glow Wire Rating	Standard Part - Not Glow Wire
------------------	-------------------------------

Packaging Features

Packaging Method	Carton
------------------	--------

Packaging Quantity	2500
--------------------	------

Other

Wire/Cable Type	Discrete Wire
-----------------	---------------

Product Compliance

[For compliance documentation, visit the product page on TE.com>](#)

EU RoHS Directive 2011/65/EU	Compliant
------------------------------	-----------

EU ELV Directive 2000/53/EC	Compliant
-----------------------------	-----------

China RoHS 2 Directive MIIT Order No 32, 2016	No Restricted Materials Above Threshold
---	---

EU REACH Regulation (EC) No. 1907/2006	Current ECHA Candidate List: JUNE 2022 (224) Candidate List Declared Against: JAN 2022 (223) SVHC > Threshold: Not Yet Reviewed
--	--



Halogen Content	Low Halogen - Br, Cl, F, I < 900 ppm per homogenous material. Also BFR/CFR/PVC Free
Solder Process Capability	Not applicable for solder process capability

Product Compliance Disclaimer

This information is provided based on reasonable inquiry of our suppliers and represents our current actual knowledge based on the information they provided. This information is subject to change. The part numbers that TE has identified as EU RoHS compliant have a maximum concentration of 0.1% by weight in homogenous materials for lead, hexavalent chromium, mercury, PBB, PBDE, DBP, BBP, DEHP, DIBP, and 0.01% for cadmium, or qualify for an exemption to these limits as defined in the Annexes of Directive 2011/65/EU (RoHS2). Finished electrical and electronic equipment products will be CE marked as required by Directive 2011/65/EU. Components may not be CE marked. Additionally, the part numbers that TE has identified as EU ELV compliant have a maximum concentration of 0.1% by weight in homogenous materials for lead, hexavalent chromium, and mercury, and 0.01% for cadmium, or qualify for an exemption to these limits as defined in the Annexes of Directive 2000/53/EC (ELV). Regarding the REACH Regulation, the information TE provides on SVHC in articles for this part number is based on the latest European Chemicals Agency (ECHA) 'Guidance on requirements for substances in articles' posted at this URL: <https://echa.europa.eu/guidance-documents/guidance-on-reach>

Compatible Parts

 TE Part # 1-480586-0 09P .140 MNL CAP NAT	 TE Part # 1-350347-0 03P .140 MNL CAP PM NAT	 TE Part # 880125 9 CIR CAP 140DIA PANEL MT NAT	 TE Part # 1-480673-0 09P .140 MNL CAP PM NAT
 TE Part # 1-350345-0 02P .140 MNL CAP P/M NAT	 TE Part # 1-480512-0 04P .140 MNL CAP NAT	 TE Part # 794683-1 09P .140 MNL CAP BLK HT	 TE Part # 539764-1 EXTRACTION TOOL
 TE Part # 925450-1 M-N-L PIN HSG	 TE Part # 2-2151321-1 OCEAN_2.0_APPLICATOR-S-140F190O180F	 TE Part # 2-2151321-2 OCEAN_2.0_APPLICATOR-S-140F190O180FA	 TE Part # 2151321-1 OCEAN_2.0_APPLICATOR-S-140F190O180F



Also in the Series | 0.140 MATE-N-LOK

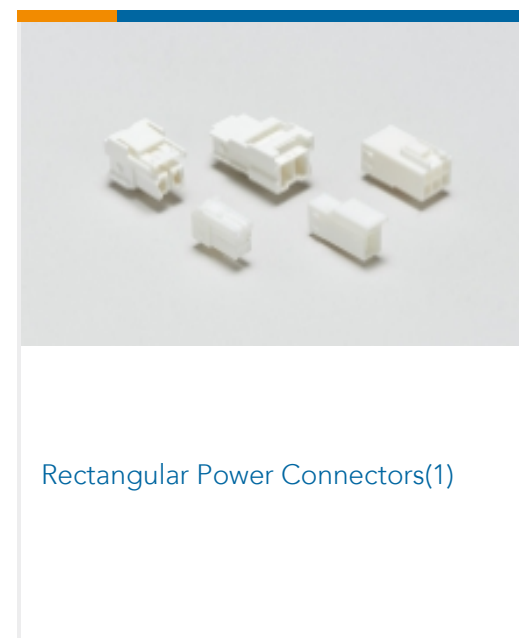
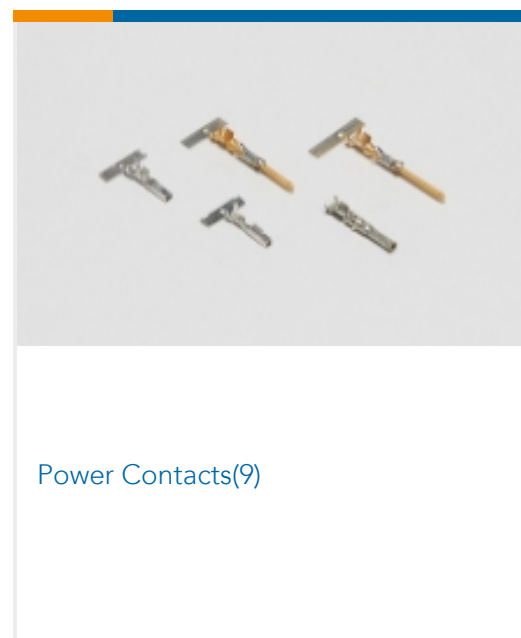
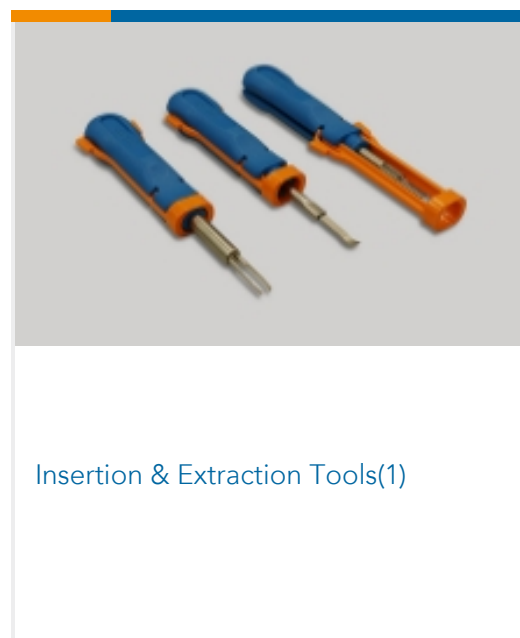
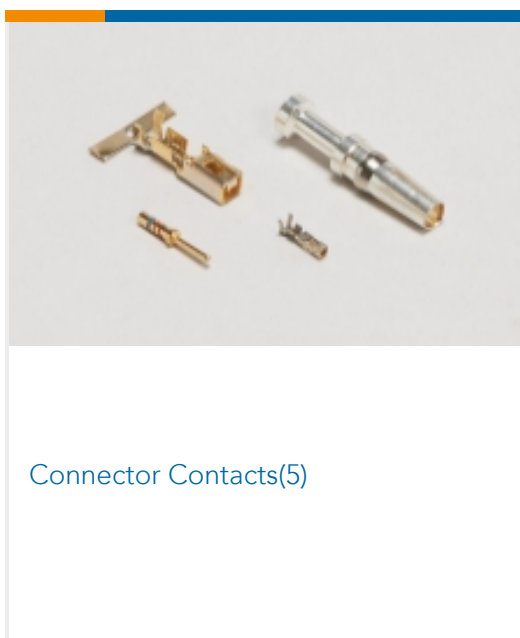

Customers Also Bought

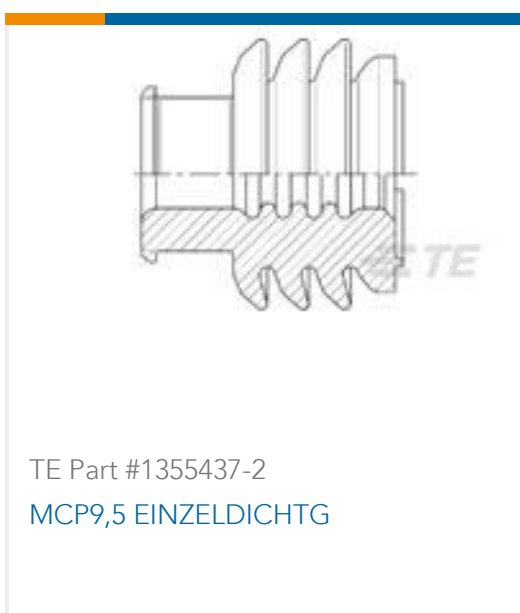
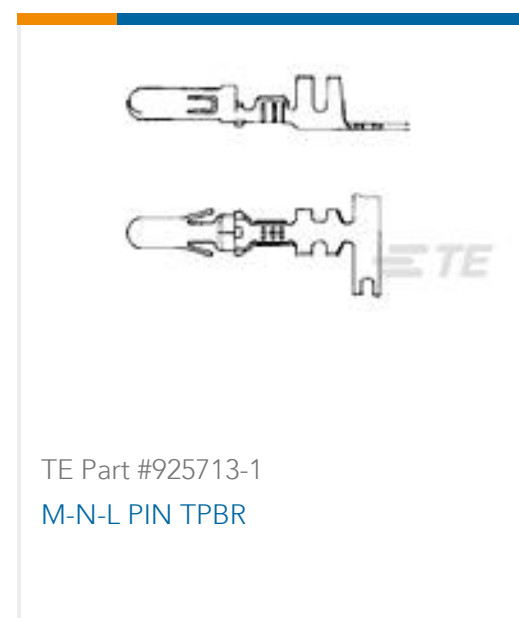
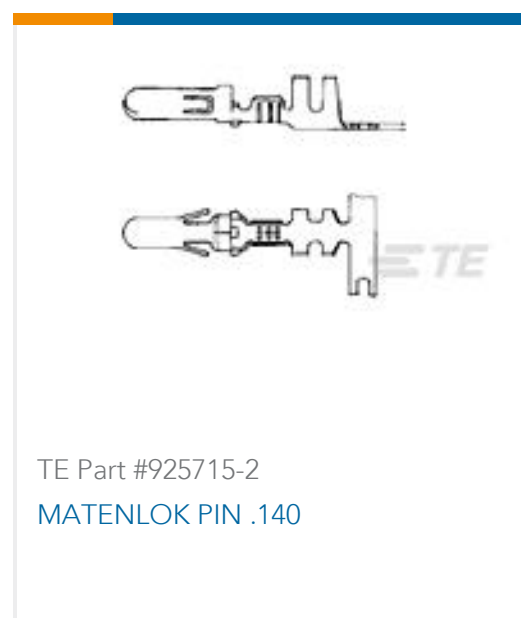



Documents

Product Drawings

[.140 DIA PIN](#)

English

CAD Files

[3D PDF](#)

English

Customer View Model

[ENG_CVM_925713-2_L.2d_dxf.zip](#)

English

Customer View Model

[ENG_CVM_925713-2_L.3d_igs.zip](#)

English

Customer View Model

[ENG_CVM_925713-2_L.3d_stp.zip](#)

English

By downloading the CAD file I accept and agree to the [Terms and Conditions](#) of use.

Product Specifications

[Product Specification](#)

English

Product Environmental Compliance

[Product Compliance](#)

English

[Product Compliance](#)

English