



MATE-N-LOK | Universal MATE-N-LOK

TE Internal #: 926893-3

Power Contacts, Contact, 600 VAC, Pre-Tin, 20 – 14 AWG Wire Size, .5 – 2.1 mm<sup>2</sup> Wire Size, Wire-to-Wire, Wire & Cable, Crimp, Universal MATE-N-LOK

[View on TE.com >](#)

Connectors > Power Connectors > Power Contacts

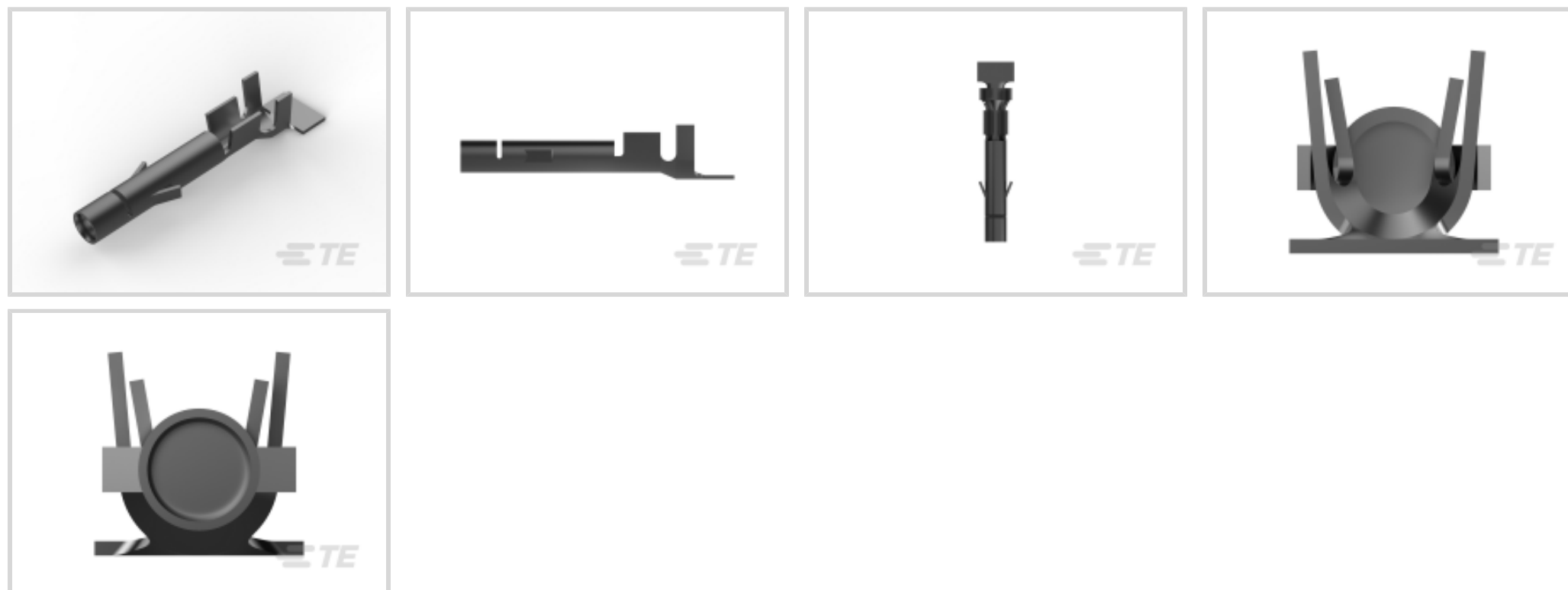

Power Contact Type: **Contact**

Operating Voltage: **600 VAC**

Contact Mating Area Plating Material: **Pre-Tin**

Wire Size: **.5 – 2.1 mm<sup>2</sup>**

**Features**

**Product Type Features**

Power Contact Type	Contact
Connector System	Wire-to-Wire
Connector & Contact Terminates To	Wire & Cable

**Electrical Characteristics**

Operating Voltage	600 VAC
-------------------	---------

**Contact Features**

Contact Shape & Form	Split
Contact Mating Area Plating Material	Pre-Tin
Contact Current Rating (Max)	19 A
Contact Type	Socket
Contact Retention Within Housing	With
Mating Pin Diameter	2.06 mm[.081 in]
Contact Base Material	Phosphor Bronze
Wire Contact Termination Area Plating Material	Tin
Wire Contact Termination Area Plating Material Finish	Matte



Contact Orientation	Straight
---------------------	----------

### Termination Features

Termination Method to Wire & Cable	Crimp
------------------------------------	-------

### Mechanical Attachment

Contact Retention Type Within Housing	Locking Lance
---------------------------------------	---------------

Connector Mounting Type	Cable Mount (Free-Hanging)
-------------------------	----------------------------

Wire Insulation Support	Without
-------------------------	---------

### Dimensions

Wire Size	.5 – 2.1 mm <sup>2</sup>
-----------	--------------------------

Accepts Wire Insulation Diameter Range	3.3 mm[.13 in]
--	----------------

### Usage Conditions

Operating Temperature Range	-55 – 105 °C[-67 – 221 °F]
-----------------------------	----------------------------

### Operation/Application

Circuit Application	Power
---------------------	-------

### Industry Standards

CSA Rating	Certified
------------	-----------

Glow Wire Rating	Standard Part - Not Glow Wire
------------------	-------------------------------

VDE Tested	Yes
------------	-----

Agency/Standard	CSA, UL
-----------------	---------

CSA File Number	LR 7189
-----------------	---------

UL Rating	Recognized
-----------	------------

UL File Number	E28476
----------------	--------

### Packaging Features

Packaging Method	Box
------------------	-----

Packaging Quantity	1000
--------------------	------

### Other

Wire/Cable Type	Discrete Wire
-----------------	---------------

Wire Type	Stranded
-----------	----------

### Product Compliance

[For compliance documentation, visit the product page on TE.com>](#)



EU RoHS Directive 2011/65/EU	Compliant
EU ELV Directive 2000/53/EC	Compliant
China RoHS 2 Directive MIIT Order No 32, 2016	No Restricted Materials Above Threshold
EU REACH Regulation (EC) No. 1907/2006	Current ECHA Candidate List: JUNE 2022 (224) Candidate List Declared Against: JUL 2021 (219) SVHC > Threshold: Not Yet Reviewed
Halogen Content	Low Halogen - Br, Cl, F, I < 900 ppm per homogenous material. Also BFR/CFR/PVC Free
Solder Process Capability	Not applicable for solder process capability

Product Compliance Disclaimer

This information is provided based on reasonable inquiry of our suppliers and represents our current actual knowledge based on the information they provided. This information is subject to change. The part numbers that TE has identified as EU RoHS compliant have a maximum concentration of 0.1% by weight in homogenous materials for lead, hexavalent chromium, mercury, PBB, PBDE, DBP, BBP, DEHP, DIBP, and 0.01% for cadmium, or qualify for an exemption to these limits as defined in the Annexes of Directive 2011/65/EU (RoHS2). Finished electrical and electronic equipment products will be CE marked as required by Directive 2011/65/EU. Components may not be CE marked. Additionally, the part numbers that TE has identified as EU ELV compliant have a maximum concentration of 0.1% by weight in homogenous materials for lead, hexavalent chromium, and mercury, and 0.01% for cadmium, or qualify for an exemption to these limits as defined in the Annexes of Directive 2000/53/EC (ELV). Regarding the REACH Regulation, the information TE provides on SVHC in articles for this part number is based on the latest European Chemicals Agency (ECHA) 'Guidance on requirements for substances in articles' posted at this URL: <https://echa.europa.eu/guidance-documents/guidance-on-reach>

## Compatible Parts

TE Part # 539972-1  
EXTRACTION TOOL

TE Part # 455830-1  
INSERTION TOOL

TE Part # 1-480705-2  
06P UNML CAP HSG RED

TE Part # 350784-1  
15P UMNL CAP HSG

TE Part # 926307-3  
6P UN-MNL AUFN-GEH

TE Part # 1-480704-2  
06P UMNL PLUG HSG RED

TE Part # 926302-1  
10& UNIV.M-N-L.PLUG

TE Part # 1-350777-2  
02P UMNL V0 PLUG HSG RED



Also in the Series | **Universal MATE-N-LOK**

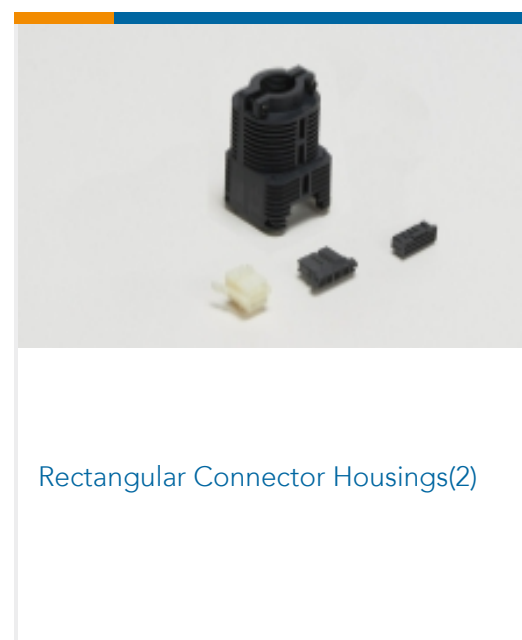
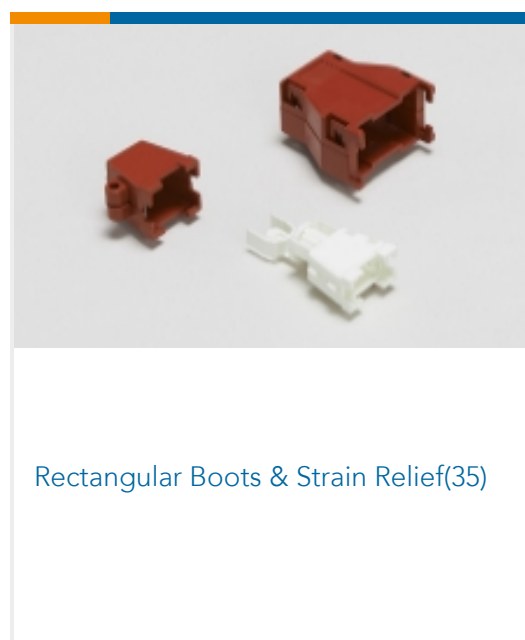
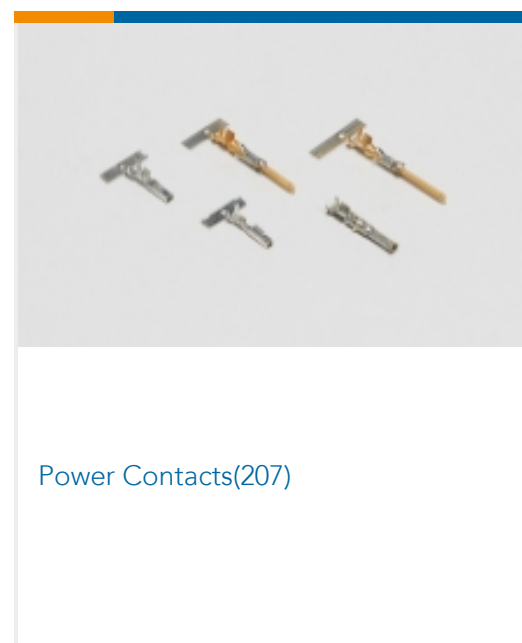
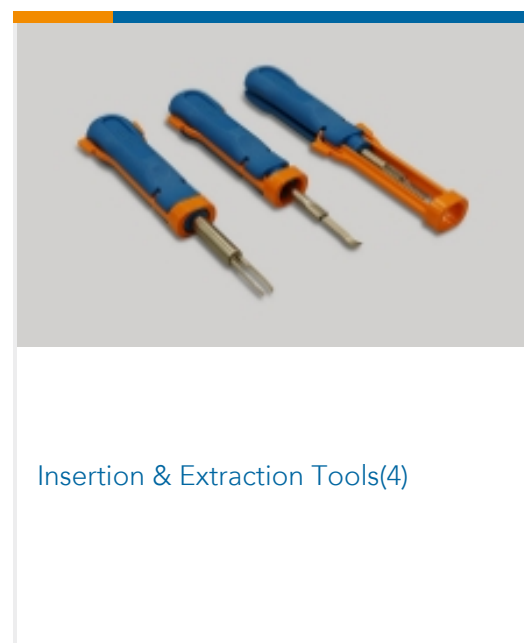
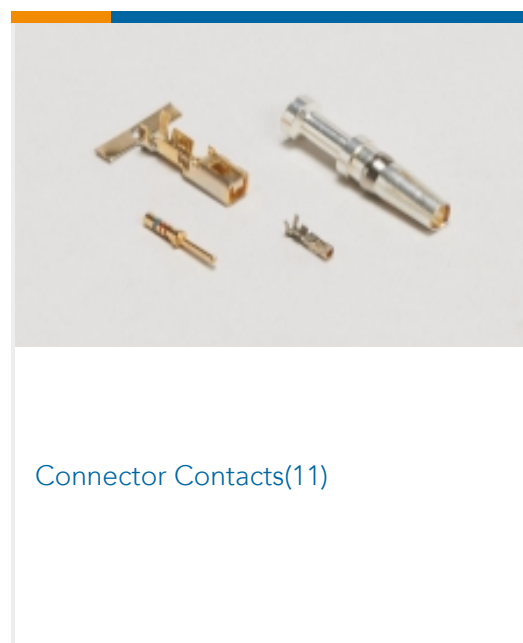
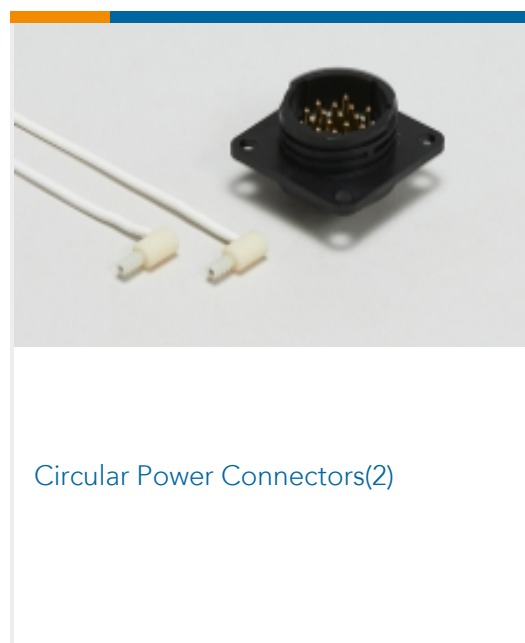

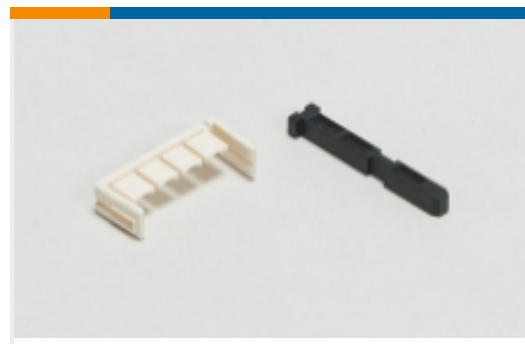

Rectangular Connector Keying Plugs(3)



Rectangular Connector Locking(4)

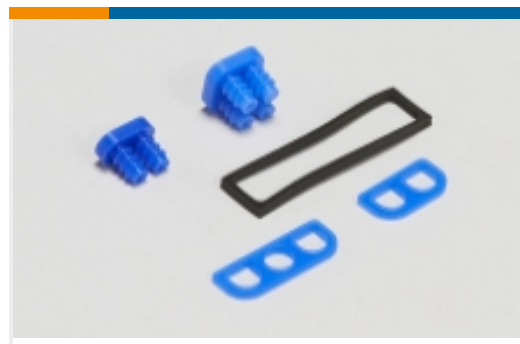

Rectangular Connector Seals(26)



Rectangular Power Connectors(729)

## Customers Also Bought



TE Part #926898-3  
UNIV.M-N-L.PIN



TE Part #926898-1  
UNIV.M-N-L.PIN



TE Part #926895-3  
UNIVERSAL M-N-L SOCKET



TE Part #350766-1  
03P UMNL PLUG HSG

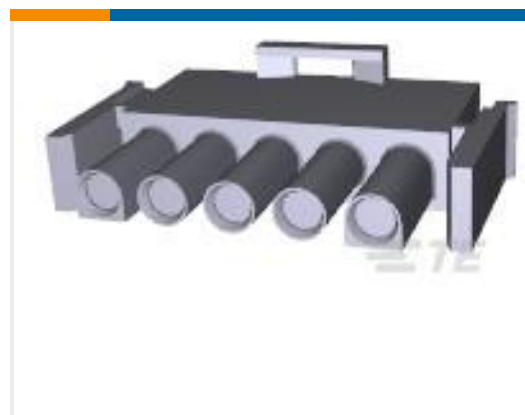

TE Part #350809-1  
05P UMNL PLUG HSG



TE Part #1241964-6  
STD TIM HOUSING 6P



TE Part #1742971-4  
FASTON 250 REC 18-14 AWG TPBR

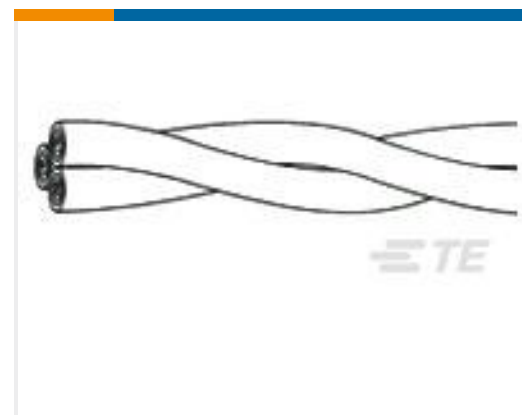

TE Part #3699623001  
44A0331-20-0/2/9

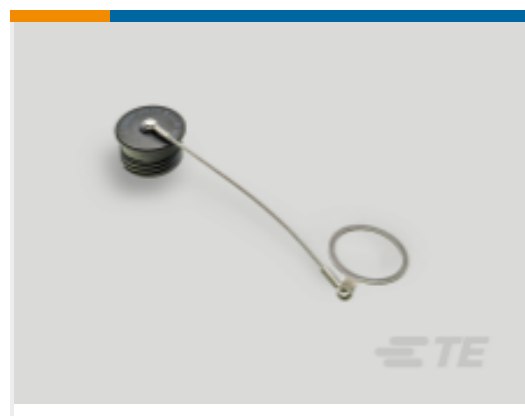

TE Part #YDTS32F19RV0010000  
DTS CAP ASSY, NICKEL, SIZE 19 PLUG

## Documents

### Product Drawings

[UNIV.M-N-L.SOCKET](#)

English

### CAD Files

Customer View Model

[ENG\\_CVM\\_CVM\\_926893-3\\_K.2d\\_dxf.zip](#)

English

[3D PDF](#)



3D

Customer View Model

[ENG\\_CVM\\_CVM\\_926893-3\\_K.3d\\_igs.zip](#)

English

Customer View Model

[ENG\\_CVM\\_CVM\\_926893-3\\_K.3d\\_stp.zip](#)

English

By downloading the CAD file I accept and agree to the [Terms and Conditions](#) of use.

---

### Product Environmental Compliance

[MD\\_926893-3\\_04022018031\\_dmtec](#)

English

[MD\\_926893-3\\_04022018031\\_dmtec](#)

English

---

### Agency Approvals

[VDE Certificate](#)

English