

926477-1 ✓ ACTIVE

AMPMODU | AMPMODU IV/V

TE Internal #: 926477-1

PCB Latches, Locks & Retainers, Retention Plug, Signal, -65 – 105 °

C [-85 – 221 °F], AMPMODU IV/V

[View on TE.com >](#)



Connectors > PCB Connectors > PCB Connector Accessories > PCB Connector Hardware > PCB Latches, Locks & Retainers

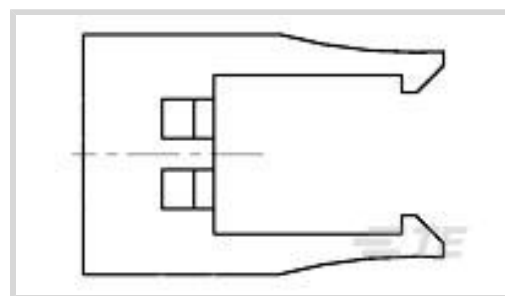

Connector & Contact Retention Accessory Type: **Retention Plug**

Contact Current Rating (Max): **3 A**

Circuit Application: **Signal**

Operating Temperature Range: **-65 – 105 °C [-85 – 221 °F]**

Features

Product Type Features

Connector & Contact Retention Accessory Type	Retention Plug
--	----------------

Body Features

Primary Product Material	Polycarbonate GF
Primary Product Color	Black

Contact Features

Contact Current Rating (Max)	3 A
------------------------------	-----

Usage Conditions

Operating Temperature Range	-65 – 105 °C[-85 – 221 °F]
-----------------------------	----------------------------

Operation/Application

Circuit Application	Signal
---------------------	--------

Industry Standards

Glow Wire Rating	Standard Part - Not Glow Wire
------------------	-------------------------------

Packaging Features

Packaging Quantity	15000
Packaging Method	Bag

Product Compliance

[For compliance documentation, visit the product page on TE.com>](#)

EU RoHS Directive 2011/65/EU	Compliant
------------------------------	-----------



EU ELV Directive 2000/53/EC	Compliant
China RoHS 2 Directive MIIT Order No 32, 2016	No Restricted Materials Above Threshold
EU REACH Regulation (EC) No. 1907/2006	<p>Current ECHA Candidate List: JUNE 2022 (224)</p> <p>Candidate List Declared Against: JAN 2022 (223)</p> <p>SVHC > Threshold:</p> <p>Perfluorobutane sulfonic acid (PFBS) and its salts (.2% in Component Part)</p> <p>Article Safe Usage Statements: Do not eat, drink or smoke when using this product. Wash thoroughly after handling. Recycle if possible and dispose of the article by following all applicable governmental regulations relevant to your geographic location.</p>
Halogen Content	Low Bromine/Chlorine - Br and Cl < 900 ppm per homogenous material. Also BFR /CFR/PVC Free
Solder Process Capability	Not applicable for solder process capability

Product Compliance Disclaimer

This information is provided based on reasonable inquiry of our suppliers and represents our current actual knowledge based on the information they provided. This information is subject to change. The part numbers that TE has identified as EU RoHS compliant have a maximum concentration of 0.1% by weight in homogenous materials for lead, hexavalent chromium, mercury, PBB, PBDE, DBP, BBP, DEHP, DIBP, and 0.01% for cadmium, or qualify for an exemption to these limits as defined in the Annexes of Directive 2011/65/EU (RoHS2). Finished electrical and electronic equipment products will be CE marked as required by Directive 2011/65/EU. Components may not be CE marked. Additionally, the part numbers that TE has identified as EU ELV compliant have a maximum concentration of 0.1% by weight in homogenous materials for lead, hexavalent chromium, and mercury, and 0.01% for cadmium, or qualify for an exemption to these limits as defined in the Annexes of Directive 2000/53/EC (ELV). Regarding the REACH Regulation, the information TE provides on SVHC in articles for this part number is based on the latest European Chemicals Agency (ECHA) 'Guidance on requirements for substances in articles' posted at this URL: <https://echa.europa.eu/guidance-documents/guidance-on-reach>

Compatible Parts

 <p>TE Part # 926476-8 MOD 4 HSG</p>	 <p>TE Part # 926475-3 03P MODU 4 HSG.S.R.</p>	 <p>TE Part # 926475-4 MOD 4 HSG</p>	 <p>TE Part # 926476-6 MOD 4 HSG</p>
---	--	---	---



Also in the Series | **AMP MODU IV/V**

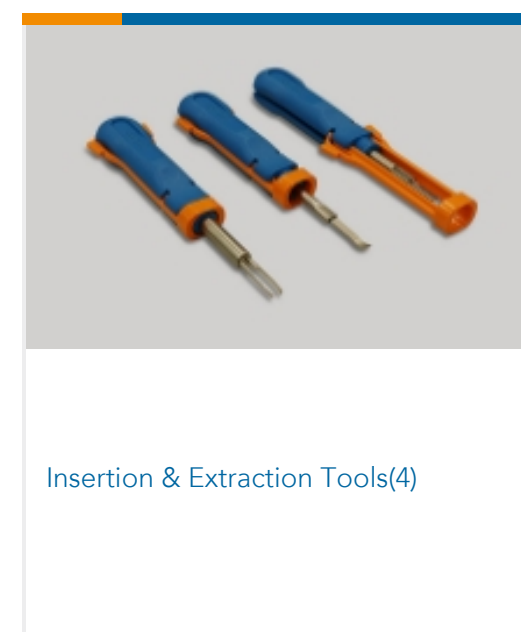
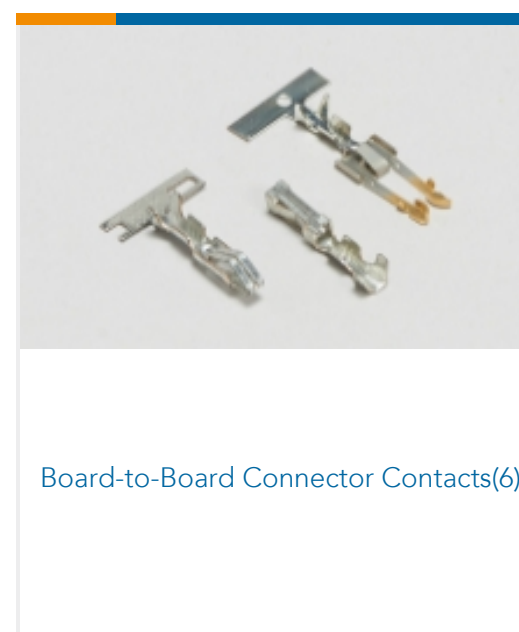
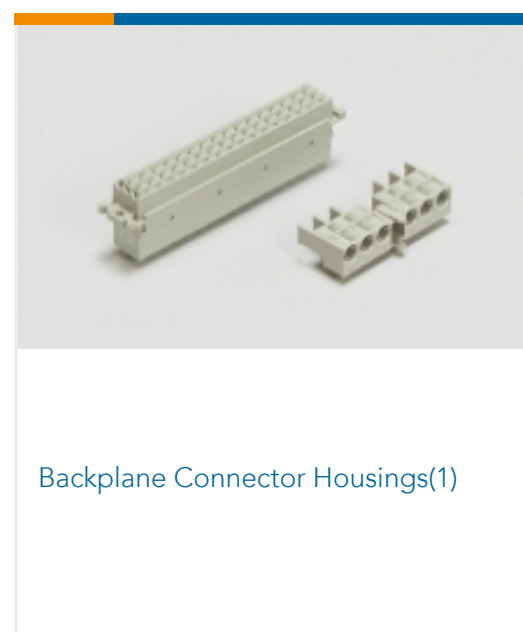
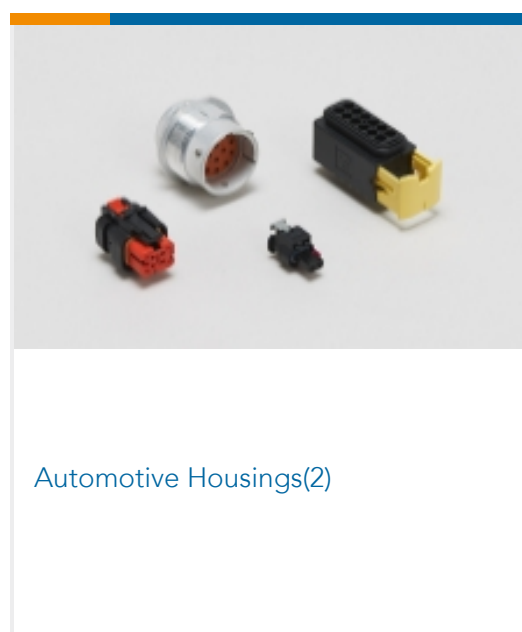

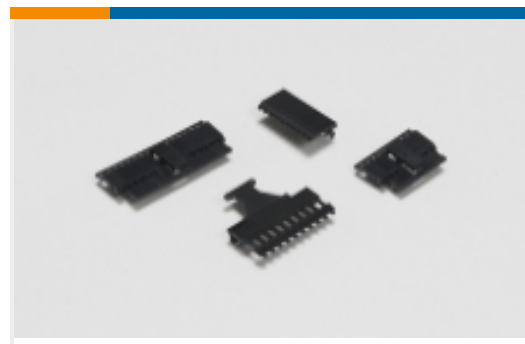

PCB Connector Covers(18)



PCB Connector Keying(6)

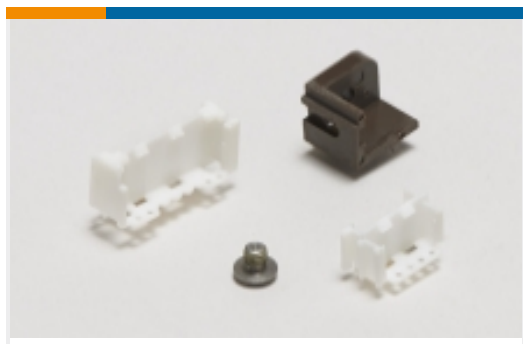

PCB Connector Mounting(1)

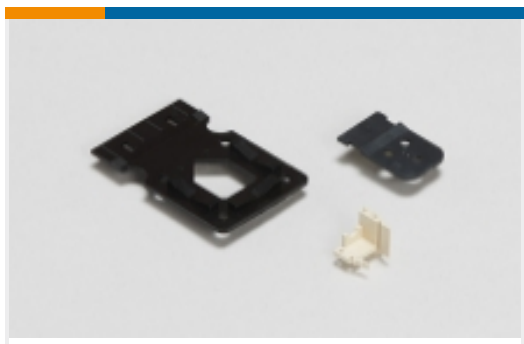

PCB Connector Strain Relief(3)

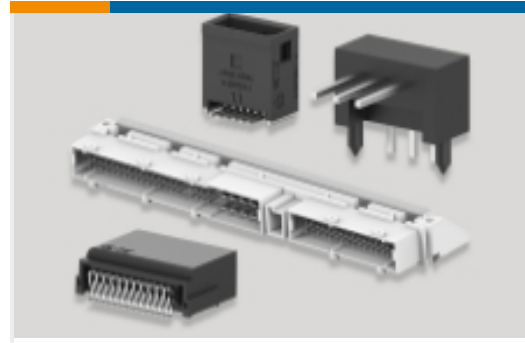

PCB Headers & Receptacles(939)

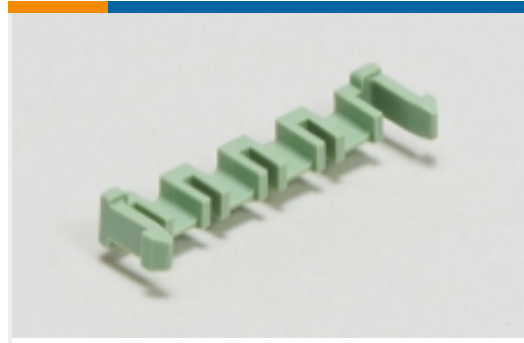

PCB Latches, Locks & Retainers(9)



Rectangular Connector Housings(5)



Standard Rectangular Connectors(8)



Wire-to-Board Connector Assemblies & Housings(467)



Wire-to-Board Connector Contacts (326)

Customers Also Bought

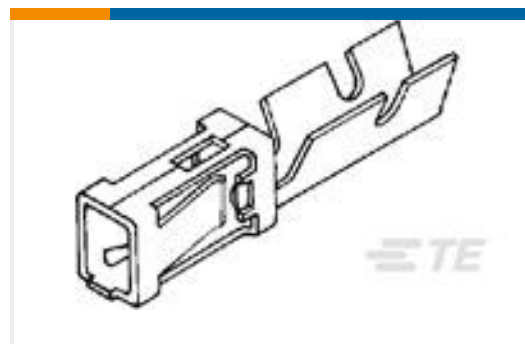

TE Part #280621-2
MOD I CONT STRIP



TE Part #9-927742-2
2POS FASTIN FASTON HOUSING



TE Part #926476-6
MOD 4 HSG



TE Part #1-926476-0
MOD 4 HSG

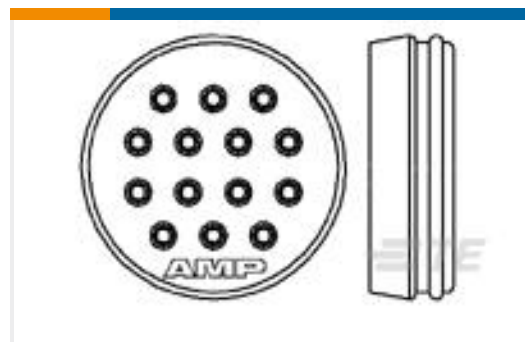

TE Part #213919-2
CPC SEAL KIT, UNASSM, SZ 17-14



TE Part #926476-3
MOD 4 HSG



TE Part #926476-7
MOD 4 HSG

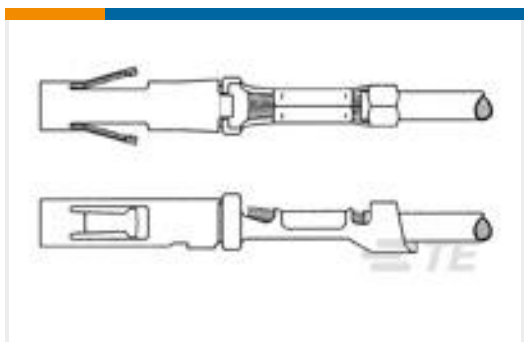

TE Part #164153-6
CONTACT, SOCKET, CRIMP, TYPE XI

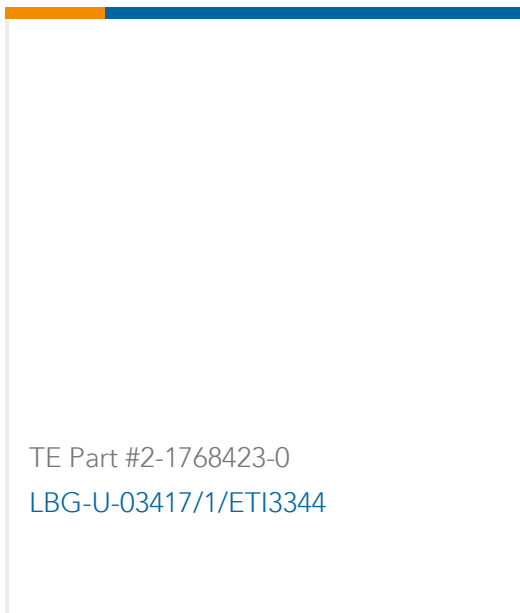

Documents

Product Drawings

RETENTION FORK

English

CAD Files

Customer View Model

[ENG_CVM_926477-1_P0F1.3d_igs.zip](#)

English

Customer View Model

[ENG_CVM_926477-1_P0F1.3d_stp.zip](#)

English

Customer View Model

[ENG_CVM_926477-1_P0F1.2d_dxf.zip](#)

English

3D PDF

English

By downloading the CAD file I accept and agree to the [Terms and Conditions](#) of use.

Product Specifications

Product Specification

English

Product Environmental Compliance

Product Compliance

English

Product Compliance

English