

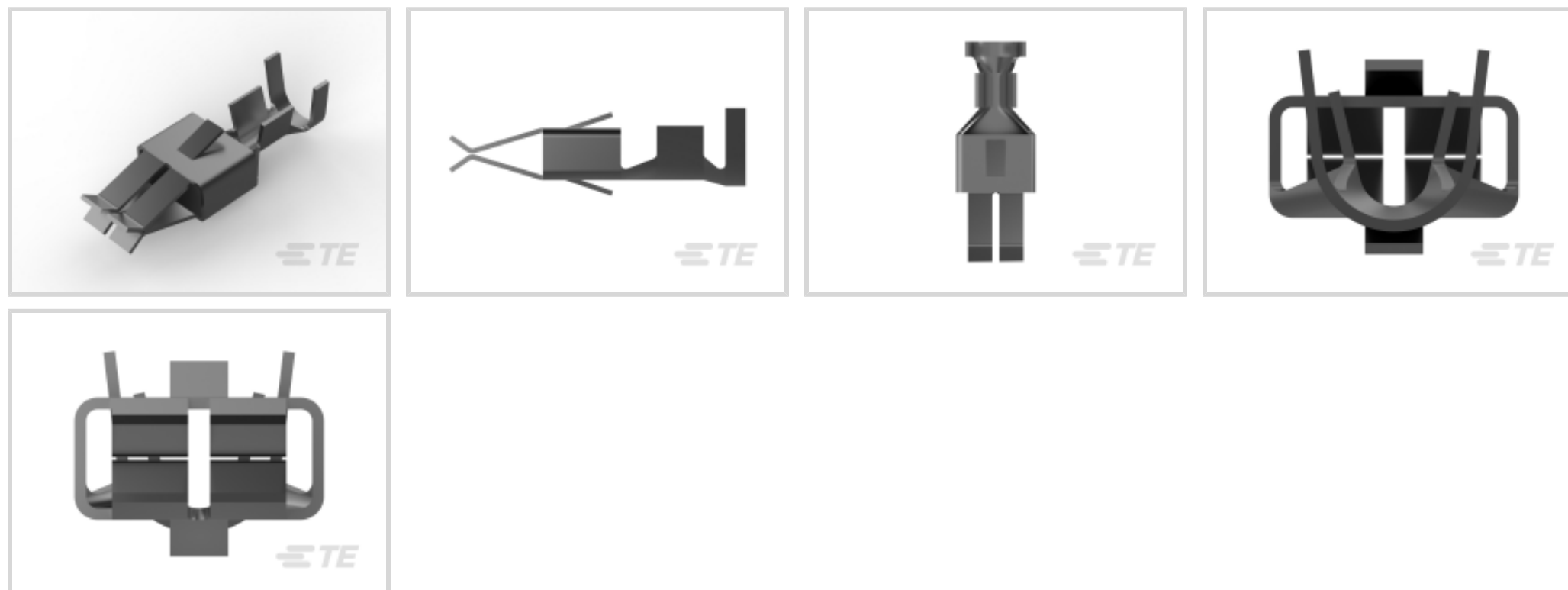

Terminals & Splices > Automotive Terminals



Terminal Type: **Receptacle**

Mating Tab Width: **5.8 mm [.228 in]**

Mating Tab Thickness: **.8 mm [.031 in]**

Terminal Transmits: **0 – 24 A (Low Power)**

Wire Size: **17 – 13 AWG**

Features

Product Type Features

Sealable	No
Primary Locking Feature	Locking Lance

Contact Features

Contact Size	6.3mm
Contact Fabrication	Stamped & Formed
Crimp Type	F-Crimp
Terminal Type	Receptacle
Mating Tab Width	5.8 mm[.228 in]
Mating Tab Thickness	.8 mm[.031 in]
Interface Plating	Tin (Sn)

Termination Features

Termination Method to Wire & Cable	Crimp
Product Terminates To	Wire

Dimensions



Wire Size	1 – 2.5 mm ²
Wire Size Search	13 AWG, 14 AWG, 15 AWG, 16 AWG, 17 AWG

Usage Conditions

Insulation Option	Uninsulated
Operating Temperature (Max)	80 °C, 85 °C, 90 °C, 100 °C, 105 °C, 110 °C, 120 °C, 125 °C, 130 °C[176 °F][185 °F][194 °F][212 °F][221 °F][230 °F][248 °F][257 °F][266 °F]
Operating Temperature Range	-40 – 130 °C[-40 – 266 °F]

Operation/Application

Compatible With Wire Base Material	Copper
------------------------------------	--------

Packaging Features

Packaging Method	Reel
Packaging Quantity	2000

Other

Terminal Transmits	0 – 24 A (Low Power)
--------------------	----------------------

Product Compliance

[For compliance documentation, visit the product page on TE.com>](#)

EU RoHS Directive 2011/65/EU	Compliant
EU ELV Directive 2000/53/EC	Compliant
China RoHS 2 Directive MIIT Order No 32, 2016	No Restricted Materials Above Threshold
EU REACH Regulation (EC) No. 1907/2006	Current ECHA Candidate List: JUNE 2022 (224) Candidate List Declared Against: JAN 2022 (223) SVHC > Threshold: Not Yet Reviewed
Halogen Content	Low Halogen - Br, Cl, F, I < 900 ppm per homogenous material. Also BFR/CFR/PVC Free
Solder Process Capability	Not applicable for solder process capability

Product Compliance Disclaimer

This information is provided based on reasonable inquiry of our suppliers and represents our current actual knowledge based on the information they provided. This information is subject to change. The part numbers that TE has identified as EU RoHS compliant have a maximum concentration of 0.1% by weight in homogenous materials for lead, hexavalent

chromium, mercury, PBB, PBDE, DBP, BBP, DEHP, DIBP, and 0.01% for cadmium, or qualify for an exemption to these limits as defined in the Annexes of Directive 2011/65/EU (RoHS2). Finished electrical and electronic equipment products will be CE marked as required by Directive 2011/65/EU. Components may not be CE marked. Additionally, the part numbers that TE has identified as EU ELV compliant have a maximum concentration of 0.1% by weight in homogenous materials for lead, hexavalent chromium, and mercury, and 0.01% for cadmium, or qualify for an exemption to these limits as defined in the Annexes of Directive 2000/53/EC (ELV). Regarding the REACH Regulation, the information TE provides on SVHC in articles for this part number is based on the latest European Chemicals Agency (ECHA) 'Guidance on requirements for substances in articles' posted at this URL: <https://echa.europa.eu/guidance-documents/guidance-on-reach>

Compatible Parts



TE Part # 1-1579007-4
EXTRACTION TOOL



TE Part # 4-1579007-3
EXTRACTION TOOL KIT



TE Part # 2305570-1
TERMINAL CUTTER, SIDE FEED



TE Part # 1241959-4
STD-TIM HSG MKII 4P



TE Part # 1-2178571-3
STANDARD TIMER HSG 3P



TE Part # 1-2315717-2
STD TIMER PLUG HSG 2P MKII



TE Part # 2-2151245-2
OCEAN_2.0_Applicator-S-110F155F



TE Part # 2-2315717-2
STD TIMER PLUG HSG 2P MKII



TE Part # 2151245-2
OCEAN_2.0_Applicator-S-110F155F



TE Part # 7-2151245-2
OCEAN_2.0_Applicator-S-110F155F

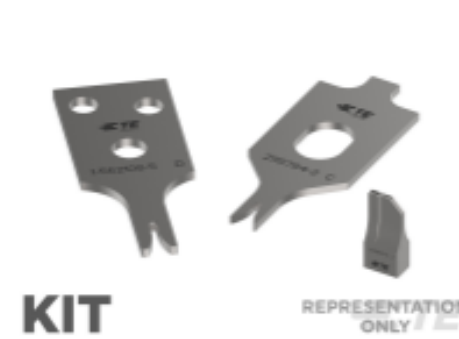

TE Part # 7-2151245-7
OCEAN_2.0_SPARE_PART_KIT-110F155F

Also in the Series | RAST 5 IDC Connectors

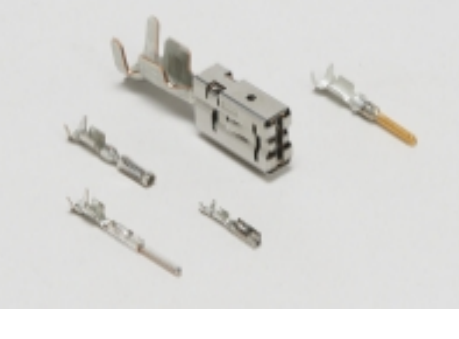

Automotive Terminals(8)



Connector Contacts(12)

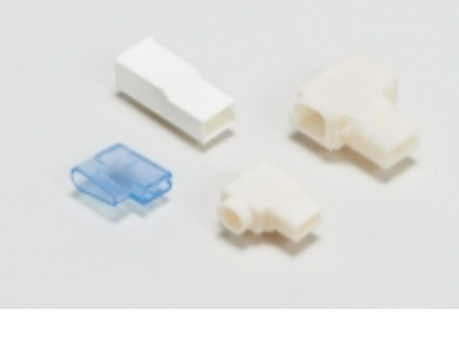

Crimp Terminal Housings(41)



Insertion & Extraction Tools(1)



PCB Headers & Receptacles(424)



Rectangular Connector Housings(1)



Standard Edge Connectors(47)



Standard Rectangular Connectors(112)



Wire-to-Board Connector Assemblies & Housings(213)



Wire-to-Board Connector Contacts(2)

Customers Also Bought



TE Part #928247-3
3P ST-TIMER GEH



TE Part #964201-1
STD TIMER CONTACT



TE Part #928343-8
STD-TIMER GEH 8P



TE Part #928343-6
STD-TIM GEH 6P

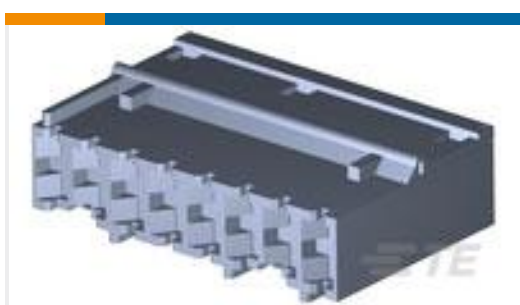

TE Part #3-928343-8
STD-TIMER GEH 8P



TE Part #2-321518-1
TERMINAL,PG R 16-14HD 10



TE Part #2238196-3
250 FASTON,REC.,18-14 AWG,TPBR



TE Part #2238207-3
187 FASTON,REC.,20-16 AWG,TPBR



TE Part #1969897-1
250 FASTON HSG.,REC.,5 POS,BLACK

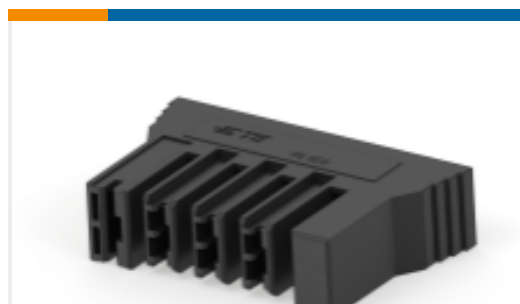

TE Part #1969898-1
250 & 187 FASTON HSG.,REC.,4 POS, BLACK

Documents



Product Drawings

STD TIMER CONTACT

English

CAD Files

Customer View Model

[ENG_CVM_CVM_964202-1_C.2d_dxf.zip](#)

English

3D PDF

3D

Customer View Model

[ENG_CVM_CVM_964202-1_C.3d_igs.zip](#)

English

Customer View Model

[ENG_CVM_CVM_964202-1_C.3d_stp.zip](#)

English

By downloading the CAD file I accept and agree to the [Terms and Conditions](#) of use.

Datasheets & Catalog Pages

[1654742_HOUSEHOLD_APPLIANCES_RAST5](#)

English

Product Specifications

Application Specification

German

Application Specification

English

Application Specification

English

Product Environmental Compliance

[MD_964202-1_030620182151_dmtec](#)

English

[MD_964202-1_030620182151_dmtec](#)

English