

964783-1 ✓ ACTIVE

AMP | Timer Connector System

TE Internal #: 964783-1

Automotive Connector Caps & Covers, Cover - Cable Exit, Cable Exit Angle 90° (Right Angle), Black, PA, Timer Connector System

[View on TE.com >](#)



Connectors > Automotive Connectors > Connector Accessories > Connector Caps & Covers



Protection & Strain Relief Accessory Type: **Cover - Cable Exit**

Cable Exit Angle: **90° (Right Angle)**

Strain Relief: **Without**

Primary Product Color: **Black**

Primary Product Material: **PA**

Features

Product Type Features

Protection & Strain Relief Accessory Type	Cover - Cable Exit
Connector System	Wire-to-Board, Wire-to-Device

Configuration Features

Number of Positions	25
---------------------	----

Body Features

Cable Exit Angle	90° (Right Angle)
Primary Product Color	Black
Primary Product Material	PA

Mechanical Attachment

Strain Relief	Without
---------------	---------

Dimensions

Compatible Cable Bundle Diameter Range	25 mm[.984 in]
--	----------------

Usage Conditions

Operating Temperature (Max)	70 °C, 75 °C, 80 °C, 85 °C, 90 °C, 100 °C,
-----------------------------	--



	105 °C, 110 °C, 120 °C[158 °F][167 °F][176 °F][185 °F][194 °F][212 °F][221 °F][230 °F][248 °F]
Operating Temperature Range	-40 – 120 °C[-40 – 248 °F]

Industry Standards

UL Flammability Rating	UL 94HB
------------------------	---------

Packaging Features

Packaging Method	Carton
------------------	--------

Other

Serviceable	Yes
-------------	-----

Product Compliance

[For compliance documentation, visit the product page on TE.com>](#)

EU RoHS Directive 2011/65/EU	Compliant
EU ELV Directive 2000/53/EC	Compliant
China RoHS 2 Directive MIIT Order No 32, 2016	No Restricted Materials Above Threshold
EU REACH Regulation (EC) No. 1907/2006	Current ECHA Candidate List: JUNE 2022 (224) Candidate List Declared Against: JUL 2019 (201) SVHC > Threshold: Not Yet Reviewed
Halogen Content	BFR/CFR/PVC Free, but Br/Cl >900 ppm in other sources.
Solder Process Capability	Not applicable for solder process capability

Product Compliance Disclaimer

This information is provided based on reasonable inquiry of our suppliers and represents our current actual knowledge based on the information they provided. This information is subject to change. The part numbers that TE has identified as EU RoHS compliant have a maximum concentration of 0.1% by weight in homogenous materials for lead, hexavalent chromium, mercury, PBB, PBDE, DBP, BBP, DEHP, DIBP, and 0.01% for cadmium, or qualify for an exemption to these limits as defined in the Annexes of Directive 2011/65/EU (RoHS2). Finished electrical and electronic equipment products will be CE marked as required by Directive 2011/65/EU. Components may not be CE marked. Additionally, the part numbers that TE has identified as EU ELV compliant have a maximum concentration of 0.1% by weight in homogenous materials for lead, hexavalent chromium, and mercury, and 0.01% for cadmium, or qualify for an exemption to these limits as defined in the Annexes of Directive 2000/53/EC (ELV). Regarding the REACH Regulation, the information TE provides on SVHC in articles for this part number is based on the latest European Chemicals Agency (ECHA) 'Guidance on requirements for substances in articles' posted at this URL: <https://echa.europa.eu/guidance-documents/guidance-on-reach>

Compatible Parts

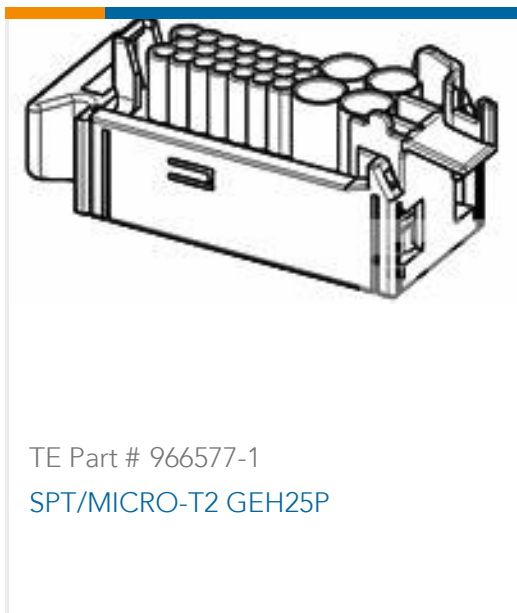

TE Part # 966577-1
SPT/MICRO-T2 GEH25P

Also in the Series | Timer Connector System



Automotive Connector Caps & Covers (11)



Automotive Connector Locks & Position Assurance(16)

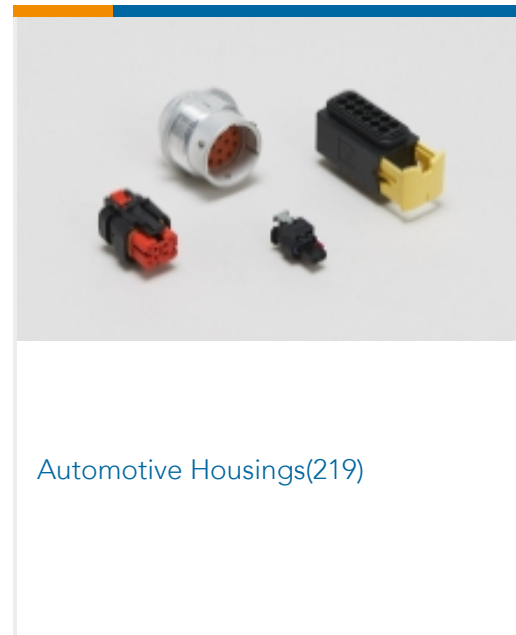

Automotive Housings(219)

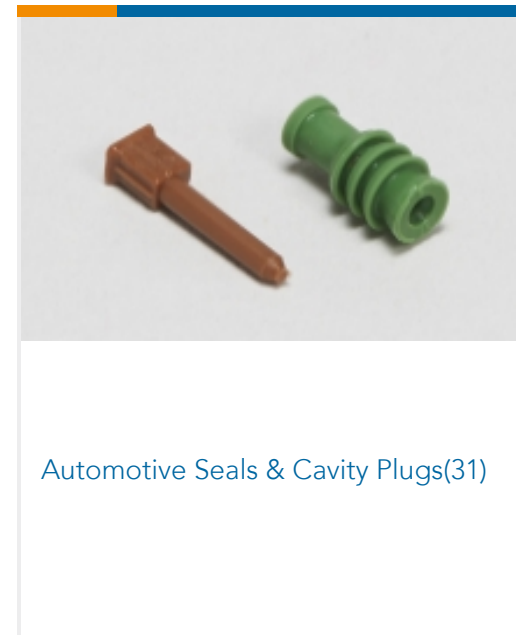

Automotive Seals & Cavity Plugs(31)

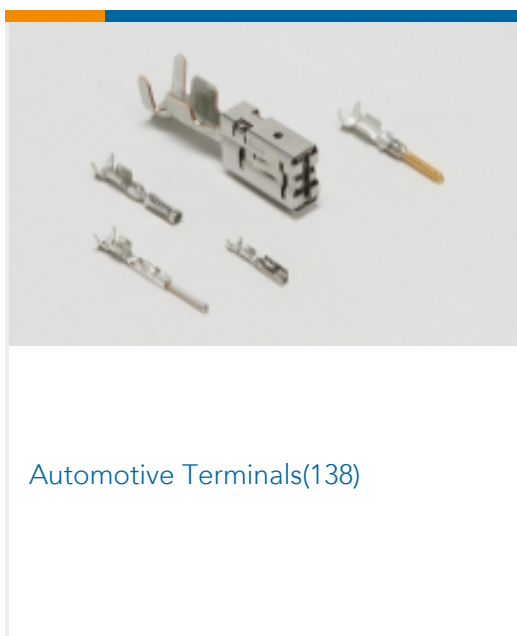

Automotive Terminals(138)

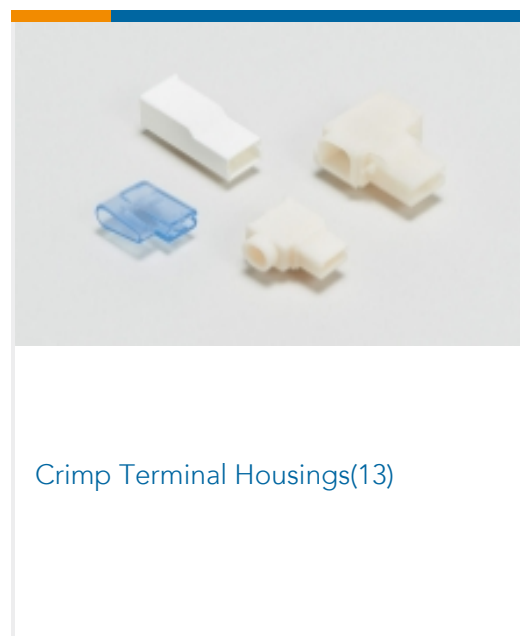

Crimp Terminal Housings(13)

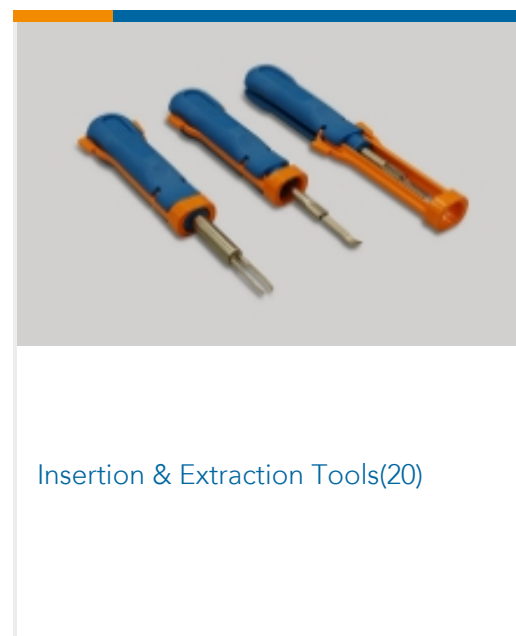

Insertion & Extraction Tools(20)

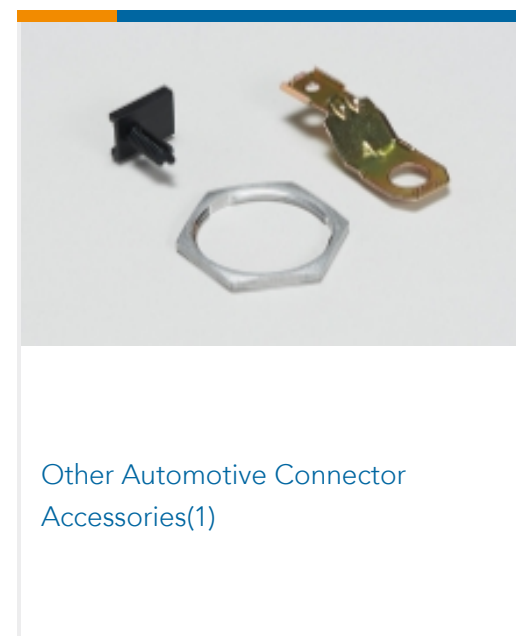

Other Automotive Connector Accessories(1)



PCB Headers & Receptacles(78)

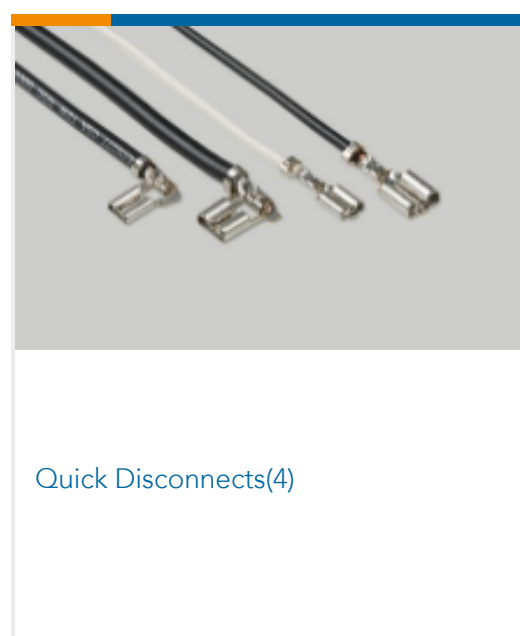

Quick Disconnects(4)

Customers Also Bought

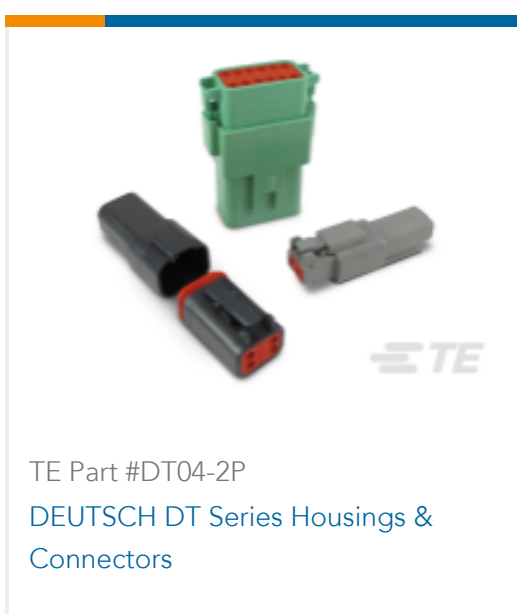

TE Part #DT04-2P
DEUTSCH DT Series Housings & Connectors



TE Part #W2S
DEUTSCH DT WEDGELOCKS



TE Part #282104-1
AMP SUPERSEAL 1.5MM, CONNECTOR HOUSING



TE Part #206070-8
CABLE CLAMP KIT #17



Documents

Product Drawings

[ABDECKKAPPE F25P](#)

English

CAD Files

[3D PDF](#)

3D

Customer View Model

[ENG_CVM_CVM_964783-1_A.2d_dxf.zip](#)

English

Customer View Model

[ENG_CVM_CVM_964783-1_A.3d_igs.zip](#)

English

Customer View Model

[ENG_CVM_CVM_964783-1_A.3d_stp.zip](#)

English

By downloading the CAD file I accept and agree to the [Terms and Conditions](#) of use.