

926893-1 ✓ ACTIVE

MATE-N-LOK | Universal MATE-N-LOK

TE Internal #: 926893-1

Power Contacts, Contact, 600 VAC, Pre-Tin, 20 – 14 AWG Wire Size,
.5 – 2.1 mm² Wire Size, Wire-to-Wire, Wire & Cable, Crimp,
Universal MATE-N-LOK

[View on TE.com >](#)



Connectors > Power Connectors > Power Contacts

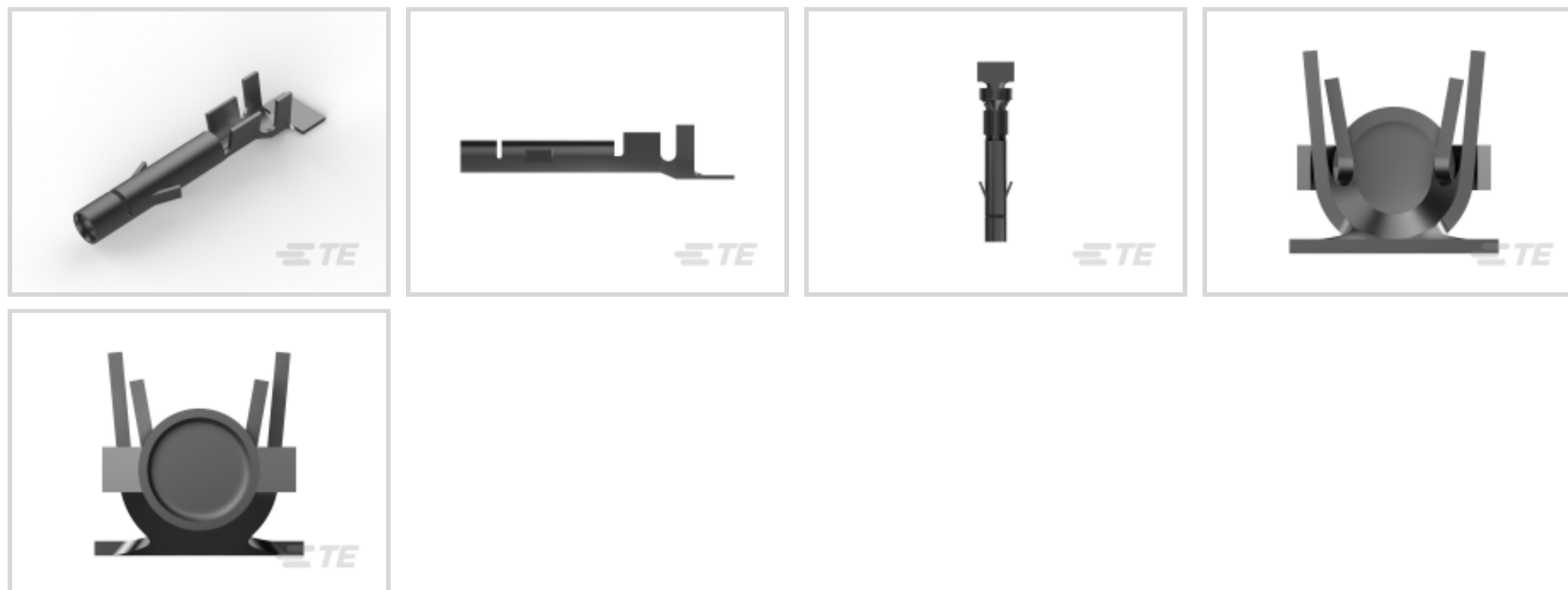

Power Contact Type: **Contact**

Operating Voltage: **600 VAC**

Contact Mating Area Plating Material: **Pre-Tin**

Wire Size: **.5 – 2.1 mm²**

Features

Product Type Features

Power Contact Type	Contact
Connector System	Wire-to-Wire
Connector & Contact Terminates To	Wire & Cable

Electrical Characteristics

Operating Voltage	600 VAC
-------------------	---------

Contact Features

Contact Shape & Form	Split
Contact Mating Area Plating Material	Pre-Tin
Contact Current Rating (Max)	19 A
Contact Type	Socket
Contact Retention Within Housing	With
Mating Pin Diameter	2.06 mm[.081 in]
Contact Base Material	Brass
Wire Contact Termination Area Plating Material	Tin
Wire Contact Termination Area Plating Material Finish	Bright



Contact Orientation	Straight
---------------------	----------

Termination Features

Termination Method to Wire & Cable	Crimp
------------------------------------	-------

Mechanical Attachment

Contact Retention Type Within Housing	Locking Lance
---------------------------------------	---------------

Connector Mounting Type	Cable Mount (Free-Hanging)
-------------------------	----------------------------

Wire Insulation Support	Without
-------------------------	---------

Dimensions

Wire Size	.5 – 2.1 mm ²
-----------	--------------------------

Accepts Wire Insulation Diameter Range	3.3 mm[.13 in]
--	----------------

Usage Conditions

Operating Temperature Range	-55 – 105 °C[-67 – 221 °F]
-----------------------------	----------------------------

Operation/Application

Circuit Application	Power
---------------------	-------

Industry Standards

CSA Rating	Certified
------------	-----------

Glow Wire Rating	Standard Part - Not Glow Wire
------------------	-------------------------------

VDE Tested	Yes
------------	-----

Agency/Standard	CSA, UL
-----------------	---------

CSA File Number	LR 7189
-----------------	---------

UL Rating	Recognized
-----------	------------

UL File Number	E28476
----------------	--------

Packaging Features

Packaging Method	Bag
------------------	-----

Packaging Quantity	2000
--------------------	------

Other

Wire/Cable Type	Discrete Wire
-----------------	---------------

Wire Type	Stranded
-----------	----------

Product Compliance

[For compliance documentation, visit the product page on TE.com>](#)





EU RoHS Directive 2011/65/EU	Compliant
EU ELV Directive 2000/53/EC	Compliant
China RoHS 2 Directive MIIT Order No 32, 2016	No Restricted Materials Above Threshold
EU REACH Regulation (EC) No. 1907/2006	Current ECHA Candidate List: JUNE 2022 (224) Candidate List Declared Against: JAN 2022 (223) SVHC > Threshold: Not Yet Reviewed
Halogen Content	Low Halogen - Br, Cl, F, I < 900 ppm per homogenous material. Also BFR/CFR/PVC Free
Solder Process Capability	Not applicable for solder process capability

Product Compliance Disclaimer

This information is provided based on reasonable inquiry of our suppliers and represents our current actual knowledge based on the information they provided. This information is subject to change. The part numbers that TE has identified as EU RoHS compliant have a maximum concentration of 0.1% by weight in homogenous materials for lead, hexavalent chromium, mercury, PBB, PBDE, DBP, BBP, DEHP, DIBP, and 0.01% for cadmium, or qualify for an exemption to these limits as defined in the Annexes of Directive 2011/65/EU (RoHS2). Finished electrical and electronic equipment products will be CE marked as required by Directive 2011/65/EU. Components may not be CE marked. Additionally, the part numbers that TE has identified as EU ELV compliant have a maximum concentration of 0.1% by weight in homogenous materials for lead, hexavalent chromium, and mercury, and 0.01% for cadmium, or qualify for an exemption to these limits as defined in the Annexes of Directive 2000/53/EC (ELV). Regarding the REACH Regulation, the information TE provides on SVHC in articles for this part number is based on the latest European Chemicals Agency (ECHA) 'Guidance on requirements for substances in articles' posted at this URL: <https://echa.europa.eu/guidance-documents/guidance-on-reach>

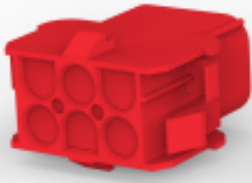
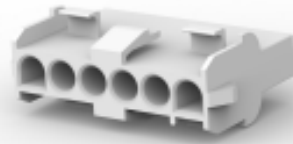
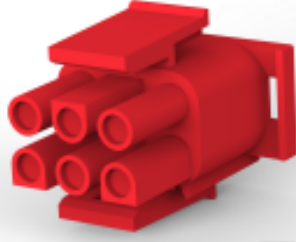
Compatible Parts

 <p>TE Part # 539972-1 EXTRACTION TOOL</p>	 <p>TE Part # 455830-1 INSERTION TOOL</p>	 <p>TE Part # 1-480705-2 06P UNML CAP HSG RED</p>	 <p>TE Part # 350784-1 15P UMNL CAP HSG</p>
 <p>TE Part # 926307-3 6P UN-MNL AUFN-GEH</p>	 <p>TE Part # 1-480704-2 06P UMNL PLUG HSG RED</p>	 <p>TE Part # 926302-1 10& UNIV.M-N-L.PLUG</p>	 <p>TE Part # 1-350777-2 02P UMNL V0 PLUG HSG RED</p>



TE Part # 350783-1
12P UMNL CAP HSG



TE Part # 1-350778-9
02P UMNL V0 CAP HSG BLACK



TE Part # 350735-1
12P UMNL PLUG HSG



TE Part # 926302-3
10P UN-MNL STECKGEH



TE Part # 926308-3
8P UN-MNL AUFN-GEH



TE Part # 350736-1
15P UMNL PLUG HSG



TE Part # 1-480701-4
03P UMNL CAP HSG YELL



TE Part # 640585-1
06P UMNL PLUG HSG V2 NATL



TE Part # 926308-1
8P UNIV.M-N-L.CAP



TE Part # 1-480703-9
04P UMNL CAP HSG BLK



TE Part # 350720-1
09P UMNL PLUG HSG



TE Part # 350810-1
05P UMNL CAP HSG

Also in the Series | **Universal MATE-N-LOK**



Circular Power Connectors(2)

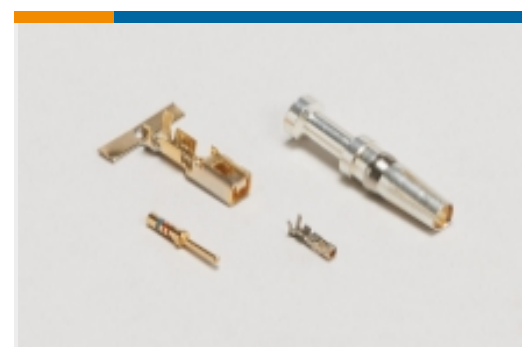

Connector Contacts(11)



Insertion & Extraction Tools(4)

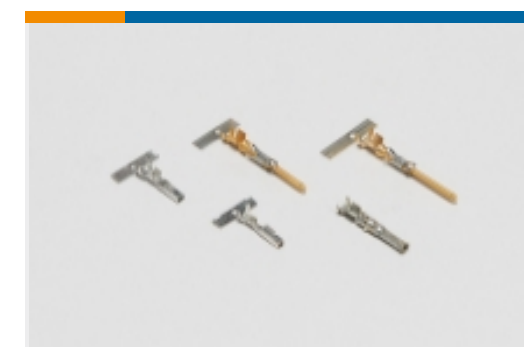

Power Contacts(207)



Rectangular Boots & Strain Relief(35)

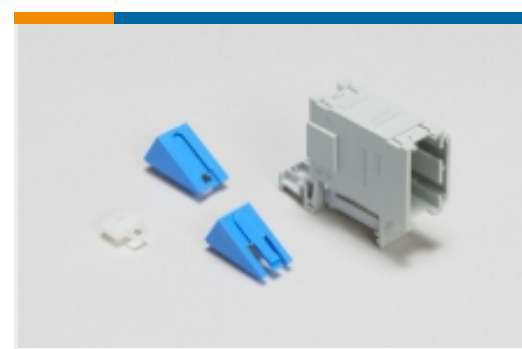

Rectangular Connector Adapters(7)



Rectangular Connector Hardware(1)



Rectangular Connector Housings(2)



Rectangular Connector Keying Plugs(3)



Rectangular Connector Locking(4)

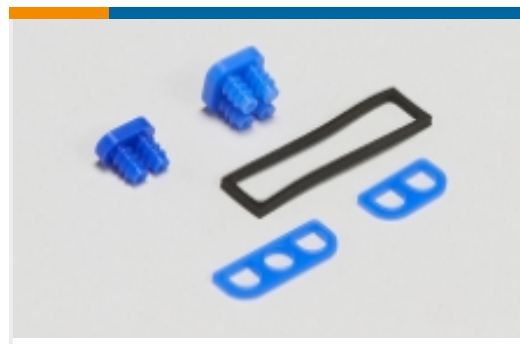

Rectangular Connector Seals(26)



Rectangular Power Connectors(729)

Customers Also Bought



TE Part #926898-1
UNIV.M-N-L.PIN



TE Part #350767-1
03P UMNL CAP HSG V0



TE Part #350780-1
04P UMNL CAP HSG



TE Part #350766-4
03P UMNL PLUG HSG UL94V0



TE Part #7-1393810-0
V23154N 721B110



TE Part #1-1614958-7
CPF 0805 1R43 0.1% 25ppm 1K RL

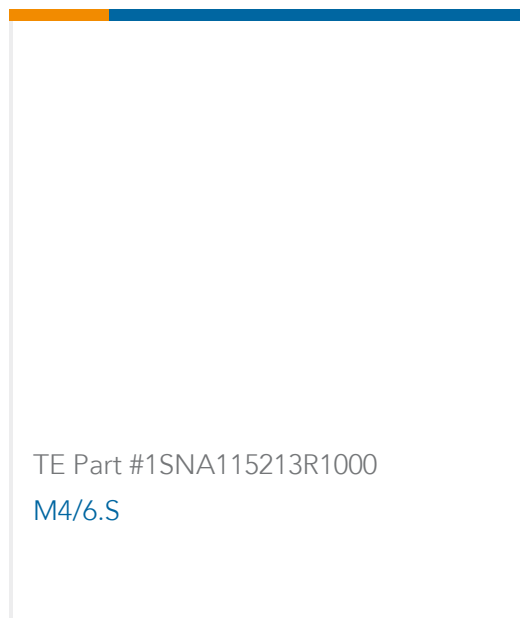

TE Part #1SNA115213R1000
M4/6.S

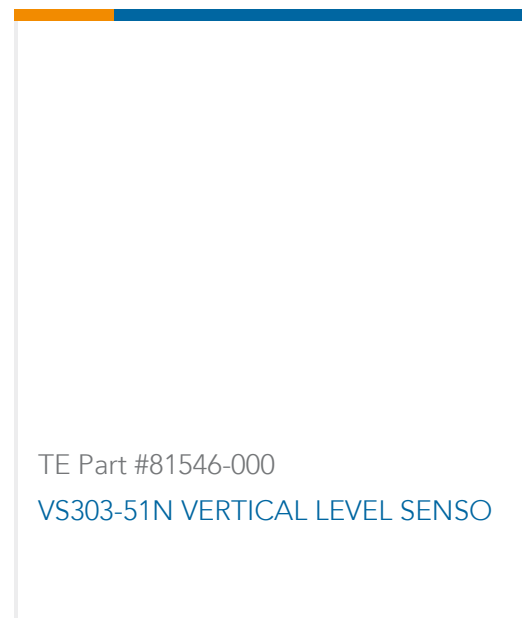

TE Part #81546-000
VS303-51N VERTICAL LEVEL SENSO

Documents

Product Drawings

[UNIV.M-N-L.SOCKET CONTACT](#)

English

CAD Files

Customer View Model

[ENG_CVM_CVM_926893-1_K.2d_dxf.zip](#)

English

3D PDF

3D

Customer View Model

[ENG_CVM_CVM_926893-1_K.3d_igs.zip](#)

English

Customer View Model

[ENG_CVM_CVM_926893-1_K.3d_stp.zip](#)

English

By downloading the CAD file I accept and agree to the [Terms and Conditions](#) of use.



Product Environmental Compliance

[MD_926893-1_092520181024_dmtec](#)

English

[MD_926893-1_092520181024_dmtec](#)

English

Agency Approvals

[VDE Certificate](#)

English