

964204-1 ✓ ACTIVE

[RAST](#) | [RAST 5 IDC Connectors](#)

TE Internal #: 964204-1

Automotive Terminals, Receptacle, Mating Tab Width 5.8 mm [.228 in], Tab Thickness .031 in [.8 mm], 16 – 12 AWG Wire Size, RAST 5 IDC Connectors

[View on TE.com >](#)



Terminals & Splices > Automotive Terminals

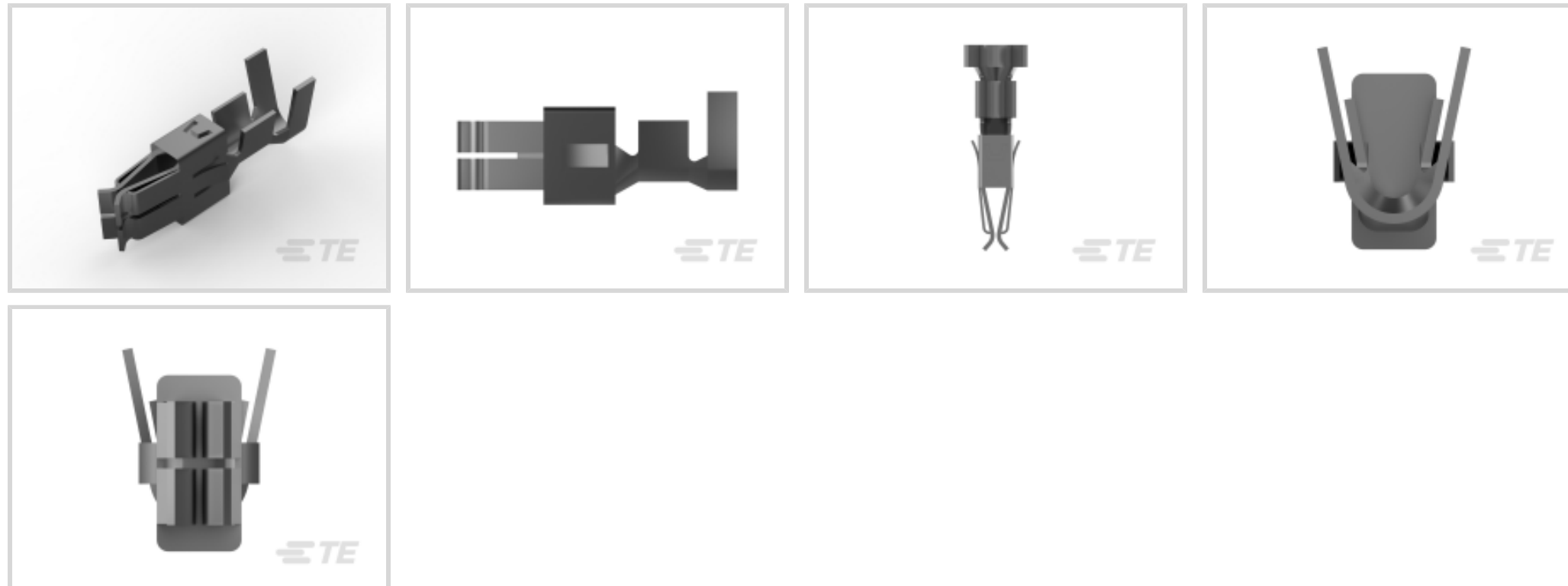

Terminal Type: **Receptacle**

Mating Tab Width: **5.8 mm [.228 in]**

Mating Tab Thickness: **.8 mm [.031 in]**

Terminal Transmits: **0 – 24 A (Low Power)**

Wire Size: **16 – 12 AWG**

## Features

### Product Type Features

Sealable	No
Primary Locking Feature	Locking Lance

### Contact Features

Contact Size	6.3mm
Contact Fabrication	Stamped & Formed
Crimp Type	F-Crimp
Terminal Type	Receptacle
Mating Tab Width	5.8 mm[.228 in]
Mating Tab Thickness	.8 mm[.031 in]
Interface Plating	Tin (Sn)

### Termination Features

Termination Method to Wire & Cable	Crimp
Product Terminates To	Wire

## Dimensions



Wire Size	1.5 – 3 mm <sup>2</sup>
Wire Size Search	12 AWG, 13 AWG, 14 AWG, 15 AWG

### Usage Conditions

Insulation Option	Uninsulated
Operating Temperature (Max)	80 °C, 85 °C, 90 °C, 100 °C, 105 °C, 110 °C, 120 °C, 125 °C, 130 °C[176 °F][185 °F][194 °F][212 °F][221 °F][230 °F][248 °F][257 °F][266 °F]
Operating Temperature Range	-40 – 130 °C[-40 – 266 °F]

### Operation/Application

Compatible With Wire Base Material	Copper
------------------------------------	--------

### Packaging Features

Packaging Method	Reel
Packaging Quantity	2000

### Other

Terminal Transmits	0 – 24 A (Low Power)
--------------------	----------------------

## Product Compliance

[For compliance documentation, visit the product page on TE.com>](#)

EU RoHS Directive 2011/65/EU	Compliant
EU ELV Directive 2000/53/EC	Compliant
China RoHS 2 Directive MIIT Order No 32, 2016	No Restricted Materials Above Threshold
EU REACH Regulation (EC) No. 1907/2006	Current ECHA Candidate List: JUNE 2022 (224) Candidate List Declared Against: JAN 2022 (223) SVHC > Threshold: Not Yet Reviewed
Halogen Content	Low Halogen - Br, Cl, F, I < 900 ppm per homogenous material. Also BFR/CFR/PVC Free
Solder Process Capability	Not applicable for solder process capability

#### Product Compliance Disclaimer

This information is provided based on reasonable inquiry of our suppliers and represents our current actual knowledge based on the information they provided. This information is subject to change. The part numbers that TE has identified as EU RoHS compliant have a maximum concentration of 0.1% by weight in homogenous materials for lead, hexavalent chromium, mercury, PBB, PBDE, DBP, BBP, DEHP, DIBP, and 0.01% for cadmium, or qualify for an exemption to these

limits as defined in the Annexes of Directive 2011/65/EU (RoHS2). Finished electrical and electronic equipment products will be CE marked as required by Directive 2011/65/EU. Components may not be CE marked. Additionally, the part numbers that TE has identified as EU ELV compliant have a maximum concentration of 0.1% by weight in homogenous materials for lead, hexavalent chromium, and mercury, and 0.01% for cadmium, or qualify for an exemption to these limits as defined in the Annexes of Directive 2000/53/EC (ELV). Regarding the REACH Regulation, the information TE provides on SVHC in articles for this part number is based on the latest European Chemicals Agency (ECHA) 'Guidance on requirements for substances in articles' posted at this URL: <https://echa.europa.eu/guidance-documents/guidance-on-reach>

## Compatible Parts



TE Part # 4-1579007-3  
EXTRACTION TOOL KIT



TE Part # 1-1579007-6  
EXTRACTION TOOL



TE Part # CAT-M9194-CH8172  
MULTILOCK, CONNECTOR HOUSING



TE Part # CAT-T4827-CH8172  
TIMER, CONNECTOR HOUSING



TE Part # 1241959-4  
STD-TIM HSG MKII 4P



TE Part # 1-2315717-2  
STD TIMER PLUG HSG 2P MKII



TE Part # 2-2315717-2  
STD TIMER PLUG HSG 2P MKII



TE Part # 2-2836281-1  
OCEAN\_2.0\_APPLICATOR-S-110F156F



TE Part # 2-2836281-2  
OCEAN\_2.0\_APPLICATOR-S-110F156F



TE Part # 2-2836550-1  
OCEAN-2.0-APPLICATOR-S-110F155OV



TE Part # 2-2836550-2  
OCEAN-2.0-APPLICATOR-S-110F155OVA



TE Part # 2836281-1  
OCEAN\_2.0\_APPLICATOR-S-110F156F



TE Part # 2836281-2  
OCEAN\_2.0\_APPLICATOR-S-110F156F



TE Part # 2836550-1  
OCEAN-2.0-APPLICATOR-S-110F155OV



TE Part # 2836550-2  
OCEAN-2.0-APPLICATOR-S-110F155OVA

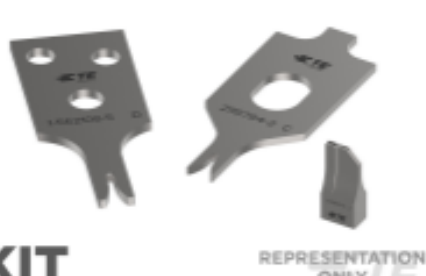

KIT  
REPRESENTATION ONLY

TE Part # 7-2836281-7  
OCEAN\_2.0\_SPARE\_PART\_KIT-110F156F



TE Part # 7-2836550-1  
OCEAN-2.0-APPLICATOR-S-110F155OV



TE Part # 7-2836550-2  
OCEAN-2.0-APPLICATOR-S-110F155OVA



TE Part # 7-2836550-7  
OCEAN\_2.0\_SPARE\_PART\_KIT-110F155OV



TE Part # 368454-8  
090/250 HYB 16P PLUG ASSY BLU

## Also in the Series | RAST 5 IDC Connectors



Automotive Terminals(8)



Connector Contacts(12)



Crimp Terminal Housings(41)



Insertion & Extraction Tools(1)



PCB Headers & Receptacles(424)



Rectangular Connector Housings(1)

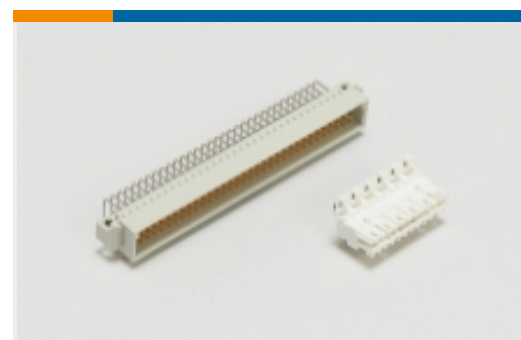

Standard Edge Connectors(47)



Standard Rectangular Connectors(112)

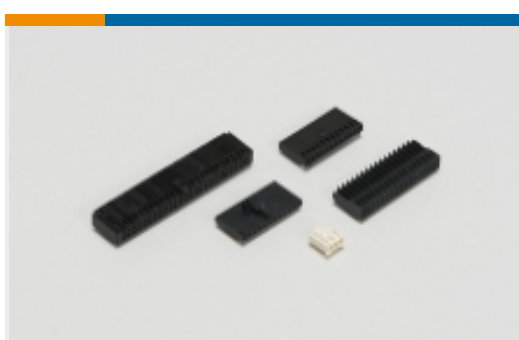

Wire-to-Board Connector Assemblies & Housings(213)



Wire-to-Board Connector Contacts(2)

## Customers Also Bought



TE Part #2-1241961-7  
STD TIM HOUSING MKII 3POS



TE Part #62194-2  
MIN AMVAR SPLC 016TPBR



TE Part #1-1241964-1  
11POS STANDARD TIMER HOUSING



TE Part #1534415-4  
DUOPL POW FEM CON4P

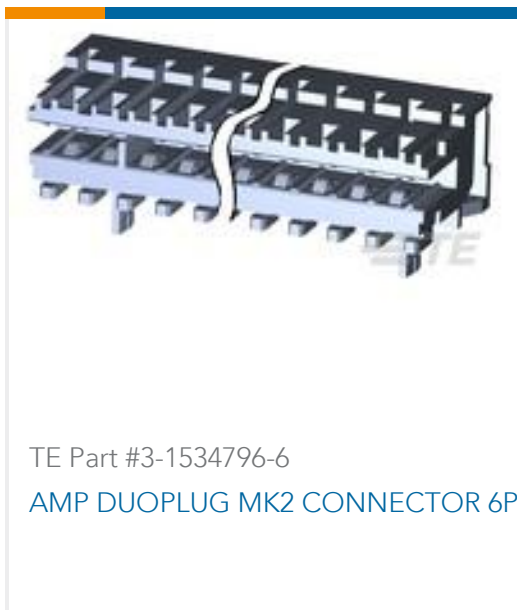

TE Part #3-1534796-6  
AMP DUOPLUG MK2 CONNECTOR 6P

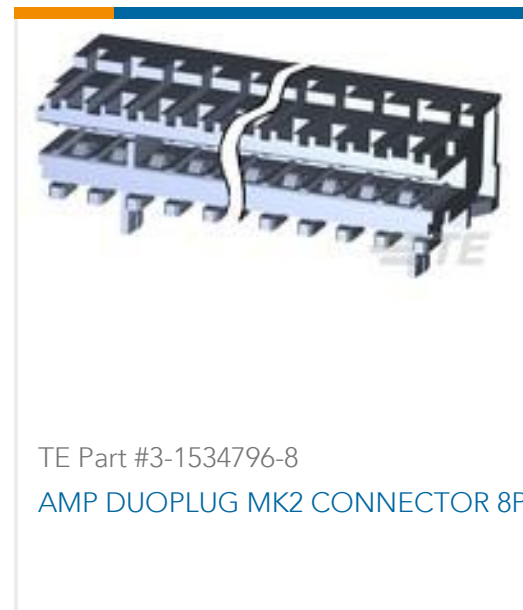

TE Part #3-1534796-8  
AMP DUOPLUG MK2 CONNECTOR 8P



TE Part #1-2232893-1  
11P MONOPLUG 2.5



TE Part #1534072-1  
MULTIFIT MK2 ASSY 1P,AR



TE Part #1534077-3  
MULTIFIT MK2ASSY 3P,IR

## Documents

### Product Drawings

STD-POW-TIM KONTAKT

English

### CAD Files

3D PDF

3D

Customer View Model

[ENG\\_CVM\\_CVM\\_964204-1\\_B.2d\\_dxf.zip](#)

English

Customer View Model

[ENG\\_CVM\\_CVM\\_964204-1\\_B.3d\\_igs.zip](#)

English

Customer View Model

[ENG\\_CVM\\_CVM\\_964204-1\\_B.3d\\_stp.zip](#)

English

3D PDF

English

Customer View Model

[ENG\\_CVM\\_964204-1\\_B1.2d\\_dxf.zip](#)

English

Customer View Model

[ENG\\_CVM\\_964204-1\\_B1.3d\\_igs.zip](#)

English

Customer View Model

[ENG\\_CVM\\_964204-1\\_B1.3d\\_stp.zip](#)

English



By downloading the CAD file I accept and agree to the [Terms and Conditions](#) of use.

---

### Datasheets & Catalog Pages

[1654742\\_HOUSEHOLD\\_APPLIANCES\\_RAST5](#)

English

---

### Product Specifications

[Application Specification](#)

English

---

### Product Environmental Compliance

[MD\\_964204-1\\_06282017113\\_dmtec](#)

English

[MD\\_964204-1\\_06282017113\\_dmtec](#)

English