

936142-1 ✓ ACTIVE

Junior Power Timer

TE Internal #: 936142-1

TE Internal Description: JPT SEALED PLUG 6P ASSY(UEGO)

TIMER, CONNECTOR HOUSING

[View on TE.com >](#)



All TIMER, CONNECTOR HOUSING (543)

Product Compliance

[For compliance documentation, visit the product page on TE.com>](#)

EU RoHS Directive 2011/65/EU	Compliant
EU ELV Directive 2000/53/EC	Compliant
China RoHS 2 Directive MIIT Order No 32, 2016	No Restricted Materials Above Threshold
EU REACH Regulation (EC) No. 1907/2006	Current ECHA Candidate List: JUNE 2022 (224) Candidate List Declared Against: JUNE 2022 (224) Does not contain REACH SVHC
Halogen Content	Low Halogen - Br, Cl, F, I < 900 ppm per homogenous material. Also BFR/CFR/PVC Free
Solder Process Capability	Not applicable for solder process capability

Product Compliance Disclaimer

This information is provided based on reasonable inquiry of our suppliers and represents our current actual knowledge based on the information they provided. This information is subject to change. The part numbers that TE has identified as EU RoHS compliant have a maximum concentration of 0.1% by weight in homogenous materials for lead, hexavalent chromium, mercury, PBB, PBDE, DBP, BBP, DEHP, DIBP, and 0.01% for cadmium, or qualify for an exemption to these limits as defined in the Annexes of Directive 2011/65/EU (RoHS2). Finished electrical and electronic equipment products will be CE marked as required by Directive 2011/65/EU. Components may not be CE marked. Additionally, the part numbers that TE has identified as EU ELV compliant have a maximum concentration of 0.1% by weight in homogenous materials for lead, hexavalent chromium, and mercury, and 0.01% for cadmium, or qualify for an exemption to these limits as defined in the Annexes of Directive 2000/53/EC (ELV). Regarding the REACH Regulation, the information TE provides on SVHC in articles for this part number is based on the latest European Chemicals Agency (ECHA) 'Guidance on requirements for substances in articles' posted at this URL: <https://echa.europa.eu/guidance-documents/guidance-on-reach>

Compatible Parts



TE Part # 963294-1
SINGLE WIRE SEAL INSULATION DI



TE Part # 2-964286-1
JPT A REC 2.8 Contact SWS Au



TE Part # 368373-1
CLIP FOR EJ MK-II (TREE TYPE)



TE Part # 85229-2
CLIP HSG FOR 070 (EJ MK-II)

Also in the Series | Junior Power Timer



Automotive Connector Caps & Covers
(5)



Automotive Housings(225)



Automotive Seals & Cavity Plugs(10)



Automotive Terminals(82)



Busbars & Terminals(1)



Insertion & Extraction Tools(9)



Module Components(6)



Other Automotive Connector
Accessories(1)



PCB Headers & Receptacles(1)

Customers Also Bought



TE Part #827551-3
JUNIOR TIMER CONNECTOR-HSG



TE Part #3-1437290-8
SUPERSEAL Connector Housings: 1.0 mm

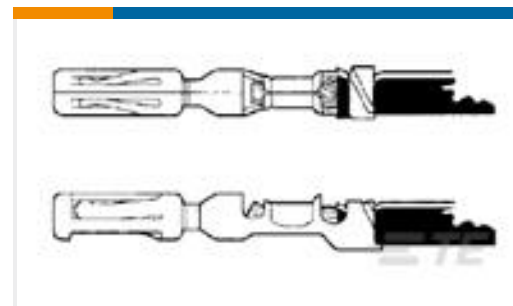

TE Part #770854-1
CONTACT, AMPSEAL SN/LP



TE Part #2822393-1
070 ECONOSEAL MARK-2+ PLUG 8P

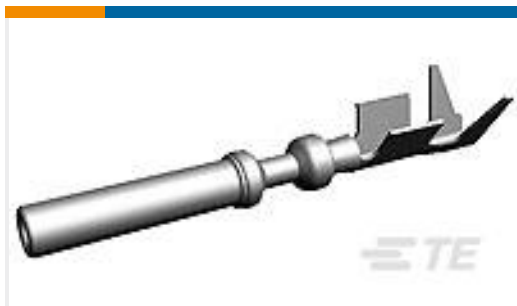

TE Part #3-1447221-4
S/S CONN REC CONTACT ASSEMBLY



TE Part #964284-2
JPT A REC 2.8 Contact SRC Sn

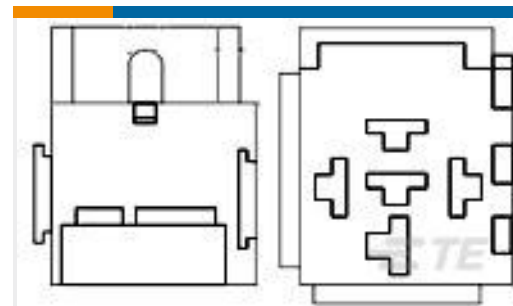

TE Part #4-1419106-0
VCF4-1002=CONNECTOR,HOUSING-

Documents

Product Drawings

JPT SEALED PLUG 6P ASSY(UEGO)

English

CAD Files

3D PDF

3D

Customer View Model

[ENG_CVM_CVM_936142-1_A.2d_dxf.zip](#)

English

Customer View Model

[ENG_CVM_CVM_936142-1_A.3d_igs.zip](#)

English

Customer View Model

[ENG_CVM_CVM_936142-1_A.3d_stp.zip](#)

English

By downloading the CAD file I accept and agree to the [Terms and Conditions](#) of use.

Datasheets & Catalog Pages

Timer Interconnection System

English

Product Specifications

Product Specification

English