



MATE-N-LOK | Commercial MATE-N-LOK

TE Internal #: 927843-2

Power Contacts, Contact, 250 VAC, Pre-Tin, 20 – 17 AWG Wire Size, .52 – 1.04 mm² Wire Size, Wire-to-Wire, Wire & Cable, Crimp, Commercial MATE-N-LOK

[View on TE.com >](#)

Connectors > Power Connectors > Power Contacts

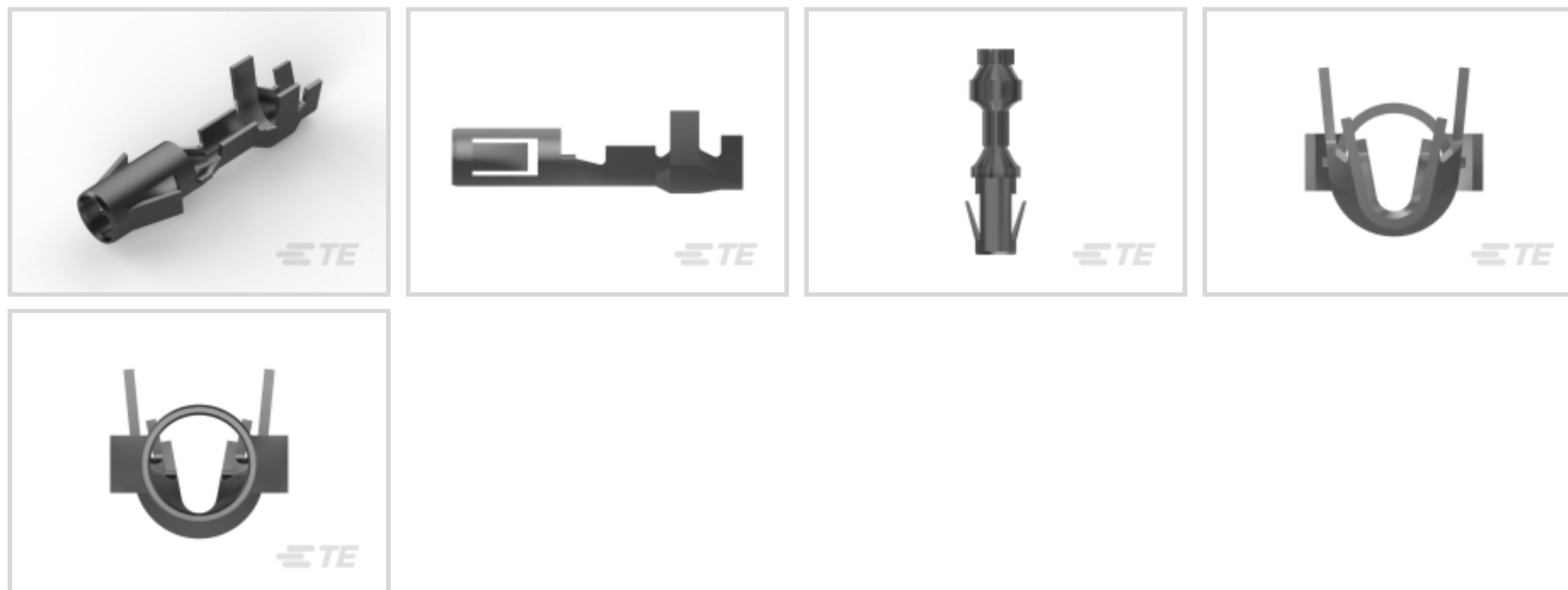

Power Contact Type: **Contact**

Operating Voltage: **250 VAC**

Contact Mating Area Plating Material: **Pre-Tin**

Wire Size: **.52 – 1.04 mm²**

Features

Product Type Features

Power Contact Type	Contact
Connector System	Wire-to-Wire
Connector & Contact Terminates To	Wire & Cable

Electrical Characteristics

Operating Voltage	250 VAC
-------------------	---------

Contact Features

Contact Mating Area Plating Material	Pre-Tin
Contact Current Rating (Max)	17 A
Contact Type	Socket
Contact Retention Within Housing	With
Mating Pin Diameter	3.56 mm[.14 in]
Contact Base Material	Phosphor Bronze
Wire Contact Termination Area Plating Thickness	.8 – 2 μm[31.5 – 78.74 μin]
Wire Contact Termination Area Plating Material	Pre-Tin
Wire Contact Termination Area Plating Material Finish	Bright



Contact Orientation	Straight
---------------------	----------

Termination Features

Termination Method to Wire & Cable	Crimp
------------------------------------	-------

Mechanical Attachment

Contact Retention Type Within Housing	Locking Lance
---------------------------------------	---------------

Connector Mounting Type	Cable Mount (Free-Hanging)
-------------------------	----------------------------

Wire Insulation Support	With
-------------------------	------

Dimensions

Wire Size	.52 – 1.04 mm ²
-----------	----------------------------

Accepts Wire Insulation Diameter Range	1.4 – 2.3 mm [.055 – .09 in]
--	------------------------------

Overall Length	20 mm [.787 in]
----------------	-----------------

Usage Conditions

Operating Temperature Range	-55 – 105 °C [-67 – 221 °F]
-----------------------------	-----------------------------

Operation/Application

Circuit Application	Power
---------------------	-------

Industry Standards

Glow Wire Rating	Standard Part - Not Glow Wire
------------------	-------------------------------

Packaging Features

Packaging Method	Reel
------------------	------

Packaging Quantity	2500
--------------------	------

Other

Wire/Cable Type	Discrete Wire
-----------------	---------------

Product Compliance

[For compliance documentation, visit the product page on TE.com>](#)

EU RoHS Directive 2011/65/EU	Compliant
------------------------------	-----------

EU ELV Directive 2000/53/EC	Compliant
-----------------------------	-----------

China RoHS 2 Directive MIIT Order No 32, 2016	No Restricted Materials Above Threshold
---	---

EU REACH Regulation (EC) No. 1907/2006	Current ECHA Candidate List: JUNE 2022 (224) Candidate List Declared Against: JAN 2022 (223) SVHC > Threshold:
--	--



Not Yet Reviewed

Halogen Content

Low Halogen - Br, Cl, F, I < 900 ppm per homogenous material. Also BFR/CFR/PVC Free

Solder Process Capability

Not applicable for solder process capability

Product Compliance Disclaimer

This information is provided based on reasonable inquiry of our suppliers and represents our current actual knowledge based on the information they provided. This information is subject to change. The part numbers that TE has identified as EU RoHS compliant have a maximum concentration of 0.1% by weight in homogenous materials for lead, hexavalent chromium, mercury, PBB, PBDE, DBP, BBP, DEHP, DIBP, and 0.01% for cadmium, or qualify for an exemption to these limits as defined in the Annexes of Directive 2011/65/EU (RoHS2). Finished electrical and electronic equipment products will be CE marked as required by Directive 2011/65/EU. Components may not be CE marked. Additionally, the part numbers that TE has identified as EU ELV compliant have a maximum concentration of 0.1% by weight in homogenous materials for lead, hexavalent chromium, and mercury, and 0.01% for cadmium, or qualify for an exemption to these limits as defined in the Annexes of Directive 2000/53/EC (ELV). Regarding the REACH Regulation, the information TE provides on SVHC in articles for this part number is based on the latest European Chemicals Agency (ECHA) 'Guidance on requirements for substances in articles' posted at this URL: <https://echa.europa.eu/guidance-documents/guidance-on-reach>

Compatible Parts



TE Part # 1-480585-0
09P .140 MNL PLUG NAT



TE Part # 1-350346-0
03P .140 MNL PLUG P/M NAT



TE Part # 1-480672-0
09P .140 MNL PLUG PM NAT



TE Part # 1-350344-0
02P .140 MNL PLUG NAT



TE Part # 1-480510-0
04P .140 MNL PLUG NAT



TE Part # 539764-1
EXTRACTION TOOL



TE Part # 880124
9 CIR PLUG 140DIA PANEL MT NAT



TE Part # 925451-1
M-N-L SOCKET HSG



TE Part # 1-480672-9
09P .140 MNL PLUG PM BLK



TE Part # 1855490-3
HDM w/FA SMPR080F1100V G CUT



TE Part # 2-2836426-1
OCEAN_2.0_Applicator-S-080F1100V



TE Part # 2-2836426-2
OCEAN_2.0_Applicator-S-080F1100V



TE Part # 2836426-1
OCEAN_2.0_Applicator-S-080F110OV



TE Part # 2836426-2
OCEAN_2.0_Applicator-S-080F110OV



TE Part # 7-2836426-7
OCEAN_2.0_SPARE_PART_KIT-080F110OV



TE Part # 794699-1
02P .140 MNL PLUG BLK HT

Also in the Series | Commercial MATE-N-LOK

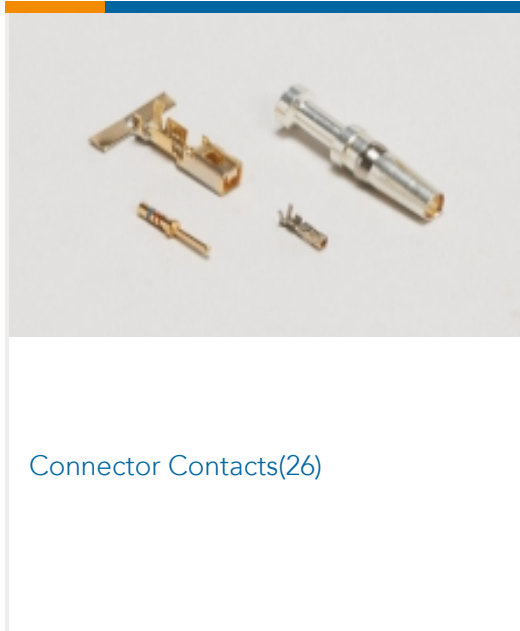

Connector Contacts(26)



Crimp Wire Pins, Tabs & Ferrules(3)

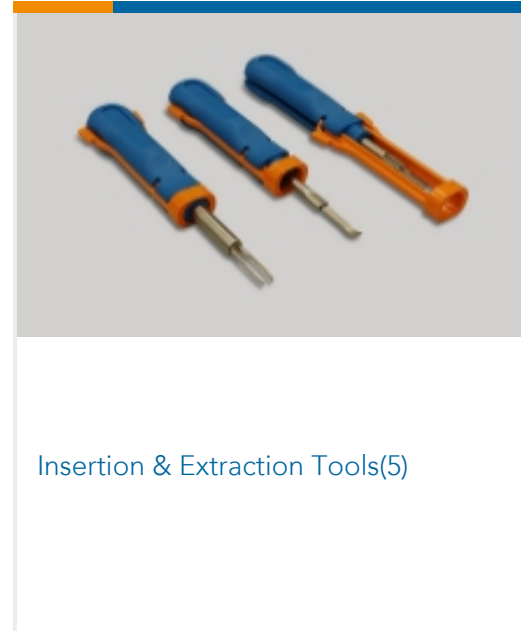

Insertion & Extraction Tools(5)

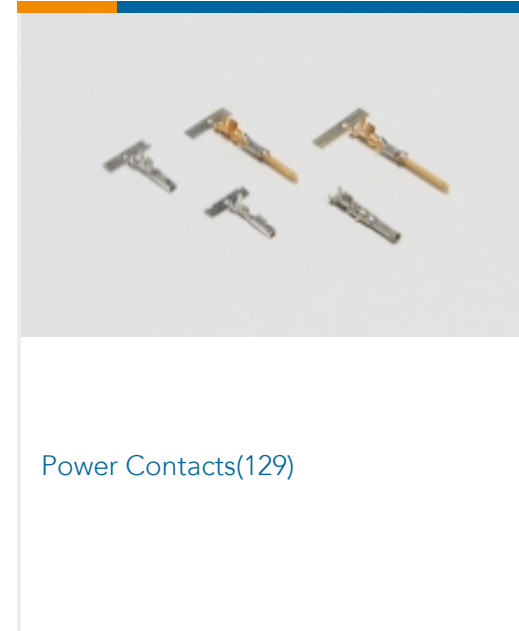

Power Contacts(129)

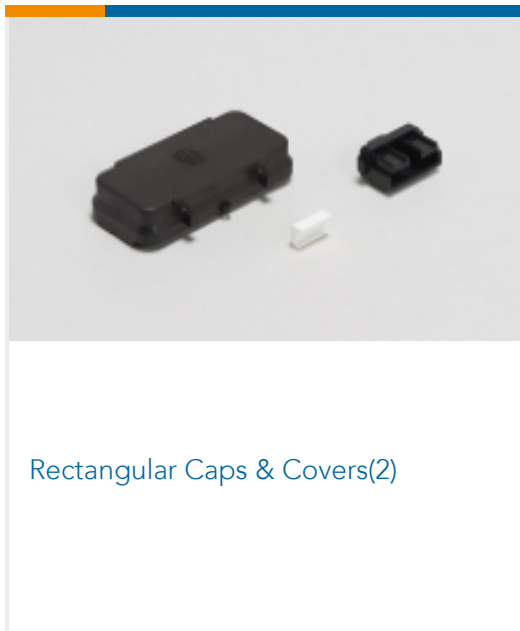

Rectangular Caps & Covers(2)

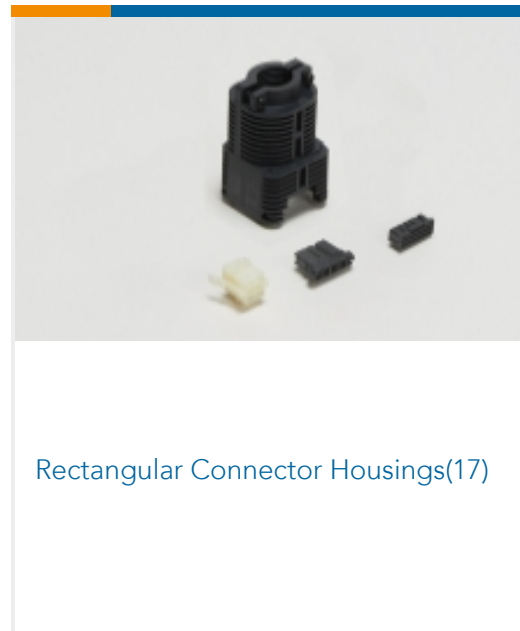

Rectangular Connector Housings(17)

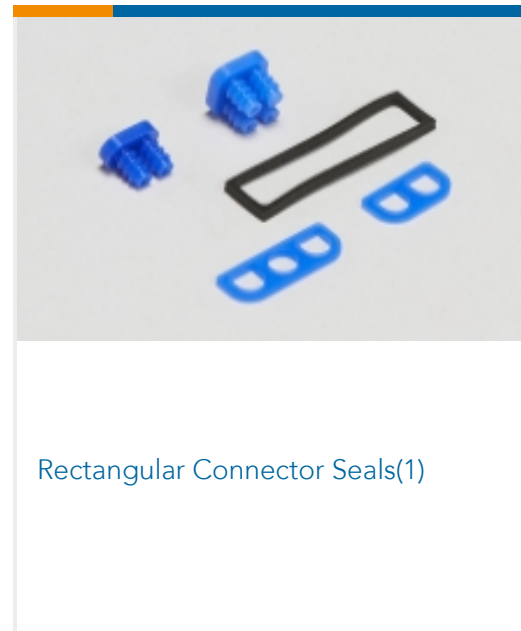

Rectangular Connector Seals(1)

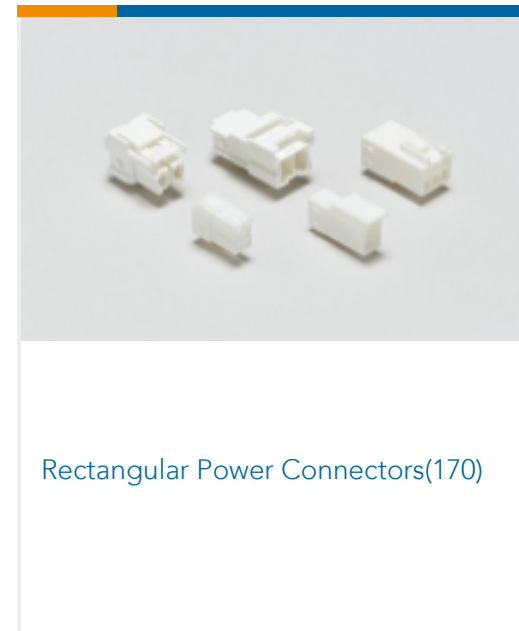

Rectangular Power Connectors(170)

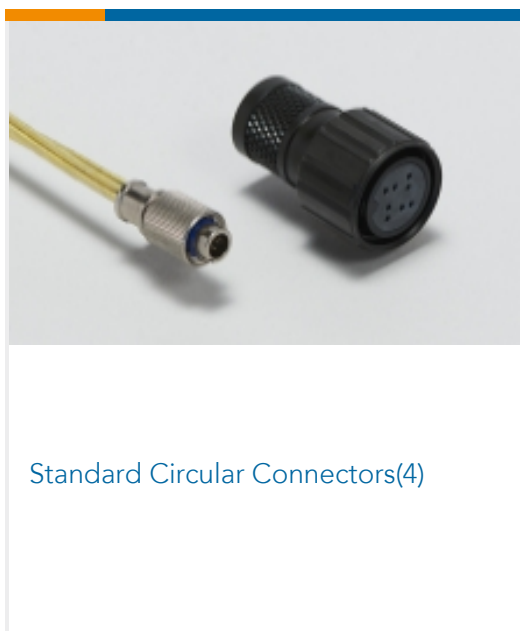

Standard Circular Connectors(4)

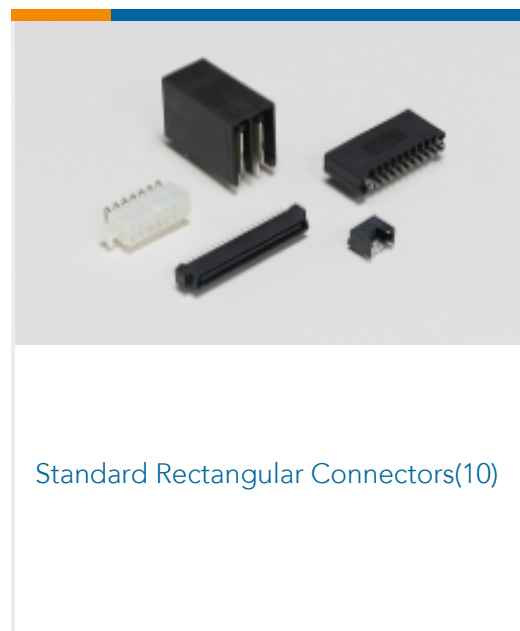

Standard Rectangular Connectors(10)

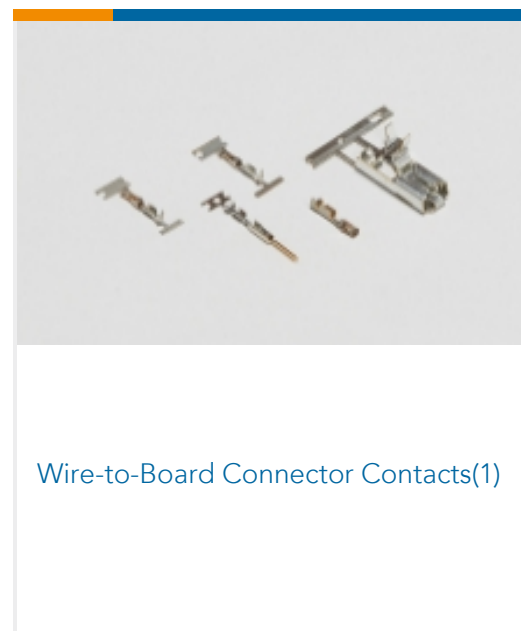

Wire-to-Board Connector Contacts(1)

Customers Also Bought



TE Part #4-1564337-1
16POS, MIXED, REC HSG, ASSY



TE Part #180351-5
FF 250 REC 4-6MM2 TPPB



TE Part #1-1718492-1
AMP MCP, UNSEALED CONNECTOR HOUSING

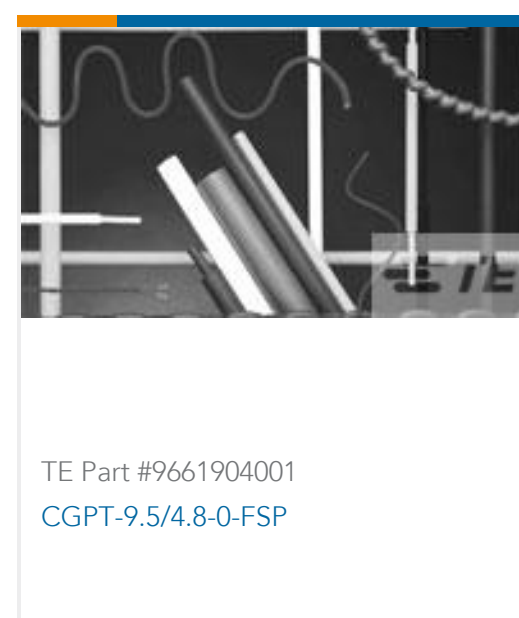

TE Part #9661904001
CGPT-9.5/4.8-0-FSP

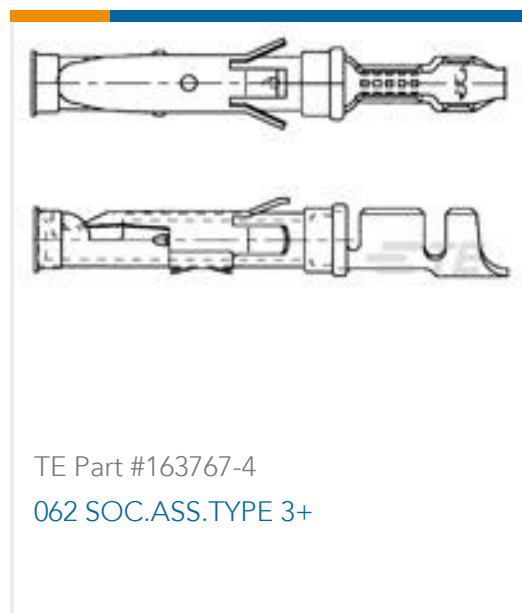
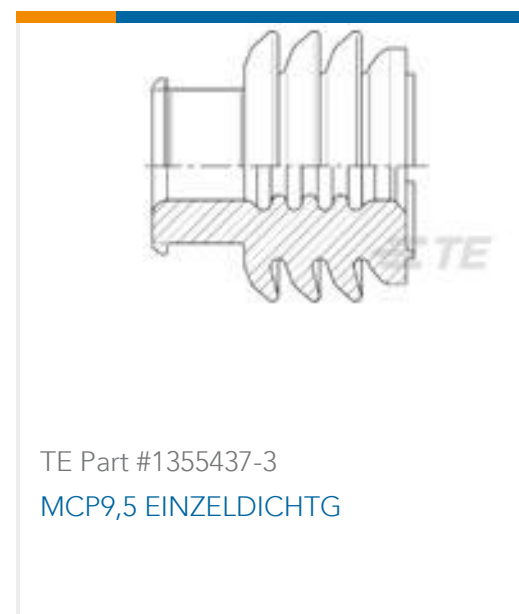

Documents

Product Drawings

[.140 SOCKET](#)

English

CAD Files

[3D PDF](#)

English

Customer View Model

[ENG_CVM_927843-2_B.2d_dxf.zip](#)

English

Customer View Model

[ENG_CVM_927843-2_B.3d_igs.zip](#)

English

Customer View Model

[ENG_CVM_927843-2_B.3d_stp.zip](#)

English

By downloading the CAD file I accept and agree to the [Terms and Conditions](#) of use.

Product Specifications

[Application Specification](#)

English

[MATE-N-LOK .140 Diameter Pin And Socket Contacts](#)

English

[Application Specification](#)

Japanese