

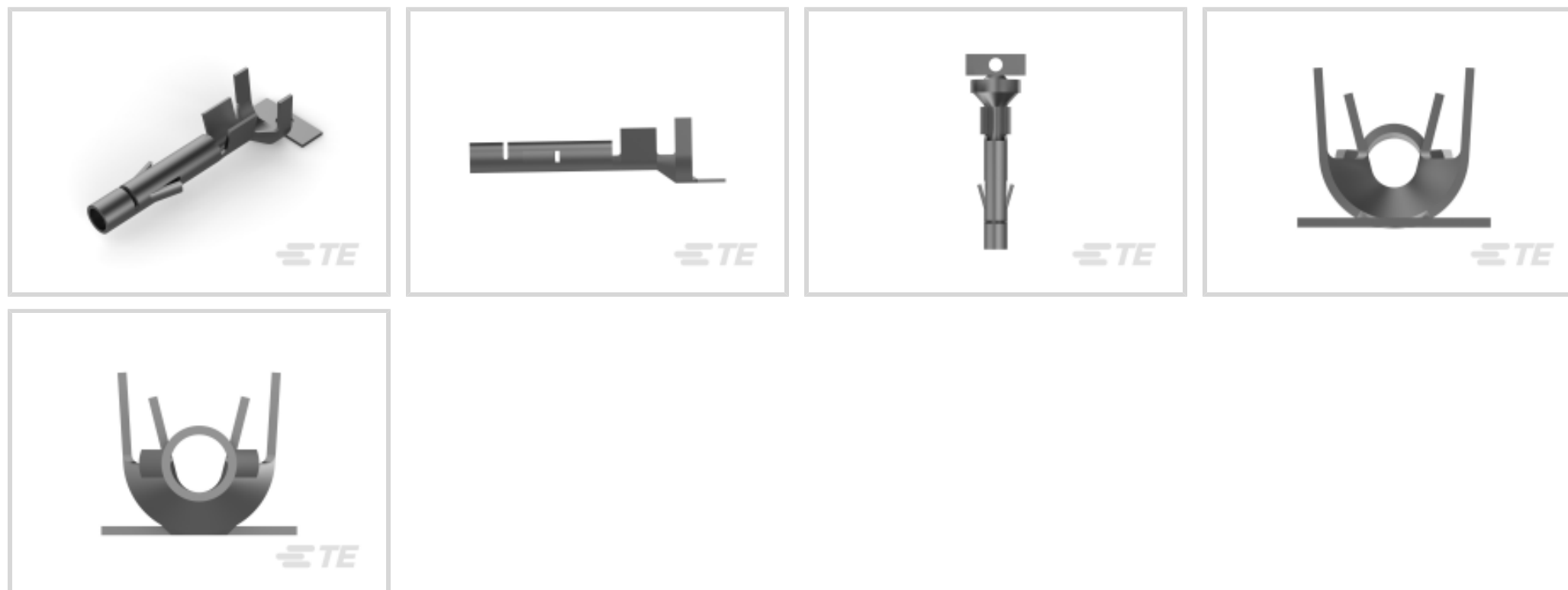

Connectors > Power Connectors > Power Contacts



Power Contact Type: **Contact**

Contact Mating Area Plating Material: **Pre-Tin**

Wire Size: **1.5 – 2.5 mm<sup>2</sup>**

Connector System: **Wire-to-Wire**

## Features

### Product Type Features

Power Contact Type	Contact
Connector System	Wire-to-Wire
Connector & Contact Terminates To	Wire & Cable

### Contact Features

Contact Mating Area Plating Material	Pre-Tin
Contact Type	Socket
Contact Retention Within Housing	With
Mating Pin Diameter	2.06 mm[.081 in]
Contact Base Material	Brass
Wire Contact Termination Area Plating Material	Tin
Wire Contact Termination Area Plating Material Finish	Bright
Contact Orientation	Straight

### Termination Features

Termination Method to Wire & Cable	Crimp
------------------------------------	-------



### Mechanical Attachment

Contact Retention Type Within Housing	Locking Lance
Connector Mounting Type	Cable Mount (Free-Hanging)
Wire Insulation Support	Without

### Dimensions

Wire Size	1.5 – 2.5 mm <sup>2</sup>
Accepts Wire Insulation Diameter Range	3.3 – 5.08 mm [.13 – .2 in]

### Operation/Application

Circuit Application	Power
---------------------	-------

### Industry Standards

CSA Rating	Certified
Glow Wire Rating	Standard Part - Not Glow Wire
VDE Tested	Yes
Agency/Standard	CSA, UL
CSA File Number	LR 7189
UL Rating	Recognized
UL File Number	E28476

### Packaging Features

Packaging Method	Reel
Packaging Quantity	2500

### Other

Wire/Cable Type	Discrete Wire
Wire Type	Stranded
For Use With	Universal MATE-N-LOK Plug or Cap Housing

### Product Compliance

[For compliance documentation, visit the product page on TE.com>](#)

EU RoHS Directive 2011/65/EU	Compliant
EU ELV Directive 2000/53/EC	Compliant
China RoHS 2 Directive MIIT Order No 32, 2016	No Restricted Materials Above Threshold
EU REACH Regulation (EC) No. 1907/2006	Current ECHA Candidate List: JUNE 2022 (224)



Candidate List Declared Against: JAN 2022  
(223)  
SVHC > Threshold:  
Not Yet Reviewed

Halogen Content  
Low Halogen - Br, Cl, F, I < 900 ppm per homogenous material. Also BFR/CFR/PVC Free

Solder Process Capability  
Not applicable for solder process capability

Product Compliance Disclaimer

This information is provided based on reasonable inquiry of our suppliers and represents our current actual knowledge based on the information they provided. This information is subject to change. The part numbers that TE has identified as EU RoHS compliant have a maximum concentration of 0.1% by weight in homogenous materials for lead, hexavalent chromium, mercury, PBB, PBDE, DBP, BBP, DEHP, DIBP, and 0.01% for cadmium, or qualify for an exemption to these limits as defined in the Annexes of Directive 2011/65/EU (RoHS2). Finished electrical and electronic equipment products will be CE marked as required by Directive 2011/65/EU. Components may not be CE marked. Additionally, the part numbers that TE has identified as EU ELV compliant have a maximum concentration of 0.1% by weight in homogenous materials for lead, hexavalent chromium, and mercury, and 0.01% for cadmium, or qualify for an exemption to these limits as defined in the Annexes of Directive 2000/53/EC (ELV). Regarding the REACH Regulation, the information TE provides on SVHC in articles for this part number is based on the latest European Chemicals Agency (ECHA) 'Guidance on requirements for substances in articles' posted at this URL: <https://echa.europa.eu/guidance-documents/guidance-on-reach>

## Compatible Parts



TE Part # 539972-1  
EXTRACTION TOOL



TE Part # 455830-1  
INSERTION TOOL



TE Part # 1-480705-2  
06P UNML CAP HSG RED



TE Part # 350784-1  
15P UMNL CAP HSG



TE Part # 926307-3  
6P UN-MNL AUFN-GEH



TE Part # 1-480704-2  
06P UMNL PLUG HSG RED



TE Part # 926302-1  
10& UNIV.M-N-L-PLUG



TE Part # 1-350777-2  
02P UMNL V0 PLUG HSG RED



## Also in the Series | Universal MATE-N-LOK

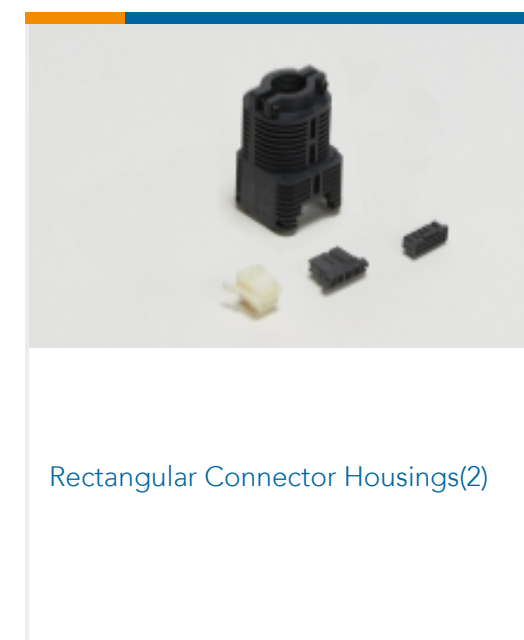
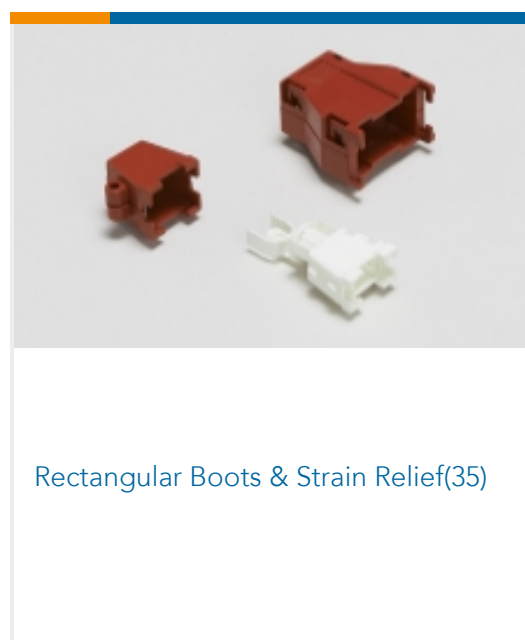
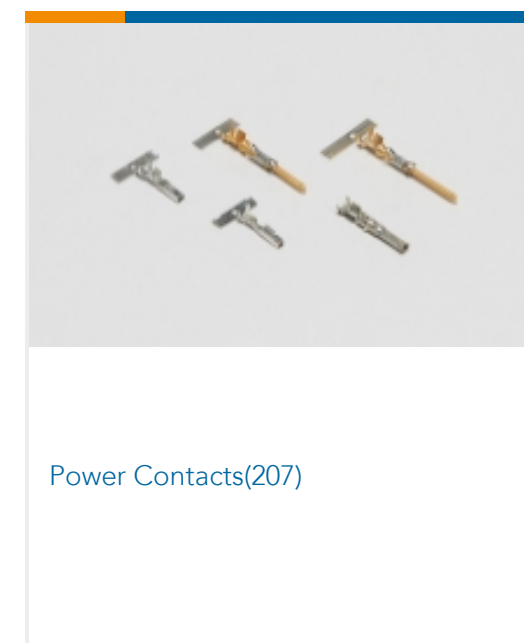
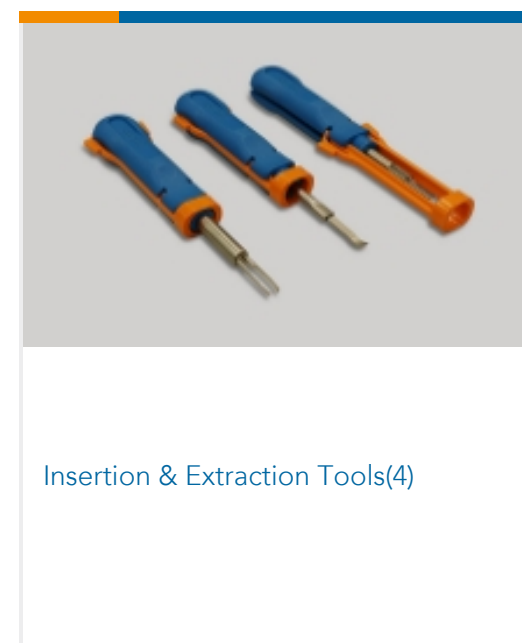
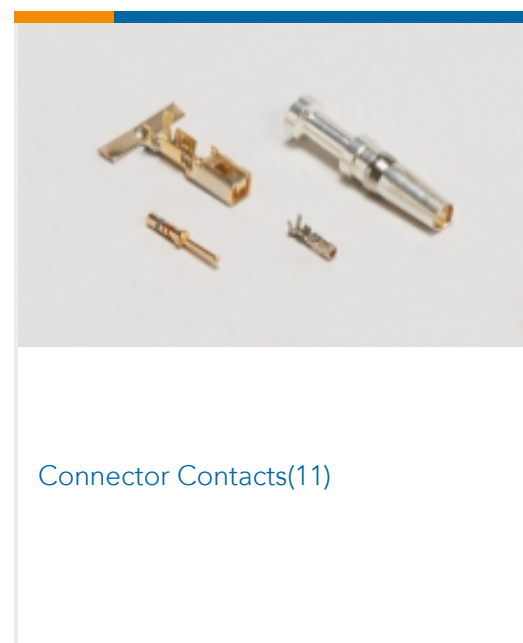
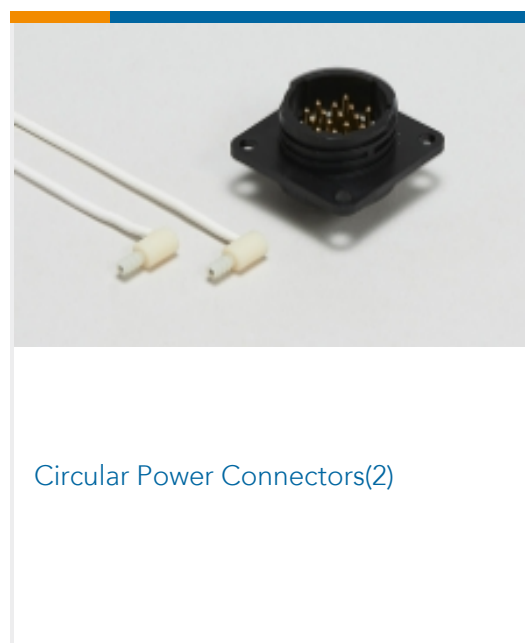

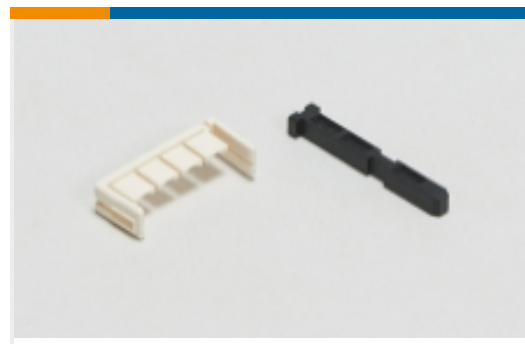

Rectangular Connector Keying Plugs(3)



Rectangular Connector Locking(4)

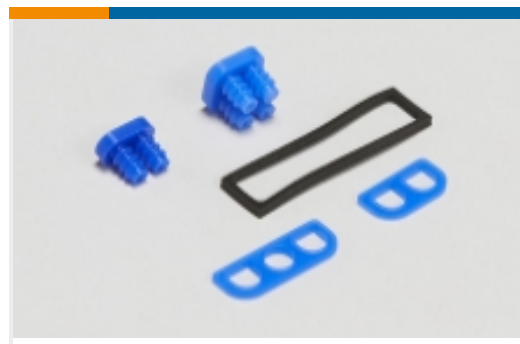

Rectangular Connector Seals(26)



Rectangular Power Connectors(729)

## Customers Also Bought



TE Part #1586845-1  
04P UMNL CAP HSG NATL, GW



TE Part #927231-5  
UNML CAP HSG 9WAY



TE Part #4-6437630-8  
FTH0904=MINIATURE TOGGLE



TE Part #EJ0064-000  
06161401



TE Part #2150007-1  
OCEAN\_2.0\_Applicator-E-090F140F



TE Part #2150334-1  
OCEAN\_2.0\_Applicator-S-090F130F



TE Part #7-2150007-7  
OCEAN\_2.0\_SPARE\_PART\_KIT-090F140F



TE Part #7-2150334-7  
OCEAN\_2.0\_SPARE\_PART\_KIT-090F130F



TE Part #7-2151372-7  
OCEAN\_2.0\_SPARE\_PART\_KIT-070F130O



TE Part #1245478-1  
HGQ8.ADP.Sti.4qmm

## Documents

### Product Drawings

[UNIV.M-N-L.SOCKET](#)

English

### CAD Files

Customer View Model

[ENG\\_CVM\\_926869-1\\_F.3d\\_igs.zip](#)

English

Customer View Model



[ENG\\_CVM\\_926869-1\\_F.3d\\_stp.zip](#)

English

**Customer View Model**

[ENG\\_CVM\\_926869-1\\_F.2d\\_dxf.zip](#)

English

**3D PDF**

English

By downloading the CAD file I accept and agree to the [Terms and Conditions](#) of use.

---

### Product Environmental Compliance

[MD\\_926869-1\\_030620182129\\_dmtec](#)

English

[MD\\_926869-1\\_030620182129\\_dmtec](#)

English

---

### Agency Approvals

[VDE Certificate](#)

English