

917975-1 ✓ ACTIVE

AMP | Multilock Connector System

TE Internal #: 917975-1

Housing for Female Terminals, Wire-to-Device / Wire-to-Board, 12 Position, .118 in [3 mm] Centerline, White, Signal, Multilock Connector System

[View on TE.com >](#)



Connectors > Automotive Connectors > Connector Housings > MULTILOCK, CONNECTOR HOUSING

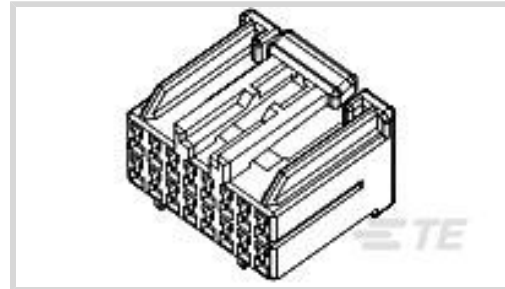

Connector & Housing Type: **Housing for Female Terminals**

Mating Tab Width: **1 mm [ .039 in ]**

Connector System: **Wire-to-Board, Wire-to-Device**

Number of Positions: **12**

Centerline (Pitch): **3 mm [ .118 in ]**

[All MULTILOCK, CONNECTOR HOUSING \(576\)](#)

## Features

### Product Type Features

Connector & Housing Shape	Rectangular
Connector & Housing Type	Housing for Female Terminals
Connector System	Wire-to-Board, Wire-to-Device
Sealable	No
Hybrid Connector	Yes
Primary Locking Feature	Integrated in Housing

### Configuration Features

Number of Positions	12
Number of Rows	2

### Electrical Characteristics

Operating Voltage	12 VDC
Nominal Voltage Architecture	12 V

### Body Features

Cable Exit Angle	180°
Body Material	PBT
Primary Product Color	White



### Contact Features

Contact Size	1.8mm, 1mm
Contact Type	Receptacle
Mating Tab Width	1 mm[.039 in]

### Mechanical Attachment

Mounting Feature	Without
Terminal Position Assurance	Yes
Strain Relief	Without
Mating Alignment Type	Polarized
Mating Alignment	With
Connector Mounting Type	Cable Mount (Free-Hanging)

### Housing Features

Centerline (Pitch)	3 mm[.118 in]
--------------------	---------------

### Dimensions

Product Width	19 mm[.748 in]
Product Length	21 mm[.827 in]
Product Height	17.3 mm[.681 in]
Row-to-Row Spacing	5.2 mm[.205 in]

### Usage Conditions

Operating Temperature (Max)	70 °C, 75 °C, 80 °C, 85 °C, 90 °C, 100 °C, 105 °C[158 °F][167 °F][176 °F][185 °F][194 °F] [212 °F][221 °F]
Operating Temperature Range	-30 – 105 °C[-22 – 221 °F]

### Operation/Application

Circuit Application	Signal
---------------------	--------

### Industry Standards

UL Flammability Rating	UL 94HB
------------------------	---------

### Packaging Features

Packaging Quantity	100
Packaging Method	Bag

### Other

Serviceable	Yes
-------------	-----



Connector Position Assurance Capable

No

### Product Compliance

[For compliance documentation, visit the product page on TE.com>](#)

EU RoHS Directive 2011/65/EU	Compliant
EU ELV Directive 2000/53/EC	Compliant
China RoHS 2 Directive MIIT Order No 32, 2016	No Restricted Materials Above Threshold
EU REACH Regulation (EC) No. 1907/2006	Current ECHA Candidate List: JUNE 2022 (224) Candidate List Declared Against: JUN 2020 (209) SVHC > Threshold: Not Yet Reviewed
Halogen Content	Low Halogen - Br, Cl, F, I < 900 ppm per homogenous material. Also BFR/CFR/PVC Free
Solder Process Capability	Not applicable for solder process capability

#### Product Compliance Disclaimer

This information is provided based on reasonable inquiry of our suppliers and represents our current actual knowledge based on the information they provided. This information is subject to change. The part numbers that TE has identified as EU RoHS compliant have a maximum concentration of 0.1% by weight in homogenous materials for lead, hexavalent chromium, mercury, PBB, PBDE, DBP, BBP, DEHP, DIBP, and 0.01% for cadmium, or qualify for an exemption to these limits as defined in the Annexes of Directive 2011/65/EU (RoHS2). Finished electrical and electronic equipment products will be CE marked as required by Directive 2011/65/EU. Components may not be CE marked. Additionally, the part numbers that TE has identified as EU ELV compliant have a maximum concentration of 0.1% by weight in homogenous materials for lead, hexavalent chromium, and mercury, and 0.01% for cadmium, or qualify for an exemption to these limits as defined in the Annexes of Directive 2000/53/EC (ELV). Regarding the REACH Regulation, the information TE provides on SVHC in articles for this part number is based on the latest European Chemicals Agency (ECHA) 'Guidance on requirements for substances in articles' posted at this URL: <https://echa.europa.eu/guidance-documents/guidance-on-reach>

### Compatible Parts

 <p>TE Part # CAT-M9194-T273 MULTILOCK, RECEPTACLE AND TAB</p>	 <p>TE Part # CAT-HPCH5372 HIGH PIN COUNT HEADER</p>	 <p>TE Part # 178780-1 040/070 HYBRID CAP ASSY 76P</p>	 <p>TE Part # 179418-2 PMC 040 REC S L/P</p>
---	--	---	---

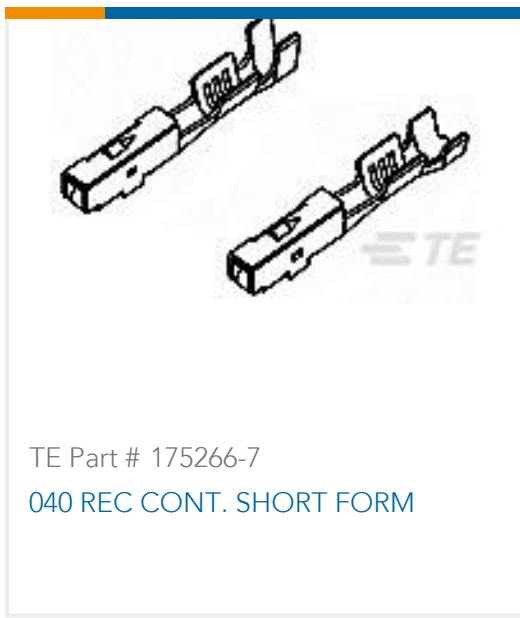

## Also in the Series | Multilock Connector System

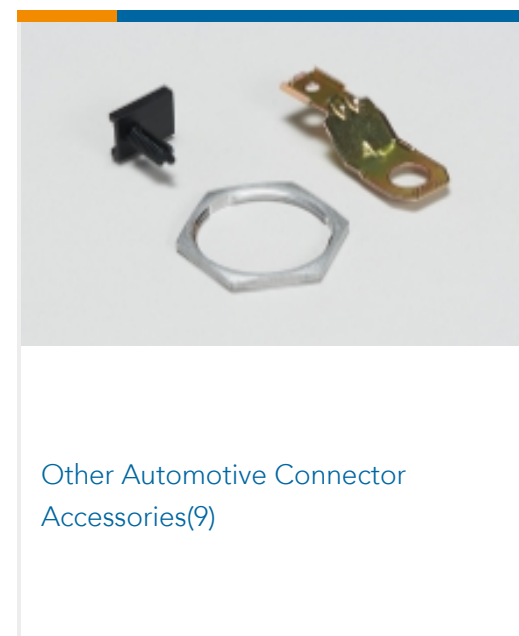
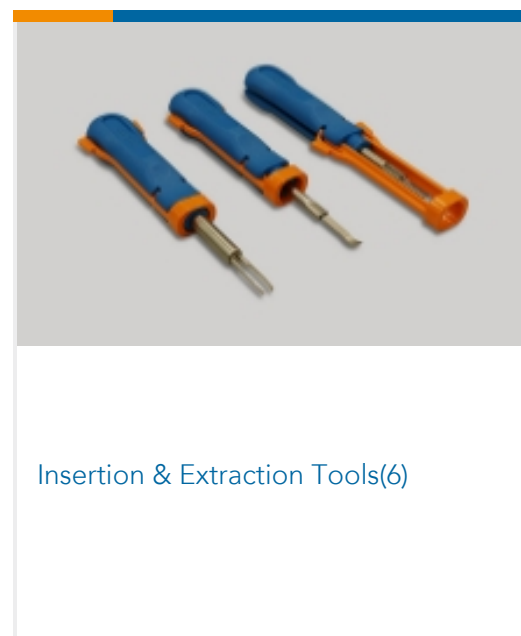
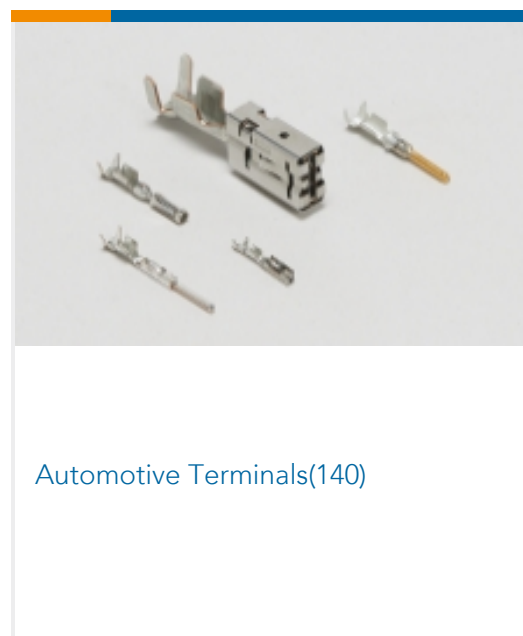
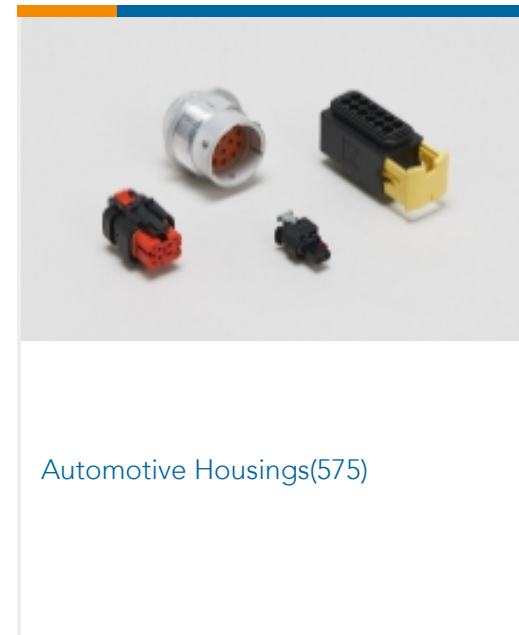
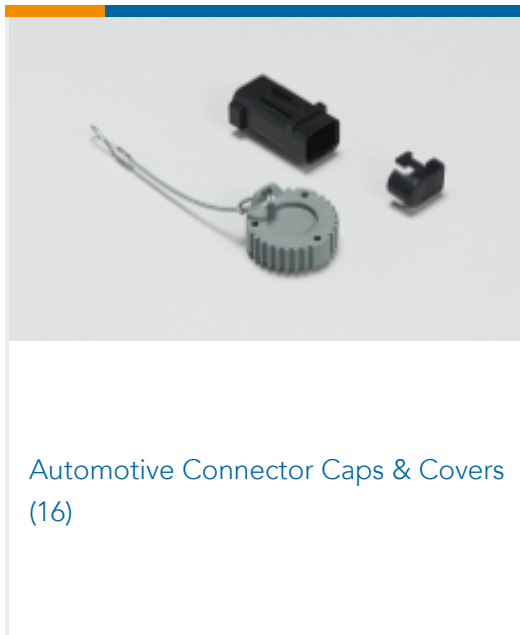

## Customers Also Bought

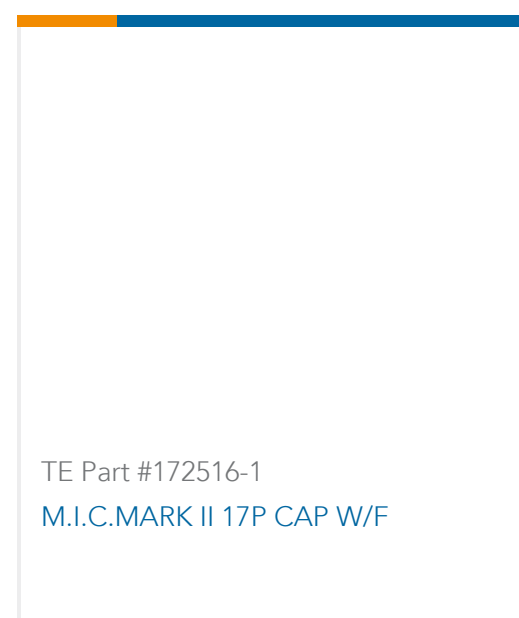

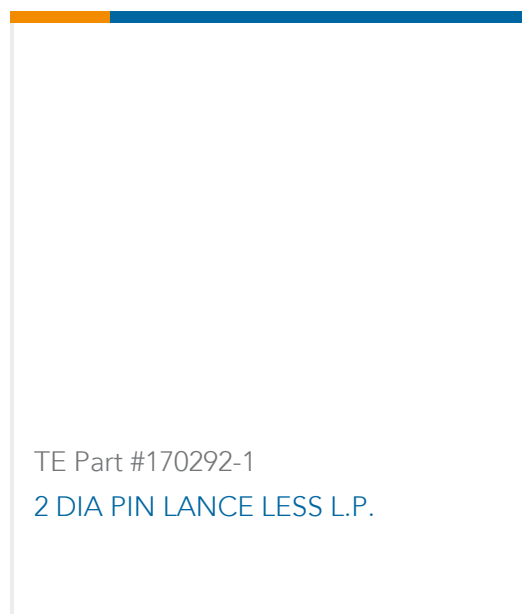

## Documents

### Product Drawings

[HYBRID MK-2 PLUG HSG ASSY 12P](#)

English

### CAD Files

[3D PDF](#)

3D

Customer View Model

[ENG\\_CVM\\_CVM\\_917975-1\\_C.2d\\_dxf.zip](#)

English

Customer View Model

[ENG\\_CVM\\_CVM\\_917975-1\\_C.3d\\_igs.zip](#)

English

Customer View Model

[ENG\\_CVM\\_CVM\\_917975-1\\_C.3d\\_stp.zip](#)

English

By downloading the CAD file I accept and agree to the [Terms and Conditions](#) of use.

### Datasheets & Catalog Pages

[MULTILOCK Connector System](#)

English

### Product Specifications

[Product Specification](#)

Japanese

### Instruction Sheets

[Instruction Sheet \(U.S.\)](#)

Japanese