



**MQS**

TE Internal #: 936121-2

Housing for Male Terminals, Wire-to-Wire, 4 Position, .1 in [2.54 mm] Centerline, Yellow, Wire & Cable, Signal, Cable Mount (Free-Hanging), MQS

[View on TE.com >](#)

Connectors > Automotive Connectors > Connector Housings > MQS, CONNECTOR HOUSING

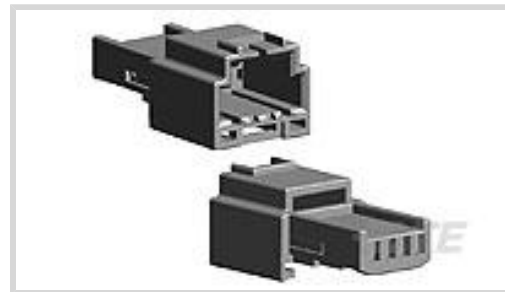

Connector & Housing Type: **Housing for Male Terminals**

Mating Tab Width: **.63 mm [ .025 in ]**

Connector System: **Wire-to-Wire**

Number of Positions: **4**

Centerline (Pitch): **2.54 mm [ .1 in ]**

[All MQS, CONNECTOR HOUSING \(557\)](#)

**Features**

**Product Type Features**

Connector & Housing Shape	Rectangular
Connector & Housing Type	Housing for Male Terminals
Connector System	Wire-to-Wire
Sealable	No
Hybrid Connector	No
Primary Locking Feature	Integrated in Housing
Connector & Contact Terminates To	Wire & Cable

**Configuration Features**

Number of Positions	4
Number of Rows	1

**Body Features**

Cable Exit Angle	180°
Body Material	PBT GF
Primary Product Color	Yellow

**Contact Features**

Contact Size	.63mm
Contact Type	Tab



Mating Tab Width	.63 mm[.025 in]
------------------	-----------------

### Mechanical Attachment

Mounting Feature	Without
Terminal Position Assurance	No
Strain Relief	Without
Mating Alignment Type	Polarized
Mating Alignment	With
Connector Mounting Type	Cable Mount (Free-Hanging)

### Housing Features

Centerline (Pitch)	2.54 mm[.1 in]
--------------------	----------------

### Dimensions

Product Width	29 mm[1.14 in]
Product Length	15 mm[.59 in]
Product Height	13.1 mm[.515 in]

### Operation/Application

Circuit Application	Signal
---------------------	--------

### Packaging Features

Packaging Quantity	400
Packaging Method	Tray

### Other

Serviceable	No
Connector Position Assurance Capable	No

### Product Compliance

[For compliance documentation, visit the product page on TE.com>](#)

EU RoHS Directive 2011/65/EU	Compliant
EU ELV Directive 2000/53/EC	Compliant
China RoHS 2 Directive MIIT Order No 32, 2016	No Restricted Materials Above Threshold
EU REACH Regulation (EC) No. 1907/2006	Current ECHA Candidate List: JUNE 2022 (224) Candidate List Declared Against: JUNE 2022 (224) Does not contain REACH SVHC

Halogen Content	Low Halogen - Br, Cl, F, I < 900 ppm per homogenous material. Also BFR/CFR/PVC Free
Solder Process Capability	Not applicable for solder process capability

Product Compliance Disclaimer

This information is provided based on reasonable inquiry of our suppliers and represents our current actual knowledge based on the information they provided. This information is subject to change. The part numbers that TE has identified as EU RoHS compliant have a maximum concentration of 0.1% by weight in homogenous materials for lead, hexavalent chromium, mercury, PBB, PBDE, DBP, BBP, DEHP, DIBP, and 0.01% for cadmium, or qualify for an exemption to these limits as defined in the Annexes of Directive 2011/65/EU (RoHS2). Finished electrical and electronic equipment products will be CE marked as required by Directive 2011/65/EU. Components may not be CE marked. Additionally, the part numbers that TE has identified as EU ELV compliant have a maximum concentration of 0.1% by weight in homogenous materials for lead, hexavalent chromium, and mercury, and 0.01% for cadmium, or qualify for an exemption to these limits as defined in the Annexes of Directive 2000/53/EC (ELV). Regarding the REACH Regulation, the information TE provides on SVHC in articles for this part number is based on the latest European Chemicals Agency (ECHA) 'Guidance on requirements for substances in articles' posted at this URL: <https://echa.europa.eu/guidance-documents/guidance-on-reach>

### Compatible Parts



TE Part # CAT-M8793-CH8172  
MQS, CONNECTOR HOUSING

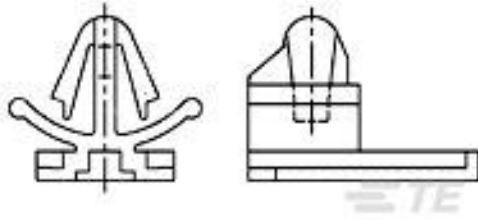

TE Part # 368165-1  
CLIP HSG FOR 070/EJ MK-II(+)



TE Part # 368373-1  
CLIP FOR EJ MK-II (TREE TYPE)

### Also in the Series | MQS



Automotive Connector Caps & Covers (132)



Automotive Connector EMC Shielding (2)



Automotive Connector Locks & Position Assurance(29)



Automotive Housings(489)



Automotive Seals & Cavity Plugs(26)

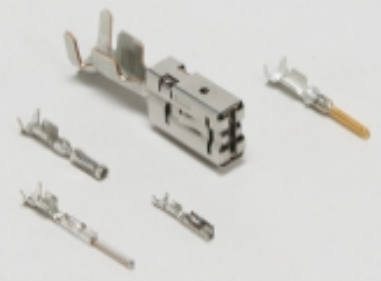

Automotive Terminals(96)



Insertion & Extraction Tools(42)



Other Automotive Connector Accessories(13)



PCB Headers & Receptacles(207)

## Customers Also Bought



TE Part #1-2292382-1  
TAB9.5X1.2 CONTACT FOR 6 QMM WIRE



TE Part #2-2287018-3  
TAB 9.5X1.2,10SQMM,AG



TE Part #2289050-2  
1 POS. PLUG ASSY, KEY A, HIGH TEMP NAT.



TE Part #9-2301629-1  
SOC CONN CVR,4POS,DIA 8MM,180 DEG

TE Part #1-1411001-1  
8POS,GET 0.64,REC HSG ASSY,SLD

TE Part #2-2203830-2  
TAB1.2X0.6,TERMINAL,SWS

TE Part #2098377-3  
20P PLUG ASSEMBLY UNSEALED HYBRID C-KEY

TE Part #2317368-2  
2P MCON 9.5 PLUG ASSEMBLY, KEY B

TE Part #6-1924513-0  
GET 40 WAY HARNESS ASSY, KEY J

TE Part #6-2035383-0  
GET PCM 70 WAY Plug ASSY Key C

## Documents

### Product Drawings

[MQS 4P CAP ASSY YELLOW](#)

English

### CAD Files

[Customer View Model](#)

[ENG\\_CVM\\_CVM\\_936121-2\\_A.2d\\_dxf.zip](#)

English

[3D PDF](#)



3D

Customer View Model

[ENG\\_CVM\\_CVM\\_936121-2\\_A.3d\\_igs.zip](#)

English

Customer View Model

[ENG\\_CVM\\_CVM\\_936121-2\\_A.3d\\_stp.zip](#)

English

By downloading the CAD file I accept and agree to the [Terms and Conditions](#) of use.

---

### Datasheets & Catalog Pages

[Micro Quadlok Interconnection System \(MQS\)](#)

English

---

### Product Specifications

[Product Specification](#)

English

---

### Product Environmental Compliance

[Product Compliance](#)

English

[Product Compliance](#)

English