

929674-1 ✓ ACTIVE

AMP | Timer Connector System

TE Internal #: 929674-1

Automotive Connector Caps & Covers, Cover - Cable Exit, Cable Exit Angle 90° (Right Angle), Black, PA, Timer Connector System

[View on TE.com >](#)



Connectors > Automotive Connectors > Connector Accessories > Connector Caps & Covers

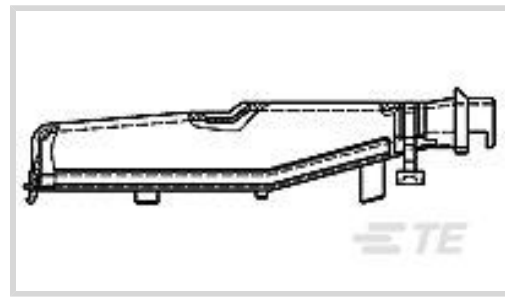

Protection & Strain Relief Accessory Type: **Cover - Cable Exit**

Cable Exit Angle: **90° (Right Angle)**

Strain Relief: **With**

Primary Product Color: **Black**

Primary Product Material: **PA**

Features

Product Type Features

Protection & Strain Relief Accessory Type	Cover - Cable Exit
Connector System	Wire-to-Board, Wire-to-Device

Configuration Features

Number of Positions	55
---------------------	----

Body Features

Cable Exit Angle	90° (Right Angle)
Primary Product Color	Black
Primary Product Material	PA

Mechanical Attachment

Strain Relief	With
---------------	------

Dimensions

Compatible Cable Bundle Diameter Range	12.9 mm[.508 in]
--	------------------

Usage Conditions

Operating Temperature (Max)	70 °C, 75 °C, 80 °C, 85 °C, 90 °C, 100 °C, 105 °C, 110 °C, 120 °C[158 °F][167 °F][176 °F][185 °F][194 °F][212 °F][221 °F][230 °F][248 °F]
Operating Temperature Range	-40 – 120 °C[-40 – 248 °F]

Industry Standards



UL Flammability Rating	UL 94HB
------------------------	---------

Packaging Features

Packaging Method	Carton
------------------	--------

Other

Serviceable	Yes
-------------	-----

Product Compliance

[For compliance documentation, visit the product page on TE.com>](#)

EU RoHS Directive 2011/65/EU	Compliant
------------------------------	-----------

EU ELV Directive 2000/53/EC	Compliant
-----------------------------	-----------

China RoHS 2 Directive MIIT Order No 32, 2016	No Restricted Materials Above Threshold
---	---

EU REACH Regulation (EC) No. 1907/2006	Current ECHA Candidate List: JUNE 2022 (224) Candidate List Declared Against: JUNE 2022 (224) Does not contain REACH SVHC
--	---

Halogen Content	Low Halogen - Br, Cl, F, I < 900 ppm per homogenous material. Also BFR/CFR/PVC Free
-----------------	---

Solder Process Capability	Not applicable for solder process capability
---------------------------	--

Product Compliance Disclaimer

This information is provided based on reasonable inquiry of our suppliers and represents our current actual knowledge based on the information they provided. This information is subject to change. The part numbers that TE has identified as EU RoHS compliant have a maximum concentration of 0.1% by weight in homogenous materials for lead, hexavalent chromium, mercury, PBB, PBDE, DBP, BBP, DEHP, DIBP, and 0.01% for cadmium, or qualify for an exemption to these limits as defined in the Annexes of Directive 2011/65/EU (RoHS2). Finished electrical and electronic equipment products will be CE marked as required by Directive 2011/65/EU. Components may not be CE marked. Additionally, the part numbers that TE has identified as EU ELV compliant have a maximum concentration of 0.1% by weight in homogenous materials for lead, hexavalent chromium, and mercury, and 0.01% for cadmium, or qualify for an exemption to these limits as defined in the Annexes of Directive 2000/53/EC (ELV). Regarding the REACH Regulation, the information TE provides on SVHC in articles for this part number is based on the latest European Chemicals Agency (ECHA) 'Guidance on requirements for substances in articles' posted at this URL: <https://echa.europa.eu/guidance-documents/guidance-on-reach>

Compatible Parts

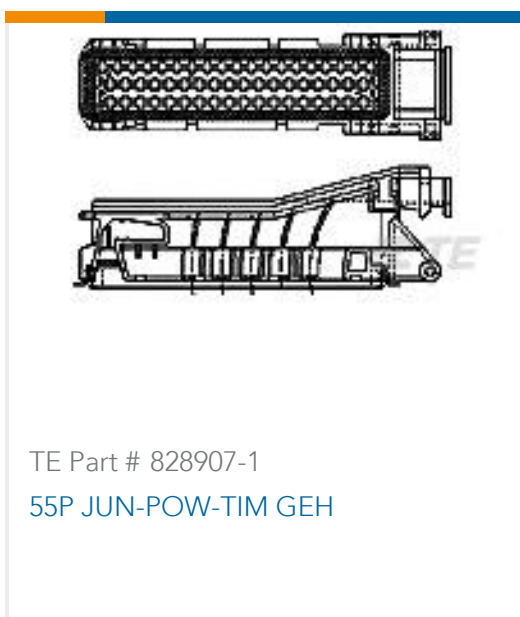

Also in the Series | Timer Connector System

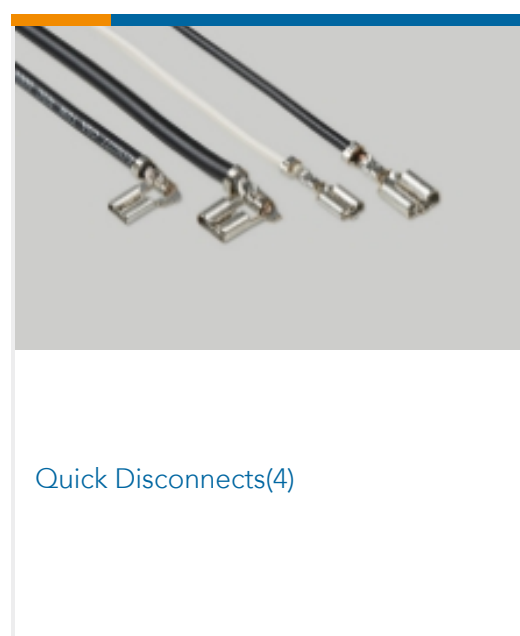
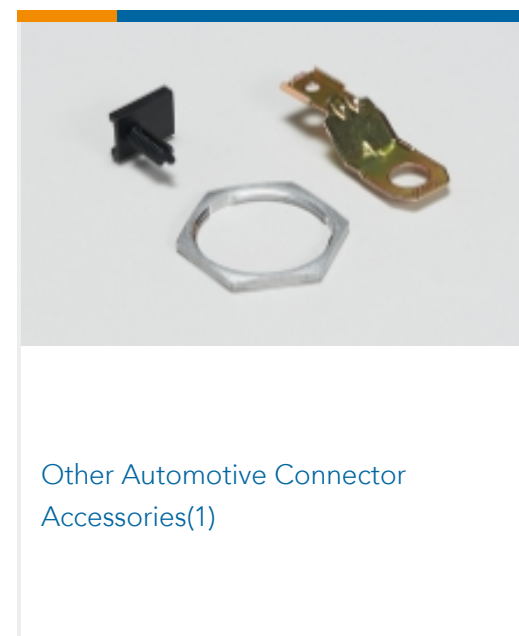
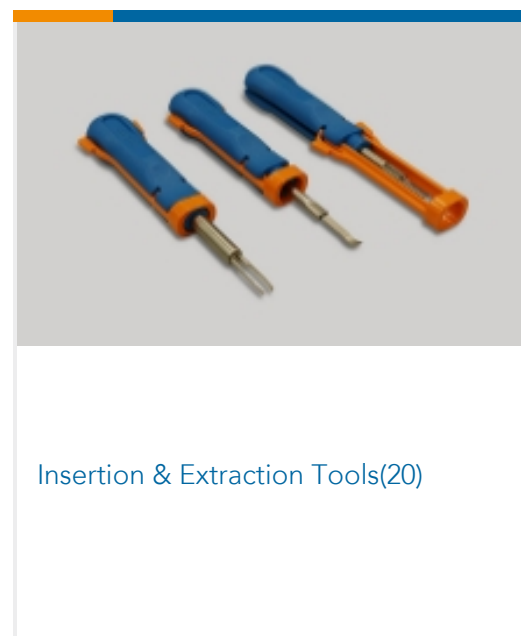
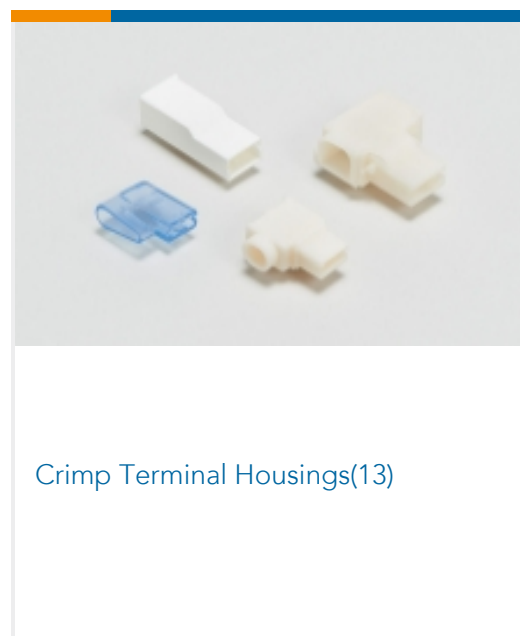
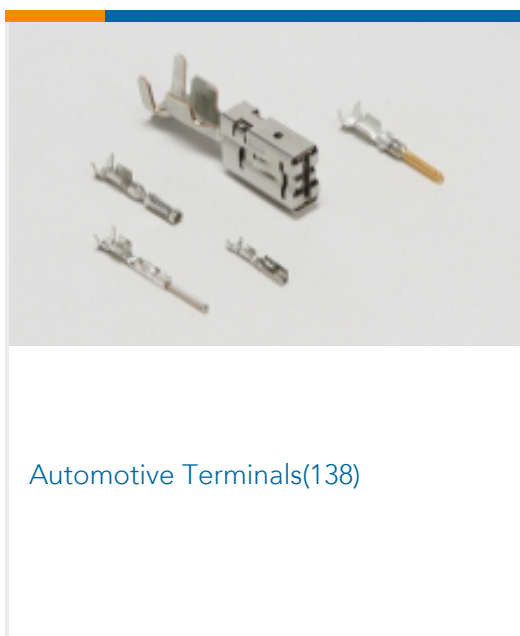
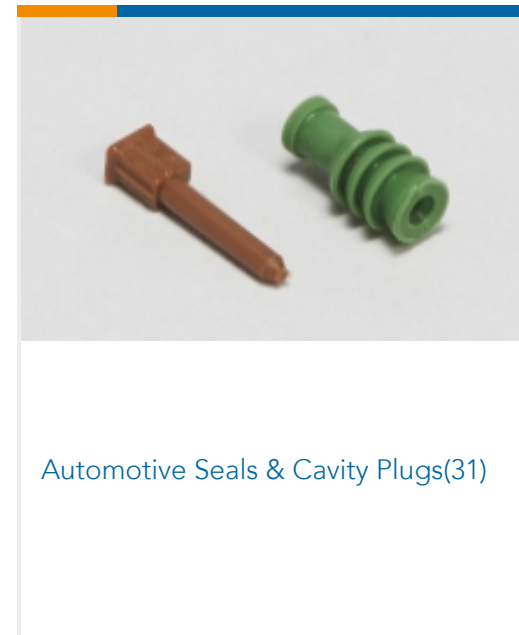
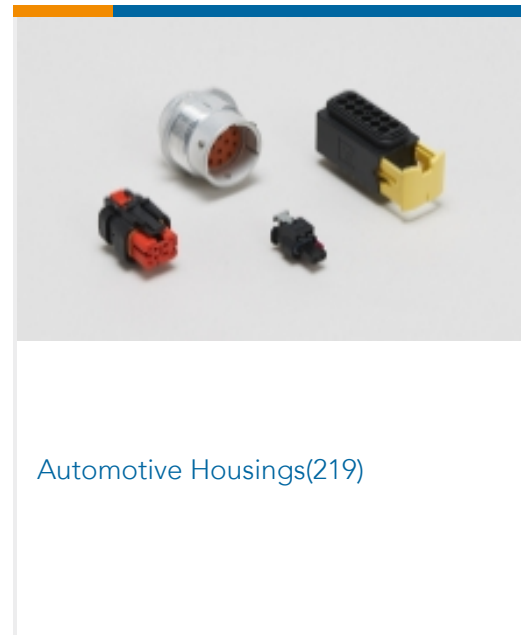
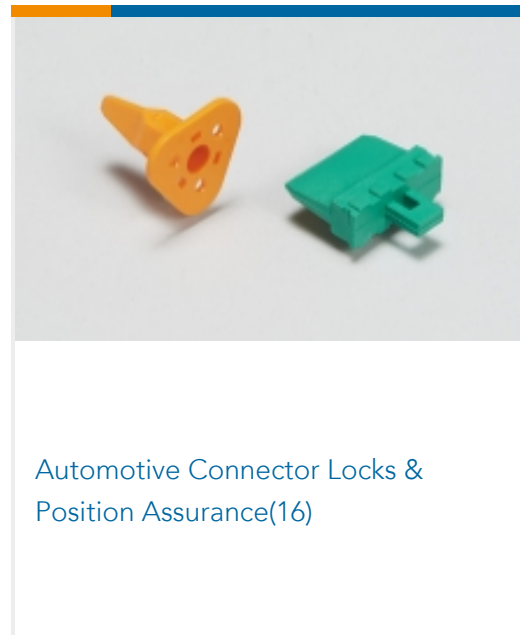
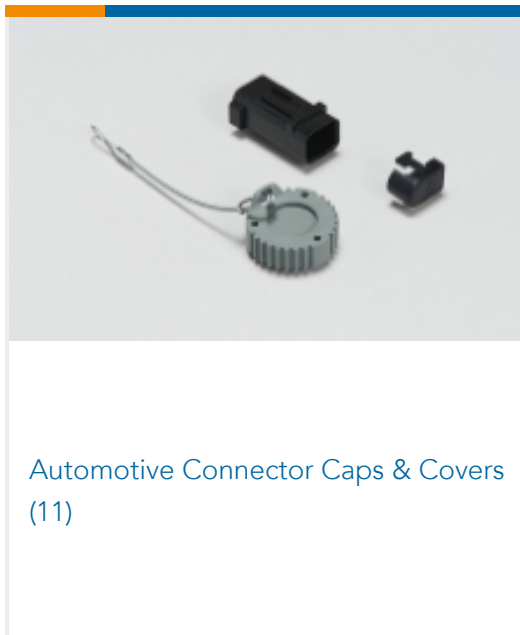

Customers Also Bought





TE Part #929942-1
JUN-POW-TIM KONTAKT

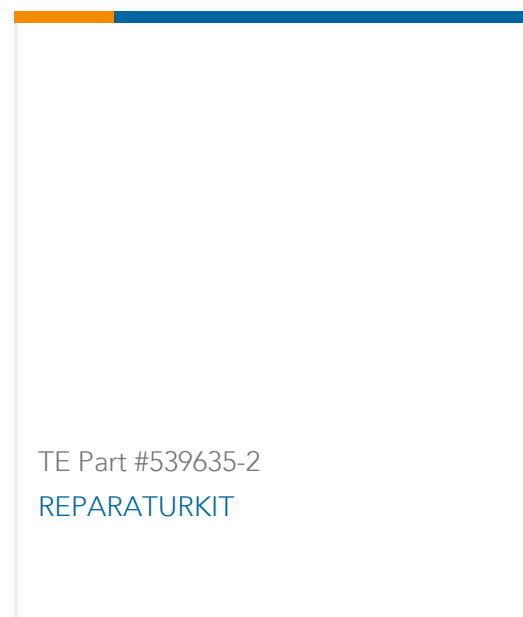

TE Part #539635-2
REPARATURKIT

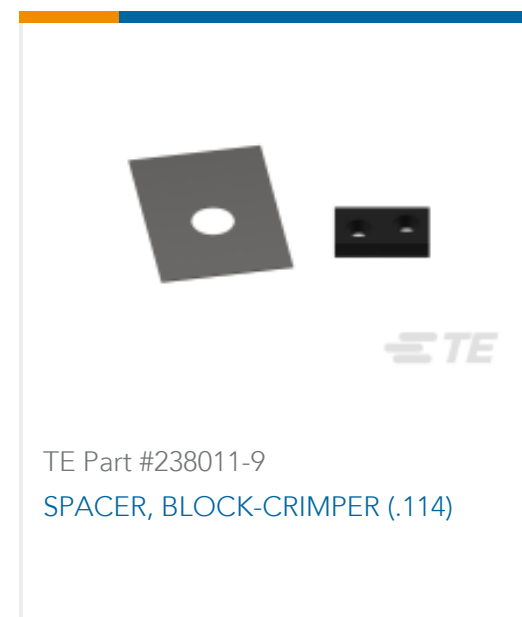

TE Part #238011-9
SPACER, BLOCK-CRIMPER (.114)

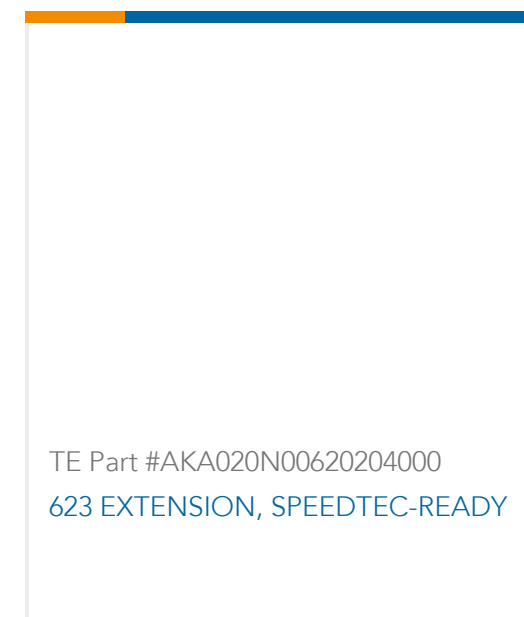

TE Part #AKA020N00620204000
623 EXTENSION, SPEEDTEC-READY

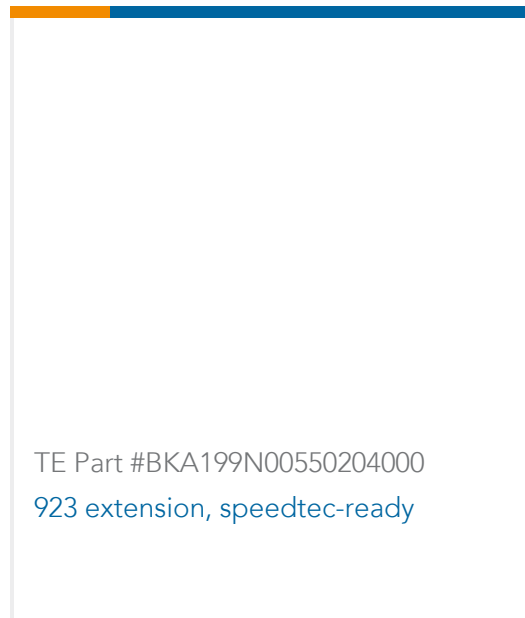

TE Part #BKA199N00550204000
923 extension, speedtec-ready

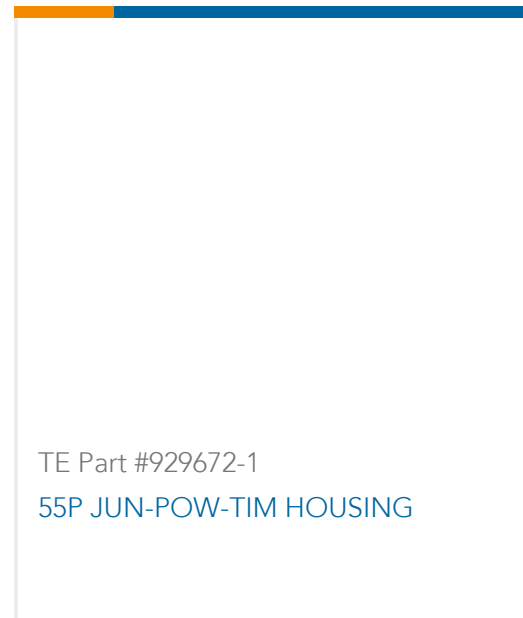

TE Part #929672-1
55P JUN-POW-TIM HOUSING

Documents

Product Drawings

[DECKEL F 55P GEH](#)

English

CAD Files

Customer View Model

[ENG_CVM_929674-1_3.3d_igs.zip](#)

English

Customer View Model

[ENG_CVM_929674-1_3.3d_stp.zip](#)

English

Customer View Model

[ENG_CVM_929674-1_3.2d_dxf.zip](#)

English

3D PDF

English

By downloading the CAD file I accept and agree to the [Terms and Conditions](#) of use.

Product Environmental Compliance

[Product Compliance](#)

English

[Product Compliance](#)

English