

936195-1 ✓ ACTIVE

Multilock Connector System

TE Internal #: 936195-1

Housing for Female Terminals, Wire-to-Wire, 76 Position, Black, Signal, Cable Mount (Free-Hanging), Multilock Connector System

[View on TE.com >](#)



Connectors > Automotive Connectors > Connector Housings > MULTILOCK, CONNECTOR HOUSING

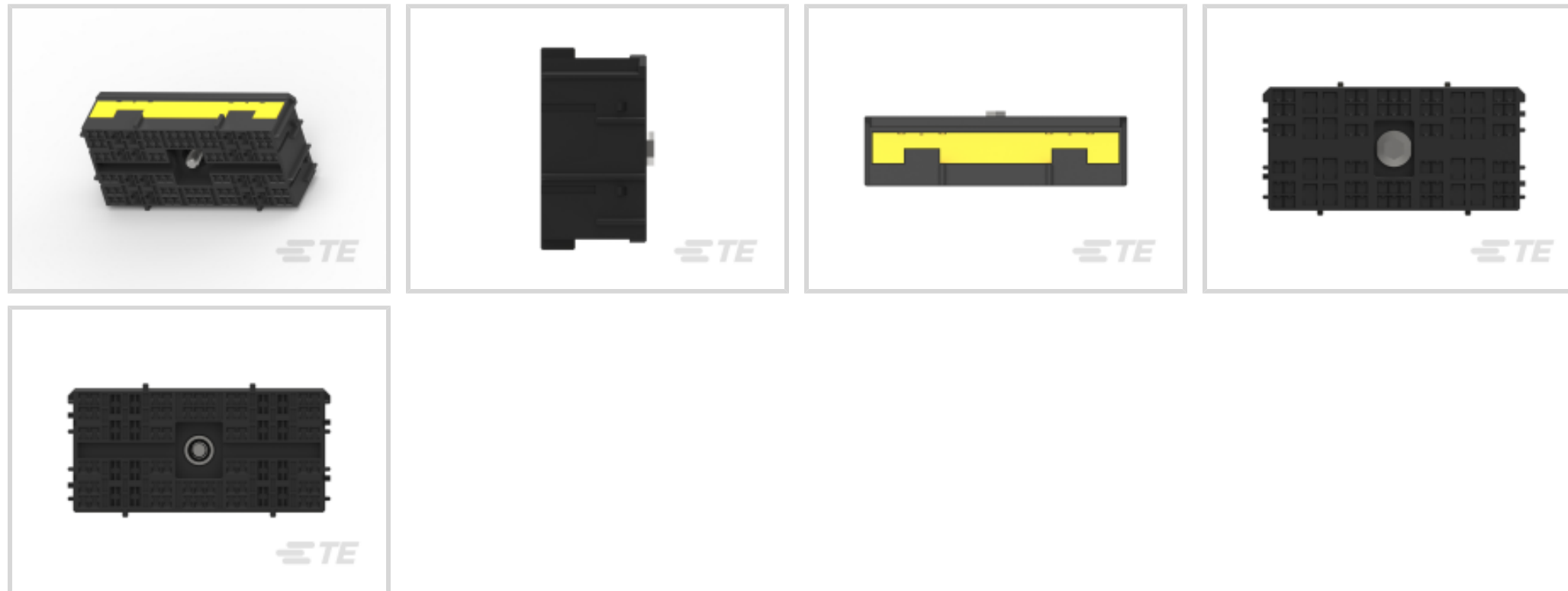

Connector & Housing Type: **Housing for Female Terminals**

Mating Tab Width: **6.3 mm [.248 in]**

Connector System: **Wire-to-Wire**

Number of Positions: **76**

Sealable: **No**

[All MULTILOCK, CONNECTOR HOUSING \(576\)](#)

Features

Product Type Features

Connector & Housing Shape	Rectangular
Connector & Housing Type	Housing for Female Terminals
Connector System	Wire-to-Wire
Sealable	No
Hybrid Connector	No
Primary Locking Feature	Integrated in Housing

Configuration Features

Number of Positions	76
---------------------	----

Body Features

Cable Exit Angle	180°
Body Material	PBT
Primary Product Color	Black

Contact Features



Contact Size	2.3mm
Contact Type	Receptacle
Mating Tab Width	6.3 mm[.248 in]

Mechanical Attachment

Mounting Feature	Without
Terminal Position Assurance	No
Strain Relief	Without
Mating Alignment Type	Polarized
Mating Alignment	With
Connector Mounting Type	Cable Mount (Free-Hanging)

Dimensions

Product Width	25 mm[.984 in]
Product Length	94 mm[3.7 in]
Product Height	44.3 mm[1.74 in]

Operation/Application

Circuit Application	Signal
---------------------	--------

Packaging Features

Packaging Quantity	48
Packaging Method	Box

Other

Serviceable	No
Connector Position Assurance Capable	No

Product Compliance

[For compliance documentation, visit the product page on TE.com>](#)

EU RoHS Directive 2011/65/EU	Compliant
EU ELV Directive 2000/53/EC	Compliant
China RoHS 2 Directive MIIT Order No 32, 2016	No Restricted Materials Above Threshold
EU REACH Regulation (EC) No. 1907/2006	Current ECHA Candidate List: JUNE 2022 (224) Candidate List Declared Against: JAN 2022 (223) SVHC > Threshold: Not Yet Reviewed

Halogen Content	Low Halogen - Br, Cl, F, I < 900 ppm per homogenous material. Also BFR/CFR/PVC Free
Solder Process Capability	Not applicable for solder process capability

Product Compliance Disclaimer

This information is provided based on reasonable inquiry of our suppliers and represents our current actual knowledge based on the information they provided. This information is subject to change. The part numbers that TE has identified as EU RoHS compliant have a maximum concentration of 0.1% by weight in homogenous materials for lead, hexavalent chromium, mercury, PBB, PBDE, DBP, BBP, DEHP, DIBP, and 0.01% for cadmium, or qualify for an exemption to these limits as defined in the Annexes of Directive 2011/65/EU (RoHS2). Finished electrical and electronic equipment products will be CE marked as required by Directive 2011/65/EU. Components may not be CE marked. Additionally, the part numbers that TE has identified as EU ELV compliant have a maximum concentration of 0.1% by weight in homogenous materials for lead, hexavalent chromium, and mercury, and 0.01% for cadmium, or qualify for an exemption to these limits as defined in the Annexes of Directive 2000/53/EC (ELV). Regarding the REACH Regulation, the information TE provides on SVHC in articles for this part number is based on the latest European Chemicals Agency (ECHA) 'Guidance on requirements for substances in articles' posted at this URL: <https://echa.europa.eu/guidance-documents/guidance-on-reach>

Compatible Parts



Also in the Series | Multilock Connector System

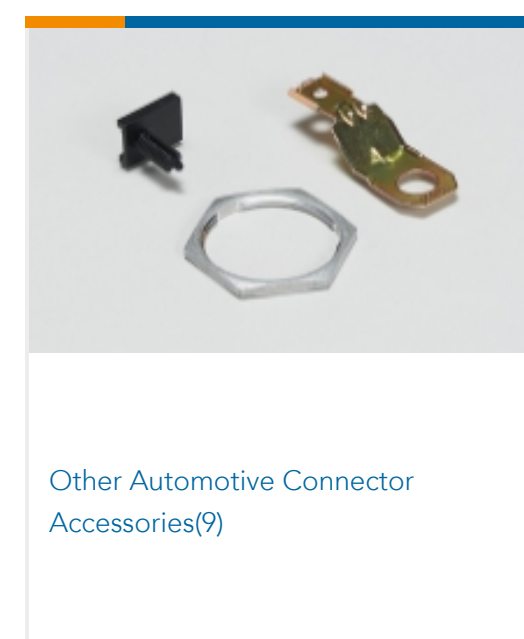
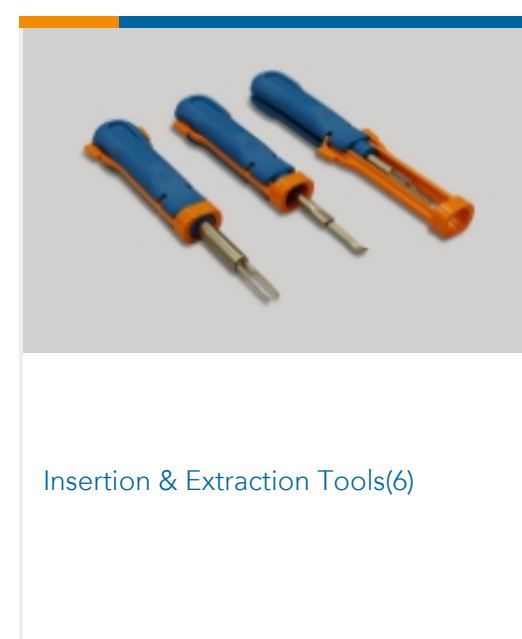
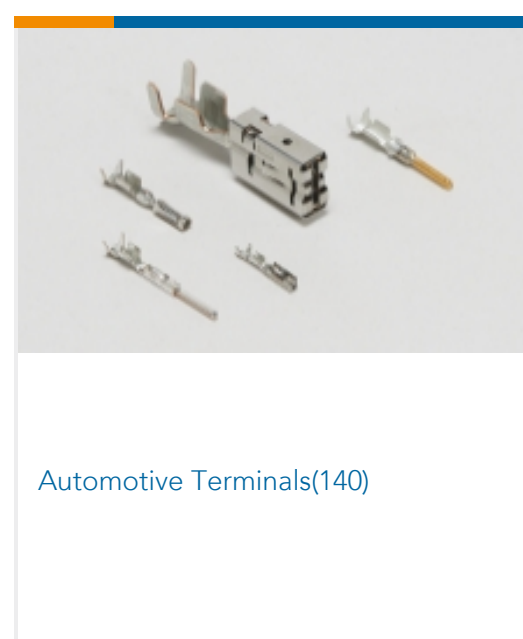
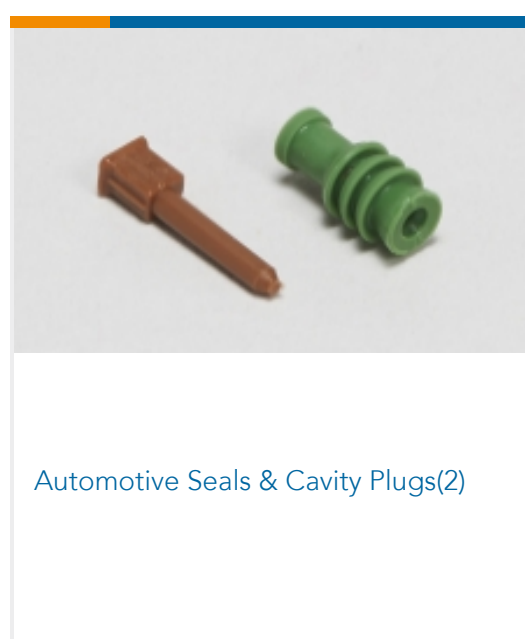
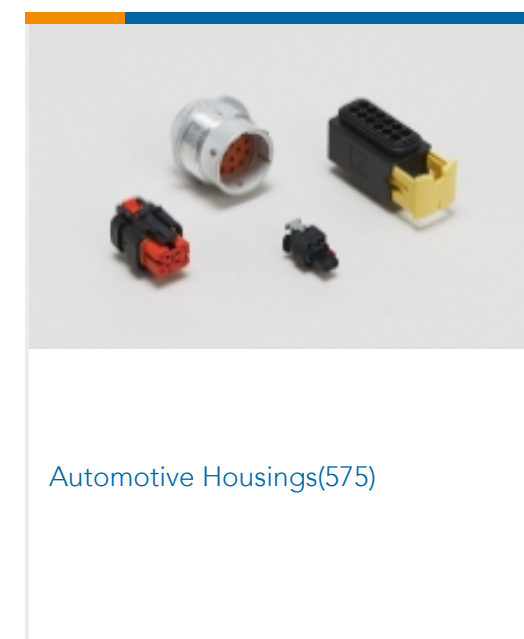
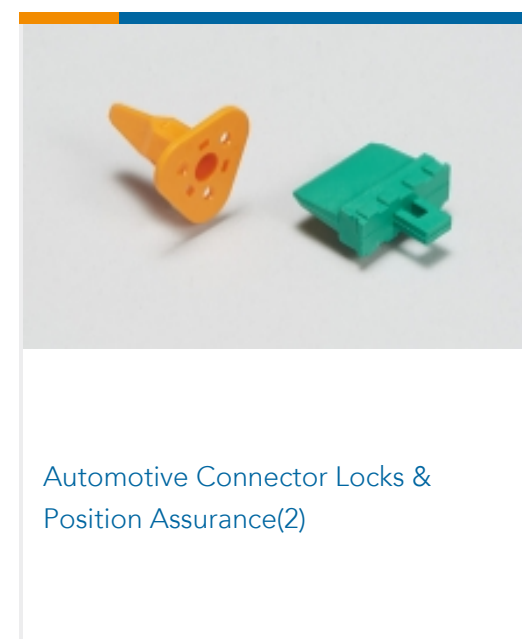
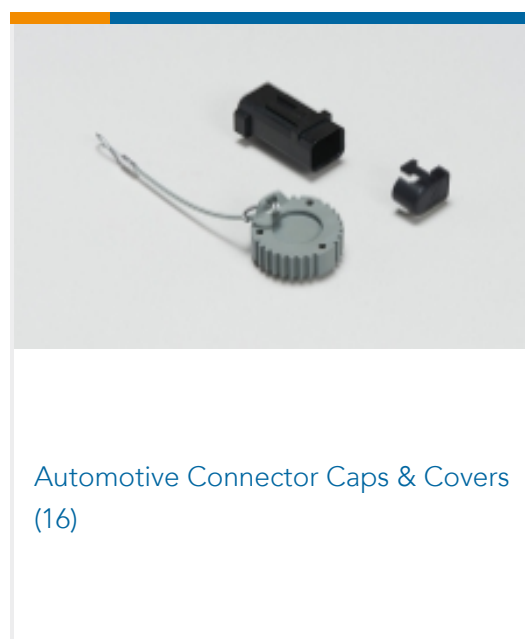

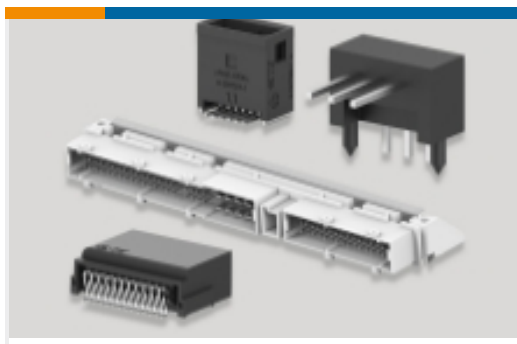

PCB Headers & Receptacles(129)

Customers Also Bought

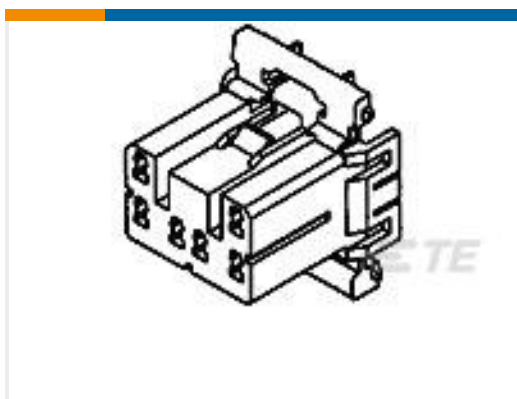
TE Part #1-1718644-1
3POS, MCON 1.2 LL REC SEALEDTE Part #927770-3
TIMER, RECEPTACLE AND TABTE Part #173633-1
MULTILOCK, RECEPTACLE AND TABTE Part #1743465-1
2.8MM MCP-E N-SLD REC(LL) CONTTE Part #368540-2
070 MLC PLUG 8P HSG BLACKTE Part #4-2098922-4
SDM,54P PLUG ASY,RHL,KEY DTE Part #5-2112502-7
38POS, MIXED,REC HSG,ASSY,
SEALEDTE Part #5-1299505-1
CABLE ASSY-180DEG SQUIBLOK
G2KCZ 2760

Documents

CAD Files

3D PDF

3D

Customer View Model

[ENG_CVM_CVM_936195-1_E.2d_dxf.zip](#)

English

Customer View Model

[ENG_CVM_CVM_936195-1_E.3d_igs.zip](#)

English

Customer View Model

[ENG_CVM_CVM_936195-1_E.3d_stp.zip](#)

English

By downloading the CAD file I accept and agree to the [Terms and Conditions](#) of use.

Datasheets & Catalog Pages

MULTILOCK Connector System

English

936195-1

Housing for Female Terminals, Wire-to-Wire, 76 Position, Black, Signal, Cable Mount
(Free-Hanging), Multilock Connector System

