

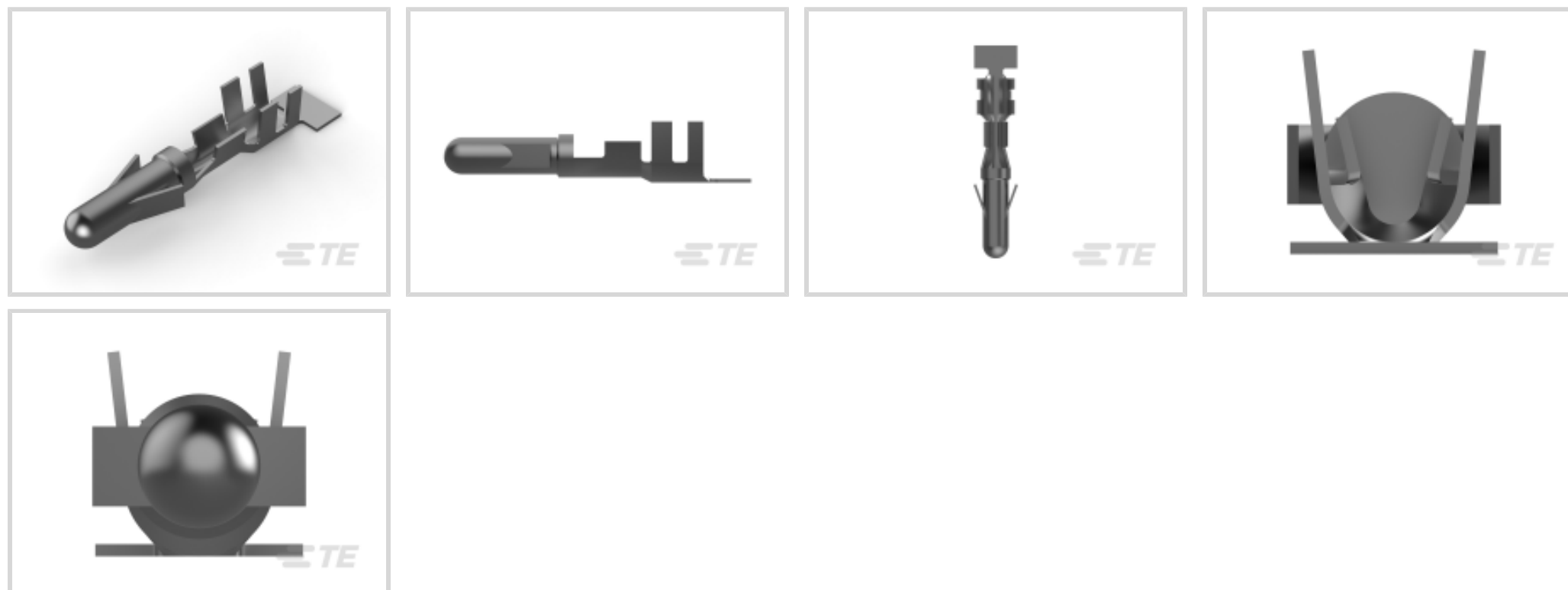

Connectors > Power Connectors > Power Contacts



Power Contact Type: **Contact**

Operating Voltage: **250 VAC**

Contact Mating Area Plating Material: **Pre-Tin**

Wire Size: **.5 – 2 mm<sup>2</sup>**

## Features

### Product Type Features

Power Contact Type	Contact
Connector System	Wire-to-Wire
Connector & Contact Terminates To	Wire & Cable

### Electrical Characteristics

Operating Voltage	250 VAC
-------------------	---------

### Contact Features

Contact Mating Area Plating Material	Pre-Tin
Contact Current Rating (Max)	17 A
Contact Type	Pin
Contact Retention Within Housing	With
Mating Pin Diameter	3.56 mm[.14 in]
Contact Base Material	Phosphor Bronze
Wire Contact Termination Area Plating Thickness	3 μm[118.1 μin]
Wire Contact Termination Area Plating Material	Pre-Tin
Wire Contact Termination Area Plating Material Finish	Matte



Contact Orientation	Straight
---------------------	----------

### Termination Features

Termination Method to Wire & Cable	Crimp
------------------------------------	-------

### Mechanical Attachment

Contact Retention Type Within Housing	Locking Lance
---------------------------------------	---------------

Connector Mounting Type	Cable Mount (Free-Hanging)
-------------------------	----------------------------

Wire Insulation Support	With
-------------------------	------

### Dimensions

Wire Size	.5 – 2 mm <sup>2</sup>
-----------	------------------------

Accepts Wire Insulation Diameter Range	2.5 – 4.5 mm [.098 – .177 in]
--	-------------------------------

### Usage Conditions

Operating Temperature Range	-55 – 105 °C [-67 – 221 °F]
-----------------------------	-----------------------------

### Operation/Application

Circuit Application	Power
---------------------	-------

### Industry Standards

Glow Wire Rating	Standard Part - Not Glow Wire
------------------	-------------------------------

### Packaging Features

Packaging Method	Reel
------------------	------

Packaging Quantity	2500
--------------------	------

### Other

Wire/Cable Type	Discrete Wire
-----------------	---------------

Comment	For Ambient Temperatures up to 120°C.
---------	---------------------------------------

### Product Compliance

[For compliance documentation, visit the product page on TE.com>](#)

EU RoHS Directive 2011/65/EU	Compliant
------------------------------	-----------

EU ELV Directive 2000/53/EC	Compliant
-----------------------------	-----------

China RoHS 2 Directive MIIT Order No 32, 2016	No Restricted Materials Above Threshold
---	---

EU REACH Regulation (EC) No. 1907/2006	Current ECHA Candidate List: JUNE 2022 (224) Candidate List Declared Against: JAN 2022 (223) SVHC > Threshold:
--	--



Not Yet Reviewed

Halogen Content

Low Halogen - Br, Cl, F, I < 900 ppm per homogenous material. Also BFR/CFR/PVC Free

Solder Process Capability

Not applicable for solder process capability

Product Compliance Disclaimer

This information is provided based on reasonable inquiry of our suppliers and represents our current actual knowledge based on the information they provided. This information is subject to change. The part numbers that TE has identified as EU RoHS compliant have a maximum concentration of 0.1% by weight in homogenous materials for lead, hexavalent chromium, mercury, PBB, PBDE, DBP, BBP, DEHP, DIBP, and 0.01% for cadmium, or qualify for an exemption to these limits as defined in the Annexes of Directive 2011/65/EU (RoHS2). Finished electrical and electronic equipment products will be CE marked as required by Directive 2011/65/EU. Components may not be CE marked. Additionally, the part numbers that TE has identified as EU ELV compliant have a maximum concentration of 0.1% by weight in homogenous materials for lead, hexavalent chromium, and mercury, and 0.01% for cadmium, or qualify for an exemption to these limits as defined in the Annexes of Directive 2000/53/EC (ELV). Regarding the REACH Regulation, the information TE provides on SVHC in articles for this part number is based on the latest European Chemicals Agency (ECHA) 'Guidance on requirements for substances in articles' posted at this URL: <https://echa.europa.eu/guidance-documents/guidance-on-reach>

## Compatible Parts



TE Part # 1-480586-0  
09P .140 MNL CAP NAT



TE Part # 1-350347-0  
03P .140 MNL CAP PM NAT



TE Part # 880125  
9 CIR CAP 140DIA PANEL MT NAT



TE Part # 1-480673-0  
09P .140 MNL CAP PM NAT



TE Part # 1-350345-0  
02P .140 MNL CAP P/M NAT



TE Part # 2305570-1  
TERMINAL CUTTER, SIDE FEED



TE Part # 1-480512-0  
04P .140 MNL CAP NAT



TE Part # 794683-1  
09P .140 MNL CAP BLK HT



TE Part # 539764-1  
EXTRACTION TOOL



TE Part # 925450-1  
M-N-L PIN HSG

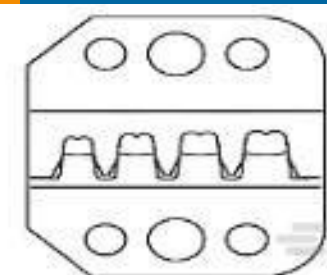

TE Part # 1752938-2  
SDE DIE SET 3.5 MM MNL



TE Part # 2-2151320-1  
OCEAN\_2.0\_APPLICATOR-S-100F190O180F



TE Part # 2-2151320-2  
OCEAN\_2.0\_APPLICATOR-S-100F190O180FA



TE Part # 2151320-1  
OCEAN\_2.0\_APPLICATOR-S-100F190O180F



TE Part # 2151320-2  
OCEAN\_2.0\_APPLICATOR-S-100F190O180FA



TE Part # 7-2151320-1  
OCEAN\_2.0\_APPLICATOR-S-100F190O180F



TE Part # 7-2151320-2  
OCEAN\_2.0\_APPLICATOR-S-100F190O180FA



**KIT**  
REPRESENTATION ONLY

TE Part # 7-2151320-7  
OCEAN\_2.0\_SPARE\_PART\_KIT-100F190O180F



TE Part # 794061-1  
03P .140 MNL CAP BLK HT



TE Part # 926915-1  
3,5 MNL PCB HYLSE

## Also in the Series | Commercial MATE-N-LOK



Connector Contacts(26)



Crimp Wire Pins, Tabs & Ferrules(3)



Insertion & Extraction Tools(5)

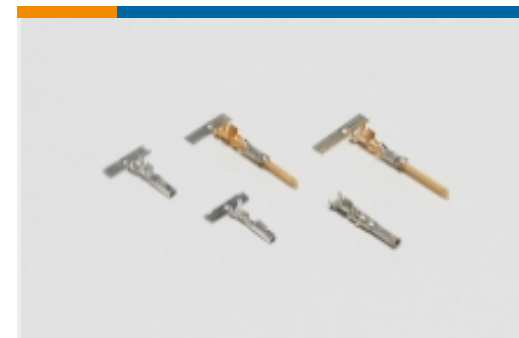

Power Contacts(129)



Rectangular Caps & Covers(2)



Rectangular Connector Housings(17)



Rectangular Connector Seals(1)



Rectangular Power Connectors(170)



Standard Circular Connectors(4)

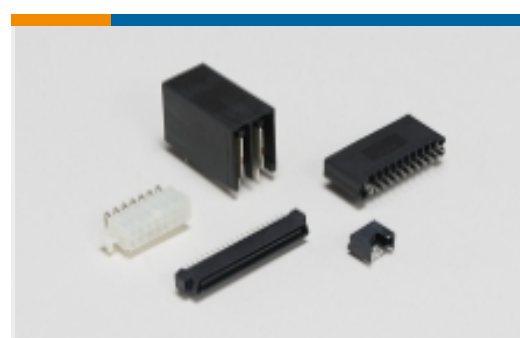

Standard Rectangular Connectors(10)



Wire-to-Board Connector Contacts(1)

## Customers Also Bought



TE Part #929505-5  
TIMER, CONNECTOR HOUSING

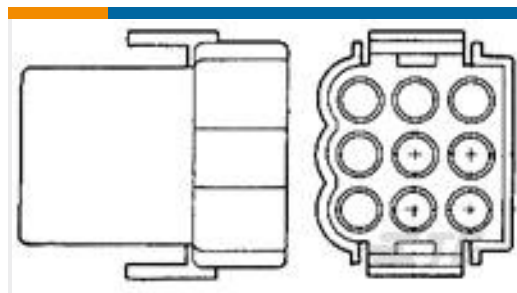

TE Part #1-480673-0  
09P .140 MNL CAP PM NAT



TE Part #925714-2  
MATENLOK SOCKET.140



TE Part #925714-1  
MATENLOK SOCKET



TE Part #160860-4  
FF 250 REC 0.5-1.0MM2 TPPB



TE Part #8-968972-1  
MCP 2.8 GEH 12P



TE Part #925856-1  
WIRE PIN 15.5-13.5 AWG .01 PTPB

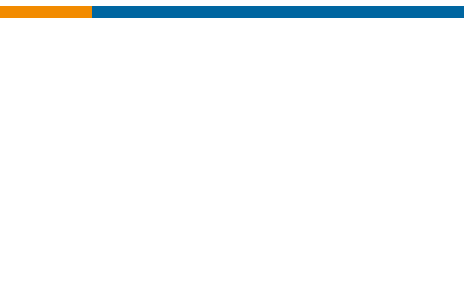

TE Part #172508-1  
MIC CAP HSG 13P MK II

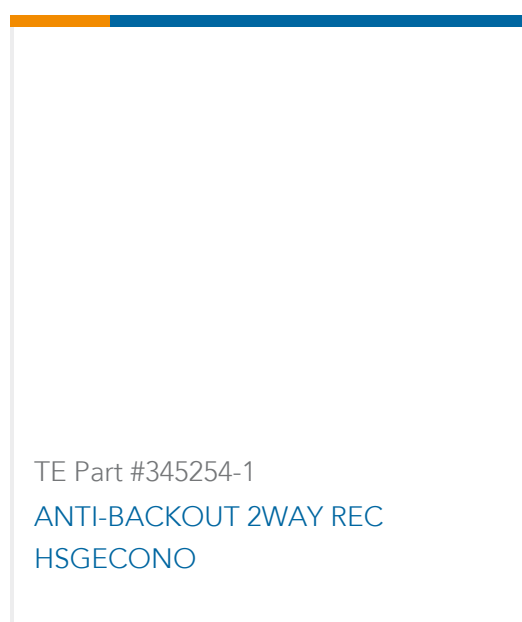

TE Part #345254-1  
ANTI-BACKOUT 2WAY REC  
HSGECONO

## Documents

### CAD Files

Customer View Model

[ENG\\_CVM\\_925715-2\\_Y.3d\\_igs.zip](#)

English

Customer View Model

[ENG\\_CVM\\_925715-2\\_Y.3d\\_stp.zip](#)

English

Customer View Model

[ENG\\_CVM\\_925715-2\\_Y.2d\\_dxf.zip](#)

English

### 3D PDF

English

By downloading the CAD file I accept and agree to the [Terms and Conditions](#) of use.

### Product Specifications

Product Specification

English

### Product Environmental Compliance



**Product Compliance**

English

**Product Compliance**

English