

929964-1 ✓ ACTIVE

AMP | Round Connector System

TE Internal #: 929964-1

Automotive Terminals, Pin, Pin Diameter .098 in [2.5 mm], 17 – 13

AWG Wire Size, 1 – 2.5 mm² Wire Size, Locking Locking Lance,

Round Connector System

[View on TE.com >](#)



Terminals & Splices > Automotive Terminals > ROUND CONNECTOR SYSTEM, PIN AND SOCKET

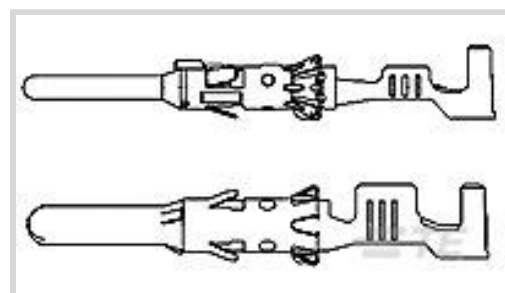

Terminal Type: Pin

Mating Pin Diameter: 2.5 mm [.098 in]

Terminal Transmits: 25 – 40 A (Power)

Wire Size: 1 – 2.5 mm²

[All Round Connector System, Pin and Socket \(74\)](#)

Features

Product Type Features

Receptacle Style	180°
Sealable	No
Primary Locking Feature	Locking Lance

Contact Features

Contact Size	2.5mm
Contact Fabrication	Stamped & Formed
Typical Current Rating	34 A
Crimp Type	F-Crimp
Terminal Type	Pin
Mating Pin Diameter	2.5 mm[.098 in]
Interface Plating	Tin (Sn)
Contact Termination Area Plating Material	Tin (Sn)

Termination Features

Termination Method to Wire & Cable	Crimp
Product Terminates To	Wire

Dimensions

Wire Size	1 – 2.5 mm ²
-----------	-------------------------



Wire Size Search	13 AWG, 14 AWG, 15 AWG, 16 AWG, 17 AWG
------------------	--

Wire Insulation Diameter	1.9 – 3 mm [.074 – .118 in]
--------------------------	-----------------------------

Usage Conditions

Insulation Option	Uninsulated
-------------------	-------------

Operating Temperature (Max)	80 °C, 85 °C, 90 °C, 100 °C, 105 °C, 110 °C, 120 °C, 125 °C, 130 °C [176 °F][185 °F][194 °F][212 °F][221 °F][230 °F][248 °F][257 °F][266 °F]
-----------------------------	--

Operating Temperature Range	-40 – 130 °C [-40 – 266 °F]
-----------------------------	-----------------------------

Operation/Application

Compatible With Wire Base Material	Copper
------------------------------------	--------

Packaging Features

Packaging Method	Reel
------------------	------

Packaging Quantity	3500
--------------------	------

Other

Terminal Transmits	25 – 40 A (Power)
--------------------	-------------------

Product Compliance

[For compliance documentation, visit the product page on TE.com>](#)

EU RoHS Directive 2011/65/EU	Compliant
------------------------------	-----------

EU ELV Directive 2000/53/EC	Compliant
-----------------------------	-----------

China RoHS 2 Directive MIIT Order No 32, 2016	No Restricted Materials Above Threshold
---	---

EU REACH Regulation (EC) No. 1907/2006	Current ECHA Candidate List: JUNE 2022 (224) Candidate List Declared Against: JUNE 2022 (224) Does not contain REACH SVHC
--	---

Halogen Content	Low Halogen - Br, Cl, F, I < 900 ppm per homogenous material. Also BFR/CFR/PVC Free
-----------------	---

Solder Process Capability	Not applicable for solder process capability
---------------------------	--

Product Compliance Disclaimer

This information is provided based on reasonable inquiry of our suppliers and represents our current actual knowledge based on the information they provided. This information is subject to change. The part numbers that TE has identified as EU RoHS compliant have a maximum concentration of 0.1% by weight in homogenous materials for lead, hexavalent chromium, mercury, PBB, PBDE, DBP, BBP, DEHP, DIBP, and 0.01% for cadmium, or qualify for an exemption to these limits as defined in the Annexes of Directive 2011/65/EU (RoHS2). Finished electrical and electronic equipment products

will be CE marked as required by Directive 2011/65/EU. Components may not be CE marked. Additionally, the part numbers that TE has identified as EU ELV compliant have a maximum concentration of 0.1% by weight in homogenous materials for lead, hexavalent chromium, and mercury, and 0.01% for cadmium, or qualify for an exemption to these limits as defined in the Annexes of Directive 2000/53/EC (ELV). Regarding the REACH Regulation, the information TE provides on SVHC in articles for this part number is based on the latest European Chemicals Agency (ECHA) 'Guidance on requirements for substances in articles' posted at this URL: <https://echa.europa.eu/guidance-documents/guidance-on-reach>

Compatible Parts

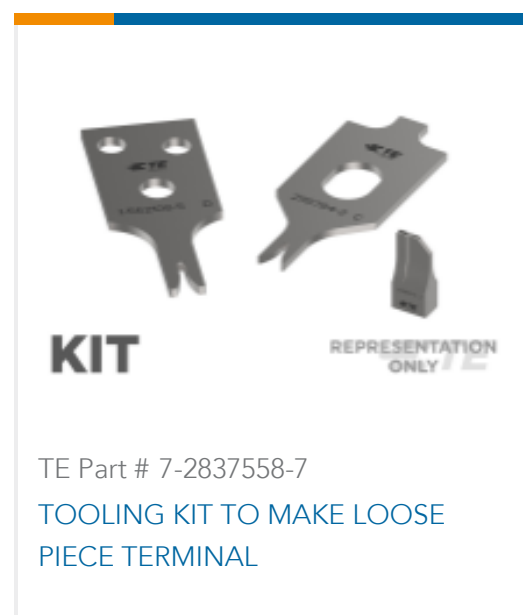
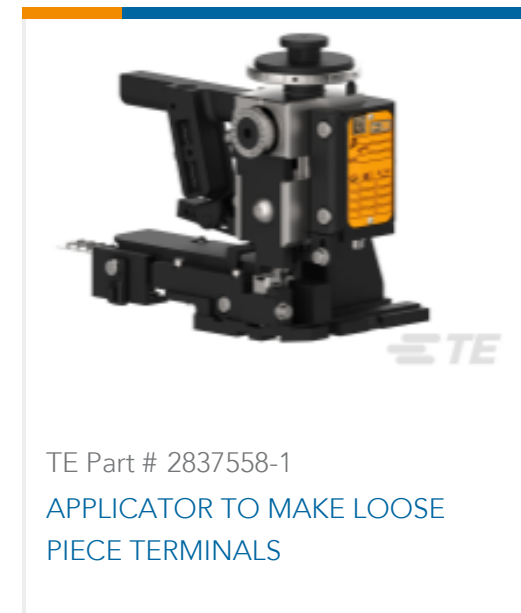
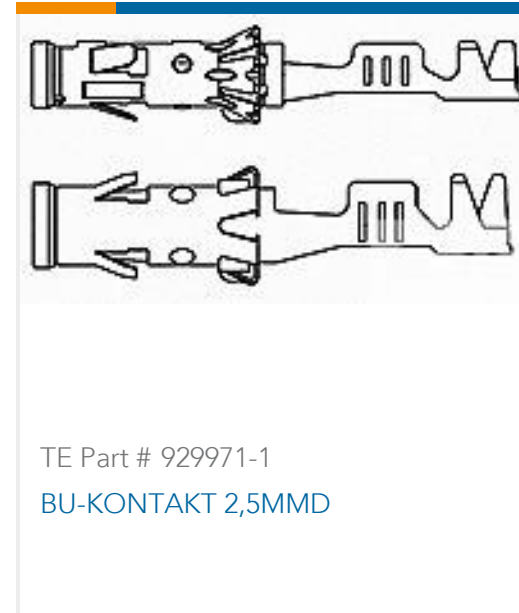

Also in the Series | Round Connector System

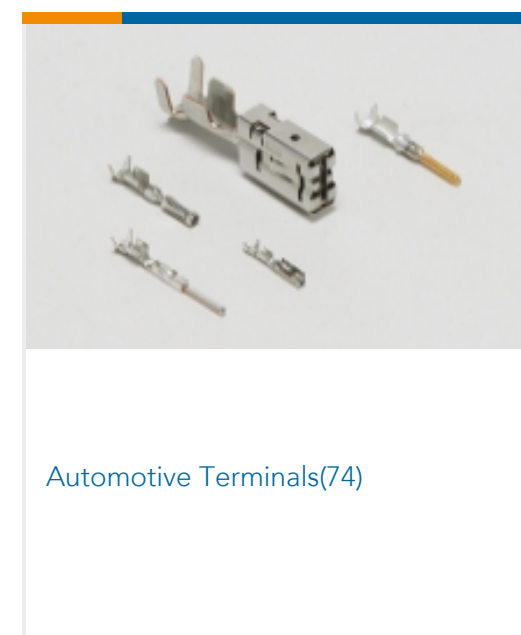
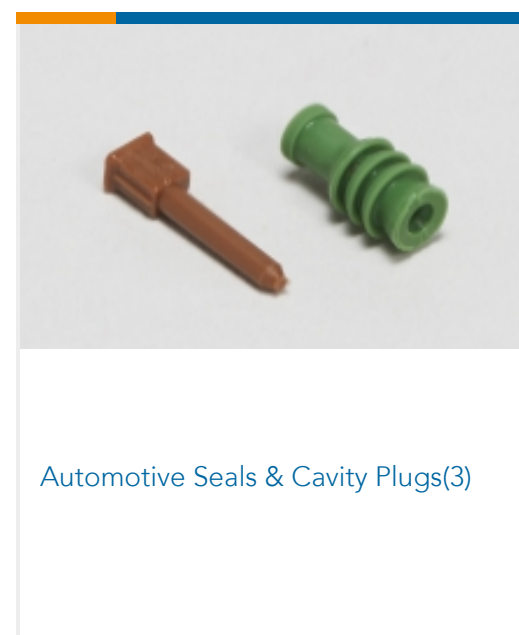
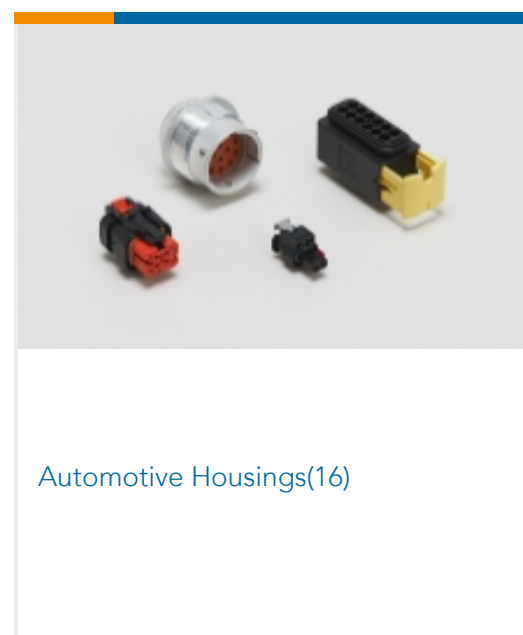
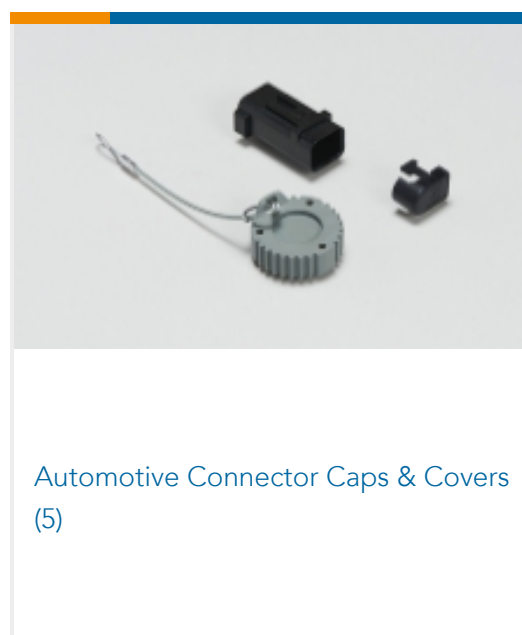



Insertion & Extraction Tools(8)

Customers Also Bought

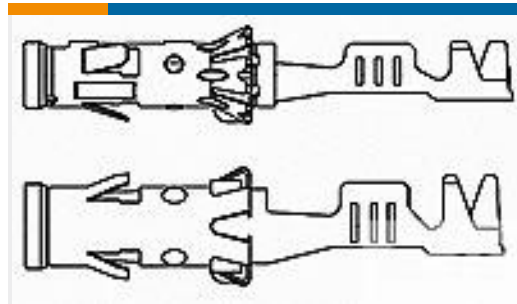
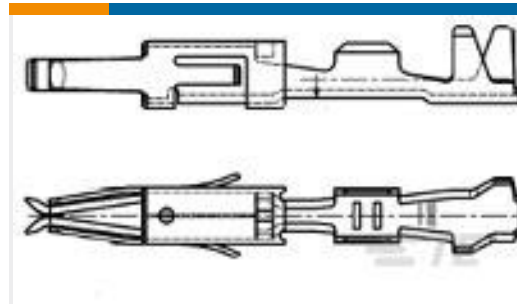
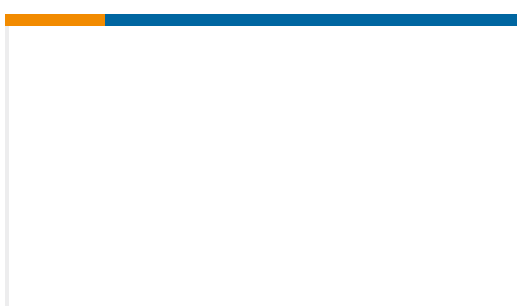
TE Part #965784-1
connector ABDECKKAPPE 180GRDTE Part #929975-1
BU-KONTAKT 2,5MMDTE Part #962875-2
MT2 REC 1.6 Contact SWS SnTE Part #1718232-1
1,5MM /2.5MM PIN HSG 31POSTE Part #4-965641-1
TAB HSG 2.8MM 6POS.TE Part #1-1823440-1
22POS, MIXED, REC HSG, ASSY,
SEALEDTE Part #3-456407-1
CRIMPER, WIRETE Part #9053023001
ACW0219-0.75-54(NS)TE Part #2256741-1
SWITCH, 2MM SENSING DISTANCE,
3 PORT

CRIMPER REPRESENTATION ONLY

TE Part #4-571016-1
WIRE CRIMPER

Documents

Product Drawings

[STIFTKONTAKT 2,5MMD](#)

English

[STIFTKONTAKT 2,5MMD](#)

German

CAD Files

Customer View Model

[ENG_CVM_929964-1_A2.3d_igs.zip](#)



English

Customer View Model

[ENG_CVM_929964-1_A2.3d_stp.zip](#)

English

Customer View Model

[ENG_CVM_929964-1_A2.2d_dxf.zip](#)

English

[3D PDF](#)

English

By downloading the CAD file I accept and agree to the [Terms and Conditions](#) of use.

Datasheets & Catalog Pages

[Heavy Duty Connectors](#)

English

[CONNECTOR SELECTOR](#)

English

Product Specifications

[Application Specification](#)

English

[Application Specification](#)

English