



Sealed Sensor Connector SSC System

TE Internal #: 936113-1

Automotive Connector Caps & Covers, Cover - Cable Exit, Cable Exit Angle 180° (In-Line), Black, PA, Sealed Sensor Connector SSC System

[View on TE.com >](#)

Connectors > Automotive Connectors > Connector Accessories > Connector Caps & Covers



Protection & Strain Relief Accessory Type: **Cover - Cable Exit**

Cable Exit Angle: **180° (In-Line)**

Strain Relief: **With**

Primary Product Color: **Black**

Primary Product Material: **PA**

Features

Product Type Features

Protection & Strain Relief Accessory Type	Cover - Cable Exit
Connector System	Wire-to-Board, Wire-to-Device

Configuration Features

Number of Positions	5
---------------------	---

Body Features

Cable Exit Angle	180° (In-Line)
Primary Product Color	Black
Primary Product Material	PA

Mechanical Attachment

Strain Relief	With
---------------	------

Dimensions

Compatible Cable Bundle Diameter Range	8.2 mm[.323 in]
--	-----------------

Usage Conditions

--	--



Operating Temperature (Max)	70 °C, 75 °C, 80 °C, 85 °C, 90 °C, 100 °C, 105 °C, 110 °C, 120 °C[158 °F][167 °F][176 °F][185 °F][194 °F][212 °F][221 °F][230 °F][248 °F]
Operating Temperature Range	-40 – 120 °C[-40 – 248 °F]

Industry Standards

UL Flammability Rating	UL 94HB
------------------------	---------

Packaging Features

Packaging Quantity	500
Packaging Method	Bag

Other

Serviceable	Yes
-------------	-----

Product Compliance

[For compliance documentation, visit the product page on TE.com>](#)

EU RoHS Directive 2011/65/EU	Compliant
EU ELV Directive 2000/53/EC	Compliant
China RoHS 2 Directive MIIT Order No 32, 2016	No Restricted Materials Above Threshold
EU REACH Regulation (EC) No. 1907/2006	Current ECHA Candidate List: JUNE 2022 (224) Candidate List Declared Against: JUNE 2022 (224) Does not contain REACH SVHC
Halogen Content	Low Halogen - Br, Cl, F, I < 900 ppm per homogenous material. Also BFR/CFR/PVC Free
Solder Process Capability	Not applicable for solder process capability

Product Compliance Disclaimer

This information is provided based on reasonable inquiry of our suppliers and represents our current actual knowledge based on the information they provided. This information is subject to change. The part numbers that TE has identified as EU RoHS compliant have a maximum concentration of 0.1% by weight in homogenous materials for lead, hexavalent chromium, mercury, PBB, PBDE, DBP, BBP, DEHP, DIBP, and 0.01% for cadmium, or qualify for an exemption to these limits as defined in the Annexes of Directive 2011/65/EU (RoHS2). Finished electrical and electronic equipment products will be CE marked as required by Directive 2011/65/EU. Components may not be CE marked. Additionally, the part numbers that TE has identified as EU ELV compliant have a maximum concentration of 0.1% by weight in homogenous materials for lead, hexavalent chromium, and mercury, and 0.01% for cadmium, or qualify for an exemption to these limits as defined in the Annexes of Directive 2000/53/EC (ELV). Regarding the REACH Regulation, the information TE provides on SVHC in articles for this part number is based on the latest European Chemicals Agency (ECHA) 'Guidance on requirements for substances in articles' posted at this URL: <https://echa.europa.eu/guidance-documents/guidance-on-reach>



Compatible Parts



TE Part # CAT-AM705-CH8172
AMP MCP, SEALED CONNECTOR HOUSING

Also in the Series | Sealed Sensor Connector SSC System



Automotive Connector Caps & Covers (7)



Automotive Connector Locks & Position Assurance(6)



Automotive Housings(174)



Automotive Seals & Cavity Plugs(3)



Automotive Terminals(8)



Insertion & Extraction Tools(1)



Other Automotive Connector Accessories(7)

Customers Also Bought



TE Part #DT04-2P
DEUTSCH DT Series Housings & Connectors



TE Part #W2S
DEUTSCH DT WEDGELOCKS



TE Part #282104-1
AMP SUPERSEAL 1.5MM, CONNECTOR HOUSING



TE Part #206070-8
CABLE CLAMP KIT #17

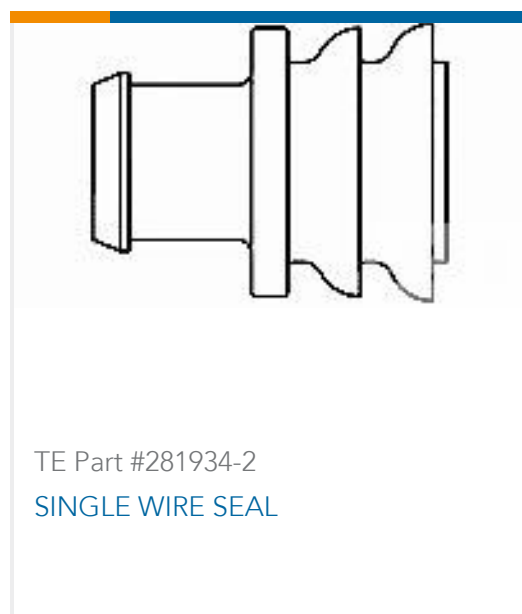

Documents

Product Drawings

2.8mm Sealed 5P Cover

English

CAD Files

3D PDF

3D

Customer View Model

[ENG_CVM_CVM_936113-1_C.2d_dxf.zip](#)

English

Customer View Model

[ENG_CVM_CVM_936113-1_C.3d_igs.zip](#)

English

Customer View Model

[ENG_CVM_CVM_936113-1_C.3d_stp.zip](#)

English

By downloading the CAD file I accept and agree to the [Terms and Conditions](#) of use.

Product Specifications

2.8MM series

English