

794281-1 ✓ ACTIVE

MATE-N-LOK | Universal MATE-N-LOK

TE Internal #: 794281-1

Rectangular Connector Seals, Interface Seal, Wire-to-Wire, -55 – 105 °C [-67 – 221 °F], Universal MATE-N-LOK

[View on TE.com >](#)



Connectors > Rectangular Connectors > Rectangular Connector Accessories > Rectangular Connector Seals

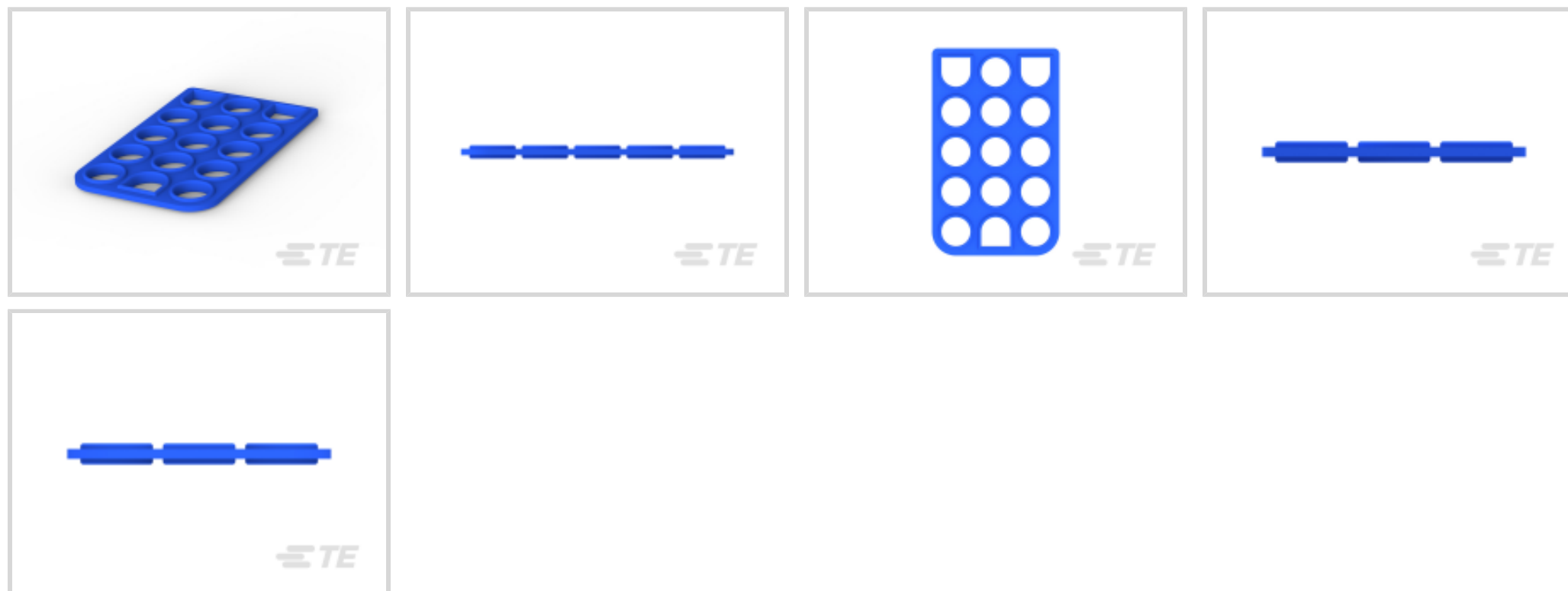

Connector Seal Type: **Interface Seal**

Connector System: **Wire-to-Wire**

Operating Temperature Range: **-55 – 105 °C [-67 – 221 °F]**

Features

Product Type Features

Accessory Color	Blue
Product Type	Accessory
Connector Seal Type	Interface Seal
Connector System	Wire-to-Wire

Body Features

Material	Silicone Rubber
Color	Blue

Usage Conditions

Operating Temperature Range	-55 – 105 °C[-67 – 221 °F]
-----------------------------	----------------------------

Operation/Application

For Use With	Universal MATE-N-LOK Sealed Connectors
--------------	--

Packaging Features

Packaging Method	Bag/Box
Packaging Quantity	500

Product Compliance







[For compliance documentation, visit the product page on TE.com>](#)

EU RoHS Directive 2011/65/EU	Compliant
EU ELV Directive 2000/53/EC	Compliant
China RoHS 2 Directive MIIT Order No 32, 2016	No Restricted Materials Above Threshold
EU REACH Regulation (EC) No. 1907/2006	Current ECHA Candidate List: JUNE 2022 (224) Candidate List Declared Against: JAN 2022 (223) SVHC > Threshold: Not Yet Reviewed
Halogen Content	Not Yet Reviewed for halogen content
Solder Process Capability	Not applicable for solder process capability

Product Compliance Disclaimer

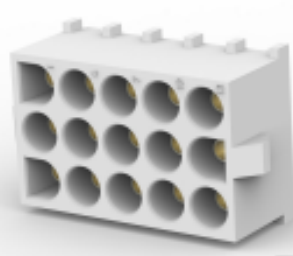
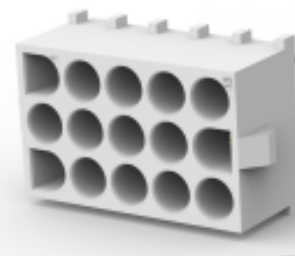
This information is provided based on reasonable inquiry of our suppliers and represents our current actual knowledge based on the information they provided. This information is subject to change. The part numbers that TE has identified as EU RoHS compliant have a maximum concentration of 0.1% by weight in homogenous materials for lead, hexavalent chromium, mercury, PBB, PBDE, DBP, BBP, DEHP, DIBP, and 0.01% for cadmium, or qualify for an exemption to these limits as defined in the Annexes of Directive 2011/65/EU (RoHS2). Finished electrical and electronic equipment products will be CE marked as required by Directive 2011/65/EU. Components may not be CE marked. Additionally, the part numbers that TE has identified as EU ELV compliant have a maximum concentration of 0.1% by weight in homogenous materials for lead, hexavalent chromium, and mercury, and 0.01% for cadmium, or qualify for an exemption to these limits as defined in the Annexes of Directive 2000/53/EC (ELV). Regarding the REACH Regulation, the information TE provides on SVHC in articles for this part number is based on the latest European Chemicals Agency (ECHA) 'Guidance on requirements for substances in articles' posted at this URL: <https://echa.europa.eu/guidance-documents/guidance-on-reach>

Compatible Parts

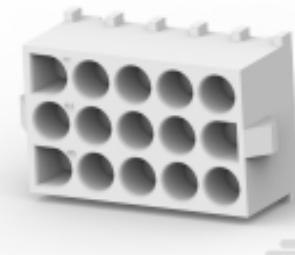
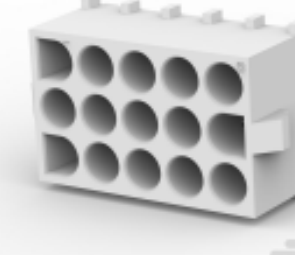
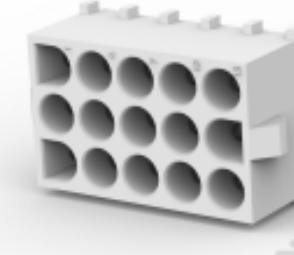
 TE Part # 350830-4 15P UMNL HDR ASSY PC 94VO LF	 TE Part # 350738-4 15P UMNL PIN HDR ASSY 94VO LF	 TE Part # 350784-1 15P UMNL CAP HSG	 TE Part # 350736-1 15P UMNL PLUG HSG
 TE Part # 350765-4 15P UMNL HDR ASSY PC	 TE Part # 643430-1 15P UMNL HDR ASSY POL 94VO	 TE Part # 350738-1 15P UMNL PIN HDR ASSY 94VO	 TE Part # 350830-1 15P UMNL HDR ASSY PC 94VO



Also in the Series | **Universal MATE-N-LOK**

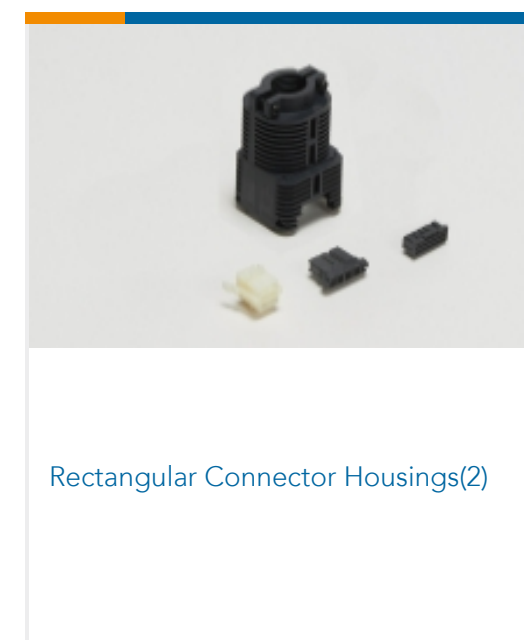
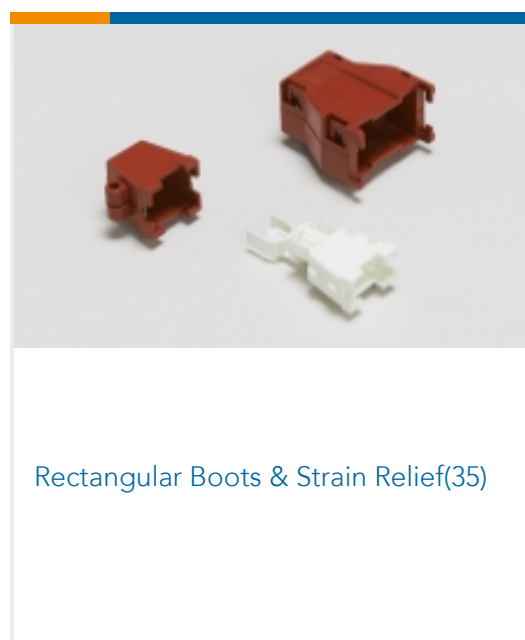
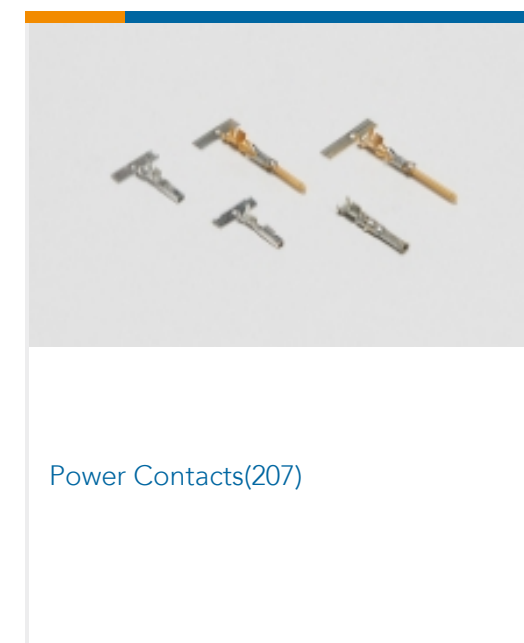
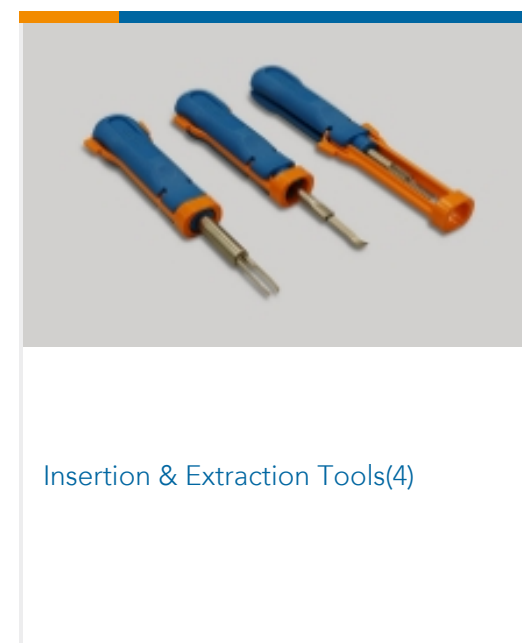
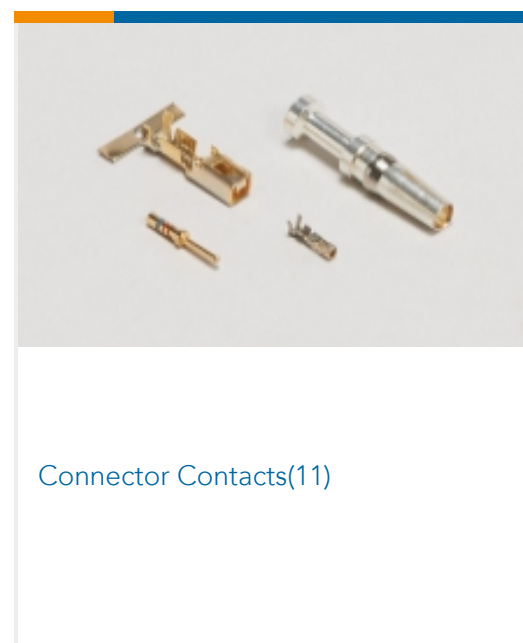
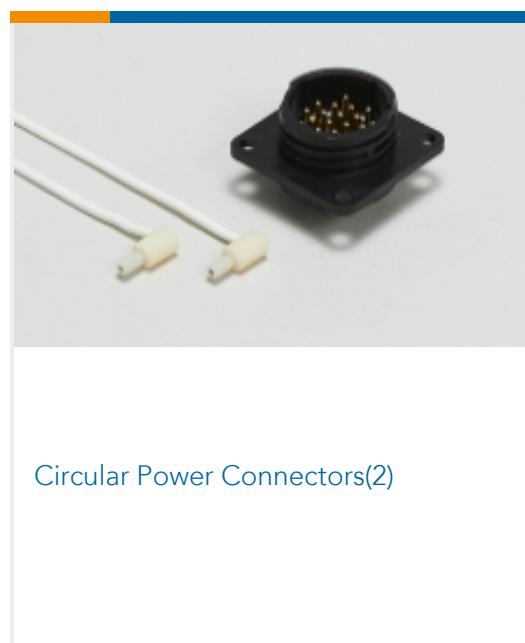



Rectangular Connector Keying Plugs(3)



Rectangular Connector Locking(4)

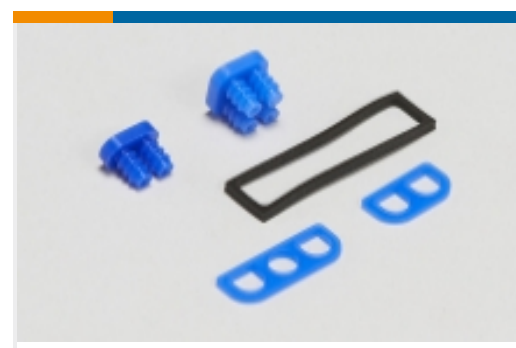

Rectangular Connector Seals(26)



Rectangular Power Connectors(729)

Customers Also Bought

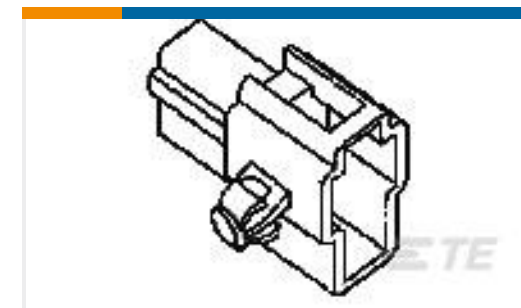
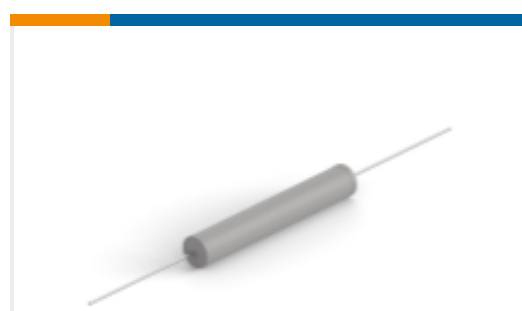
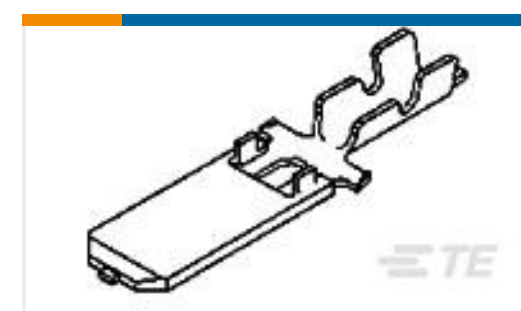
TE Part #350736-1
15P UMNL PLUG HSGTE Part #1-480711-0
15P UMNL CAP HSG NATLTE Part #180351-8
FF 250 REC 4-6MM2 PTBRTE Part #172383-1
FF 250 REC HSG 2P NYLON NAT P/MTE Part #2-2176416-3
9W STD M/OX 5% 430RTE Part #794279-1
12P UMNL INTERFACE SEALTE Part #794273-1
04P UMNL INTERFACE SEALTE Part #170349-1
FF 250 TAB 22-20AWG BR WITHOUT LATCHTE Part #926471-3
1P UNIV MNL ST GEHTE Part #2713376002
SASR-NR504-X-15MM

Documents

Product Drawings

15P UMNL INTERFACE SEAL

English

CAD Files

Customer View Model

ENG_CVM_CVM_794281-1_D.2d_dxf.zip

English

3D PDF



3D

Customer View Model

[ENG_CVM_CVM_794281-1_D.3d_igs.zip](#)

English

Customer View Model

[ENG_CVM_CVM_794281-1_D.3d_stp.zip](#)

English

By downloading the CAD file I accept and agree to the [Terms and Conditions](#) of use.

Datasheets & Catalog Pages

[SOFT_SHELL_PIN_SOCKET_CONNECTORS_STANDARD_DENSITY](#)

English

Product Specifications

[Application Specification](#)

English

[MATE-N-LOK Sealed Universal Connectors](#)

English

Product Environmental Compliance

[Safety Datasheet](#)

English

Instruction Sheets

[Instruction Sheet \(U.S.\)](#)

English