

76829-0006 SHOWN

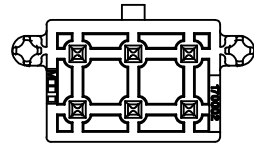
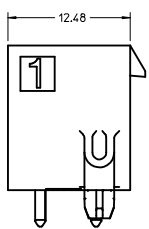
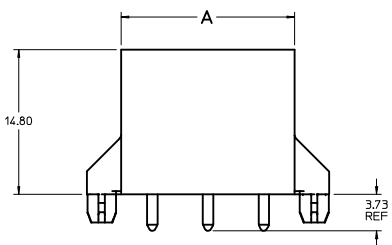
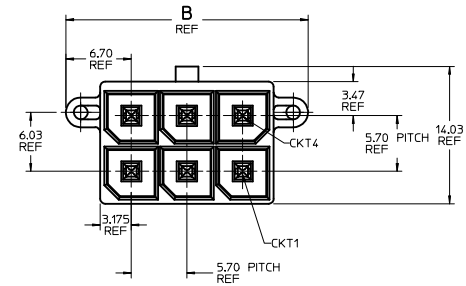

CKT SIZE	PART NO.	PLATING	DIM A	DIM B	DIM C BASIC	DIM D
2	X 76829-0002	TIN	8.35	15.39	12.34	16.39
4	X 76829-0004	TIN	12.05	19.10	16.04	20.10
6	X 76829-0006	TIN	17.75	24.80	21.74	25.80
8	X 76829-0008	TIN	23.45	30.50	27.44	31.50
10	X 76829-0010	TIN	29.15	36.20	33.14	37.20
12	X 76829-0012	TIN	34.85	41.90	38.84	42.90
2	172065-0002	15 GOLD	8.35	15.39	12.34	16.39
4	172065-0004	15 GOLD	12.05	19.10	16.04	20.10
6	172065-0006	15 GOLD	17.75	24.80	21.74	25.80
8	172065-0008	15 GOLD	23.45	30.50	27.44	31.50
10	172065-0010	15 GOLD	29.15	36.20	33.14	37.20
12	172065-0012	15 GOLD	34.85	41.90	38.84	42.90
2	172065-1002	30 GOLD	8.35	15.39	12.34	16.39
4	172065-1004	30 GOLD	12.05	19.10	16.04	20.10
6	172065-1006	30 GOLD	17.75	24.80	21.74	25.80
8	172065-1008	30 GOLD	23.45	30.50	27.44	31.50
10	172065-1010	30 GOLD	29.15	36.20	33.14	37.20
12	172065-1012	30 GOLD	34.85	41.90	38.84	42.90

X = NOT RELEASED

NOTES:

- MATERIAL:
HOUSING LCP, UL94V-0, BLACK.
TERMINAL: HIGH CONDUCTIVITY COPPER.
- TERMINAL PLATING:
(TIN) 1.52 MICROMETER /(60 MICROINCH) MIN REFLOWED MATTE TIN OVER
1.27 MICROMETER /(50 MICROINCH) MIN NICKEL OVERALL.
(15 GOLD) 0.38 MICROMETER /(15 MICROINCH) MIN SELECT GOLD ON CONTACT AREA
2.54 MICROMETER /(100 MICROINCH) MIN SELECT MATTE TIN ON SOLDER AREA
BOTH OVER 1.27 MICROMETER /(50 MICROINCH) MIN NICKEL OVERALL
(30 GOLD) 0.76 MICROMETER /(30 MICROINCH) MIN SELECT GOLD ON CONTACT AREA
2.54 MICROMETER /(100 MICROINCH) MIN SELECT MATTE TIN ON SOLDER AREA
BOTH OVER 1.27 MICROMETER /(50 MICROINCH) MIN NICKEL OVERALL
- PRODUCT SPECIFICATION PS-76823-100.
- PART MATES WITH MOLEX PART NUMBER 170001 AND 171692 SERIES.
- PACKAGING: TRAY PACKED PER MOLEX SPECIFICATION PK-31301-976.
- APPLICATION SPECIFICATION: AS-76823-100
- PARTS CONFORM TO CLASS "B" REQUIREMENTS OF COSMETIC SPECIFICATION PS-45499-002.

UPDATE WITH MODEL IEC NO: UCP2014-3747 DRAWN BY: DRYAN NGUYEN 2014/03/13 CHKO: BELLE 2014/03/13 APPROVED BY: SMITH 2014/03/31 REV: D3	QUALITY SYMBOLS	GENERAL TOLERANCES (UNLESS SPECIFIED)	DIMENSION STYLE	SCALE	DESIGN UNITS	THIRD ANGLE PROJECTION
	▽=0	mm INCH	MM ONLY	4:1	METRIC	
	▽=0	4 PLACES ±0.25	DRAWN BY: MKARADI MAS 2010/10/06	TITLE	MEGA-FIT VERTICAL HEADER ASSY 2-12 CKT TOP LATCH	
	▽=0	3 PLACES ±0.25	CHECKED BY: APATEL 2010/10/06			
	1 PLACE ±0.25	APPROVED BY: APATEL 2012/06/13	MATERIAL NO.	DOCUMENT NO.	SHEET NO.	
	0 PLACE ±0.25	ANGULAR ±1/2°	SEE CHART	SD-76829-0100	1 OF 2	
		DRAFT WHERE APPLICABLE MUST REMAIN WITHIN DIMENSIONS	THIS DRAWING CONTAINS INFORMATION THAT IS PROPRIETARY TO MOLEX INCORPORATED AND SHOULD NOT BE USED WITHOUT WRITTEN PERMISSION			

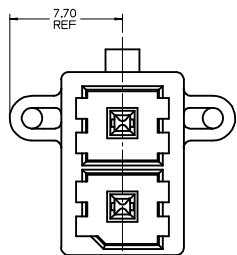

2 CKT

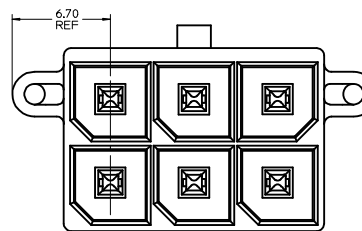

4-12 CKT

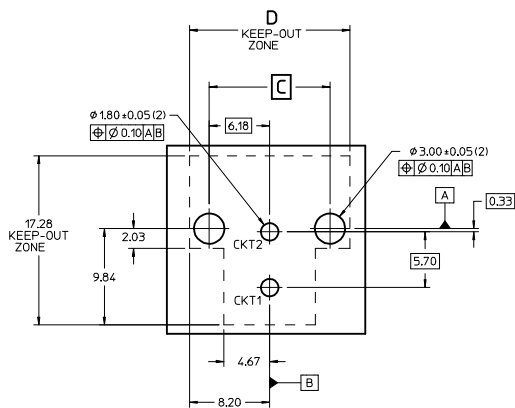

PCB LAYOUT: COMPONENT SIDE
RECOMMENDED PCB THICKNESS: 1.58 MM/.062 IN TO 2.36 MM/.093 IN

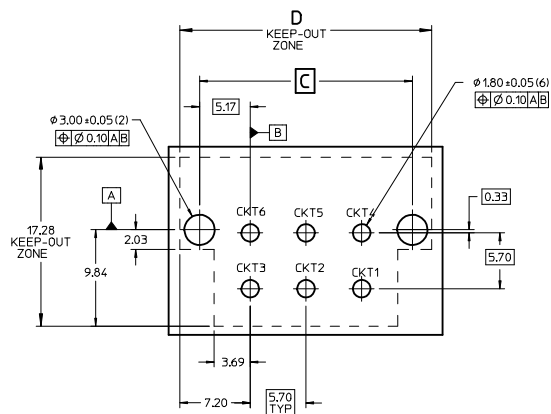

PCB LAYOUT: COMPONENT SIDE
RECOMMENDED PCB THICKNESS: 1.58 MM/.062 IN TO 2.36 MM/.093 IN

SEE SHT 1 SEC NO: UCP2014-3747 DORNAN/GOVEN 2014/03/13 CHYD.BELL 2014/03/13 APPR:FSM/TH 2014/03/21	QUALITY SYMBOLS	GENERAL TOLERANCES (UNLESS SPECIFIED)	DIMENSION STYLE	SCALE	DESIGN UNITS	THIRD ANGLE PROJECTION
	▽=0	mm	MM ONLY	4:1	METRIC	☉
	▽=0	INCH	4 PLACES ± ---	DRAWN BY	DATE	TITLE
	▽=0	ANGULAR ±1/2°	3 PLACES ± ---	MKARADIMAS	2010/10/06	MEGA-FIT
▽=0	DRAFT WHERE APPLICABLE MUST REMAIN WITHIN DIMENSIONS	2 PLACES ± 0.25	CHECKED BY	DATE	2-12 CKT TOP LATCH	
		1 PLACE ± ---	APATEL	2010/10/06		
		0 PLACE ± ---	APPROVED BY	DATE		
			APATEL	2012/06/13		
			MATERIAL NO.	DOCUMENT NO.		
			SEE CHART	SD-76829-0100		
			SIZE			
			D			