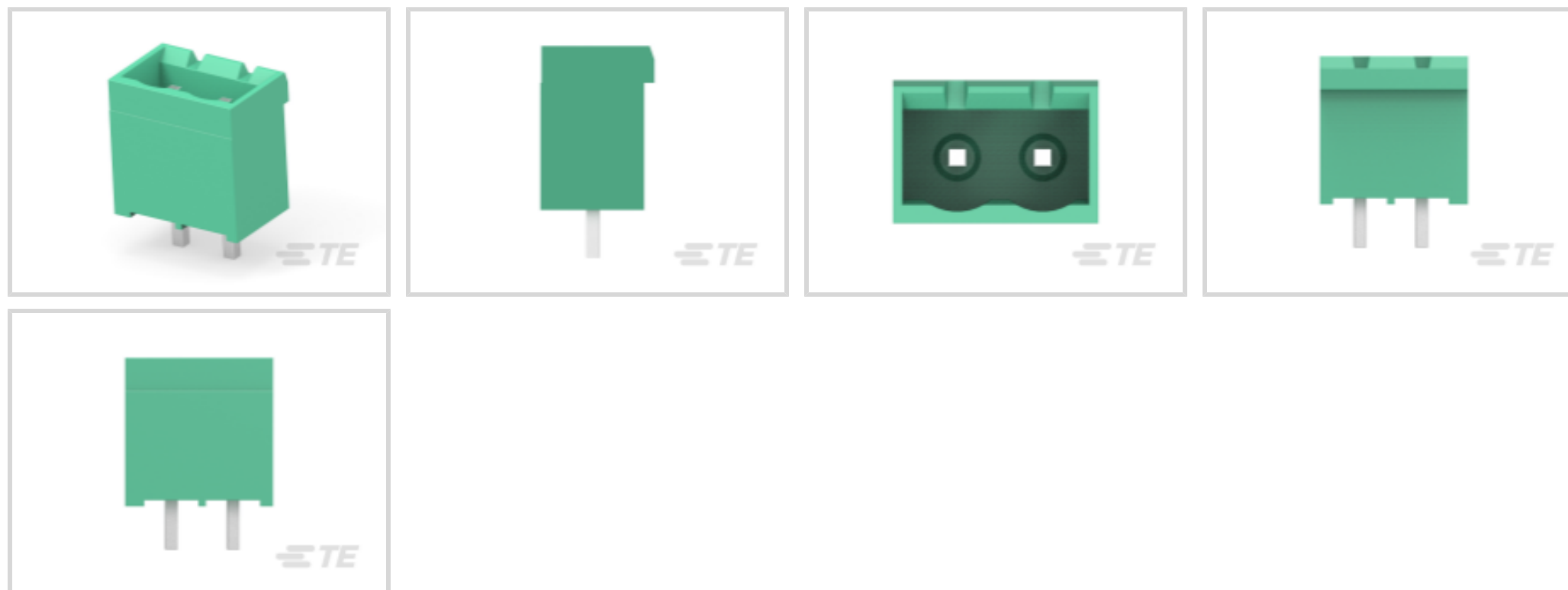

## Buchanan

TE Internal #: 796642-2

PCB Terminal Blocks, Header, Wire-to-Board, 2 Position, .197 in [5 mm] Centerline, 1 Row, 30 – 12 AWG Wire Size, .05 – 3 mm<sup>2</sup> Wire Size, 15 A, 300 VAC

[View on TE.com >](#)
[Connectors > Terminal Blocks & Strips > PCB Terminal Blocks](#)
Terminal Block Connector Type: **Header**Connector System: **Wire-to-Board**Number of Positions: **2**Centerline (Pitch): **5 mm [ .197 in ]**Number of Rows: **1**

## Features

### Product Type Features

Block Type	PCB Mount
Header Type	Fully Shrouded
Terminal Block Connector Type	Header
Connector System	Wire-to-Board
Connector & Contact Terminates To	Printed Circuit Board

### Configuration Features

Threaded Flange	Without
Closed End	With
Number of Positions	2
Number of Rows	1

### Electrical Characteristics

Current Rating (Max)	15 A
Voltage Rating	300 VAC

### Body Features



Interlock	Without
-----------	---------

### Contact Features

Contact Mating Area Plating Material	Tin
Contact Mount	Through Hole
Contact Base Material	Copper Alloy
Contact Current Rating (Max)	15 A

### Mechanical Attachment

Screwless Terminal Block	No
Mounting Angle	Vertical
Screw Flange	Without
Connector Mounting Type	Board Mount

### Housing Features

Housing Color	Green
Housing Material	PA 66
Centerline (Pitch)	5 mm [.197 in]

### Dimensions

PCB Tail Length	3.5 mm [.138 in]
Wire Size	.05 – 3 mm <sup>2</sup>

### Usage Conditions

Operating Temperature Range	-40 – 105 °C [-40 – 221 °F]
-----------------------------	-----------------------------

### Operation/Application

Circuit Application	Power & Signal
---------------------	----------------

### Identification Marking

Marking Color	White
---------------	-------

### Packaging Features

Packaging Method	Box
Packaging Quantity	300

### Product Compliance

For compliance documentation, visit the product page on [TE.com](https://www.te.com)>

EU RoHS Directive 2011/65/EU	Compliant
------------------------------	-----------

EU ELV Directive 2000/53/EC

Compliant

China RoHS 2 Directive MIIT Order No 32, 2016

No Restricted Materials Above Threshold

EU REACH Regulation (EC) No. 1907/2006

Current ECHA Candidate List: JUNE 2022 (224)

Candidate List Declared Against: JUNE 2022 (224)

Does not contain REACH SVHC

Halogen Content

Low Halogen - Br, Cl, F, I &lt; 900 ppm per homogenous material. Also BFR/CFR/PVC Free

Solder Process Capability

Wave solder capable to 240°C

## Product Compliance Disclaimer

This information is provided based on reasonable inquiry of our suppliers and represents our current actual knowledge based on the information they provided. This information is subject to change. The part numbers that TE has identified as EU RoHS compliant have a maximum concentration of 0.1% by weight in homogenous materials for lead, hexavalent chromium, mercury, PBB, PBDE, DBP, BBP, DEHP, DIBP, and 0.01% for cadmium, or qualify for an exemption to these limits as defined in the Annexes of Directive 2011/65/EU (RoHS2). Finished electrical and electronic equipment products will be CE marked as required by Directive 2011/65/EU. Components may not be CE marked. Additionally, the part numbers that TE has identified as EU ELV compliant have a maximum concentration of 0.1% by weight in homogenous materials for lead, hexavalent chromium, and mercury, and 0.01% for cadmium, or qualify for an exemption to these limits as defined in the Annexes of Directive 2000/53/EC (ELV). Regarding the REACH Regulation, the information TE provides on SVHC in articles for this part number is based on the latest European Chemicals Agency (ECHA) 'Guidance on requirements for substances in articles' posted at this URL: <https://echa.europa.eu/guidance-documents/guidance-on-reach>

## Compatible Parts



TE Part # 284040-2  
TERMI-BLOK VERTICAL PLUG STACK



TE Part # 284046-2  
TERMI-BLOK VERTICAL PLUG STACK



TE Part # 1546118-2  
2POS.5MM VERT.PLUG LH BLCK

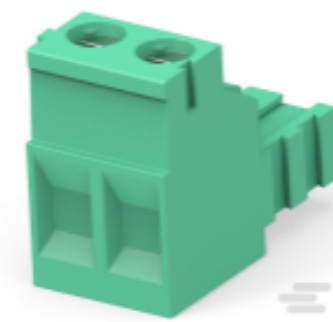

TE Part # 282805-2  
TERMI-BLOK PLUG STACKING 2POS.



TE Part # 1776146-2  
2P TERMI-BLOK HDR,HIGH TEMP

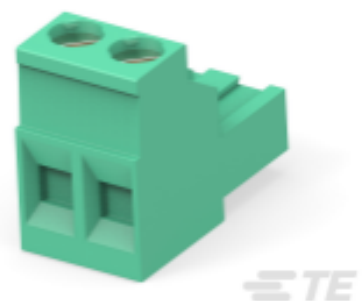

TE Part # 796640-2  
2 POS 5.0 MM R/A PLUG,TRM BLK



TE Part # 796641-2  
2 POS 5.0 MM R/A PLUG,TRM BLK

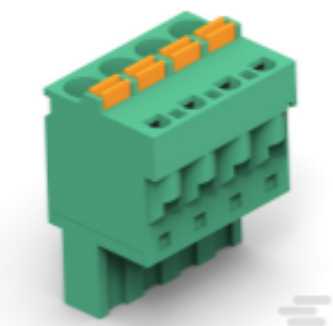

TE Part # 1546557-2  
2P,SCREWLESS CLIP PLUG,5.0MM

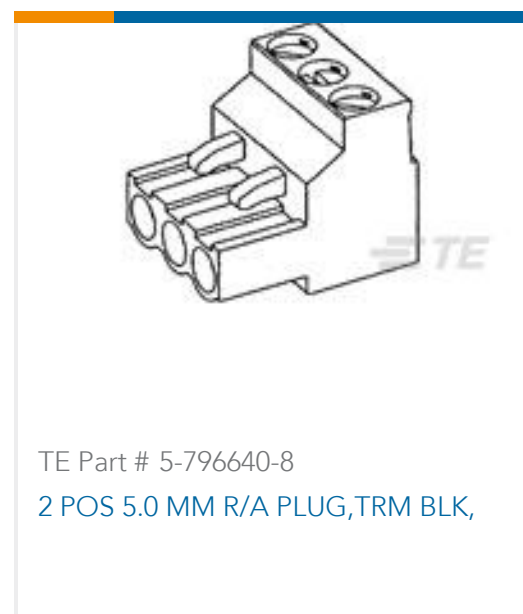

## Customers Also Bought

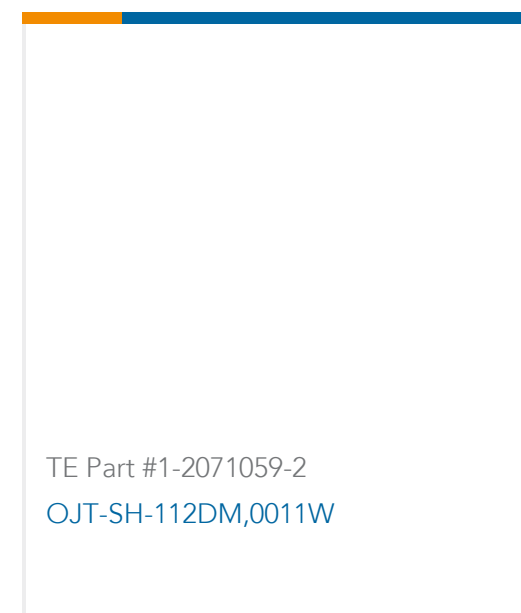
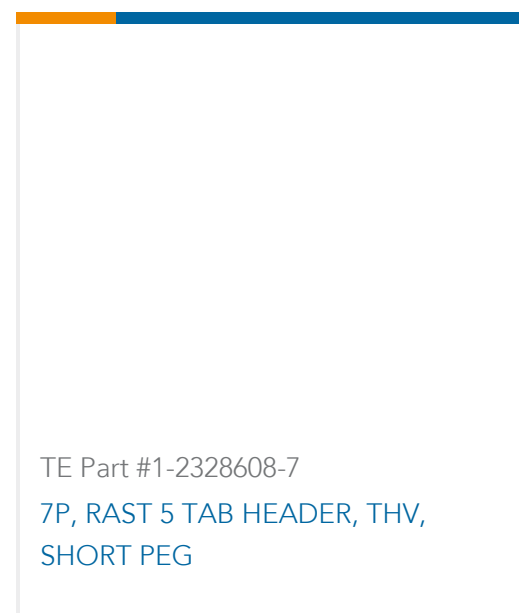

## Documents

### Product Drawings

[2POS 5.0MM CE VRT HDR,TRM BLK](#)

English

### CAD Files

[3D PDF](#)

3D

Customer View Model

[ENG\\_CVM\\_CVM\\_796642-2\\_B.2d\\_dxf.zip](#)

English

Customer View Model

[ENG\\_CVM\\_CVM\\_796642-2\\_B.3d\\_igs.zip](#)

English

Customer View Model

[ENG\\_CVM\\_CVM\\_796642-2\\_B.3d\\_stp.zip](#)

English

[3D PDF](#)

English

Customer View Model

[ENG\\_CVM\\_796642-2\\_C3.3d\\_igs.zip](#)

English

Customer View Model

[ENG\\_CVM\\_796642-2\\_C3.3d\\_stp.zip](#)

English

Customer View Model



[ENG\\_CVM\\_796642-2\\_C3.2d\\_dxf.zip](#)

English

By downloading the CAD file I accept and agree to the [Terms and Conditions](#) of use.

---

### Datasheets & Catalog Pages

[Eurostyle Terminal Blocks Focus Product Stock List](#)

English

[BUCHANAN TERMINAL BLOCKS CATALOG - EUROSTYLE TERMINAL BLOCKS](#)

English

[BUCHANAN PCB TERMINAL BLOCKS](#)

English

[1-1773458-1\\_EURO\\_STYLE\\_TERMINAL\\_BLOCKS\\_ORG](#)

English

---

### Product Specifications

[Application Specification](#)

English

---

### Product Environmental Compliance

[TE Material Declaration](#)

English