

776164-4 ✓ ACTIVE

AMP | AMPSEAL

TE Internal #: 776164-4

Housing for Female Terminals, Wire-to-Board, 35 Position, .157 in [4 mm] Centerline, Sealable, Gray, Power & Signal, AMPSEAL

[View on TE.com >](#)



Connectors > Automotive Connectors > Connector Housings > AMPSEAL Receptacle Housings

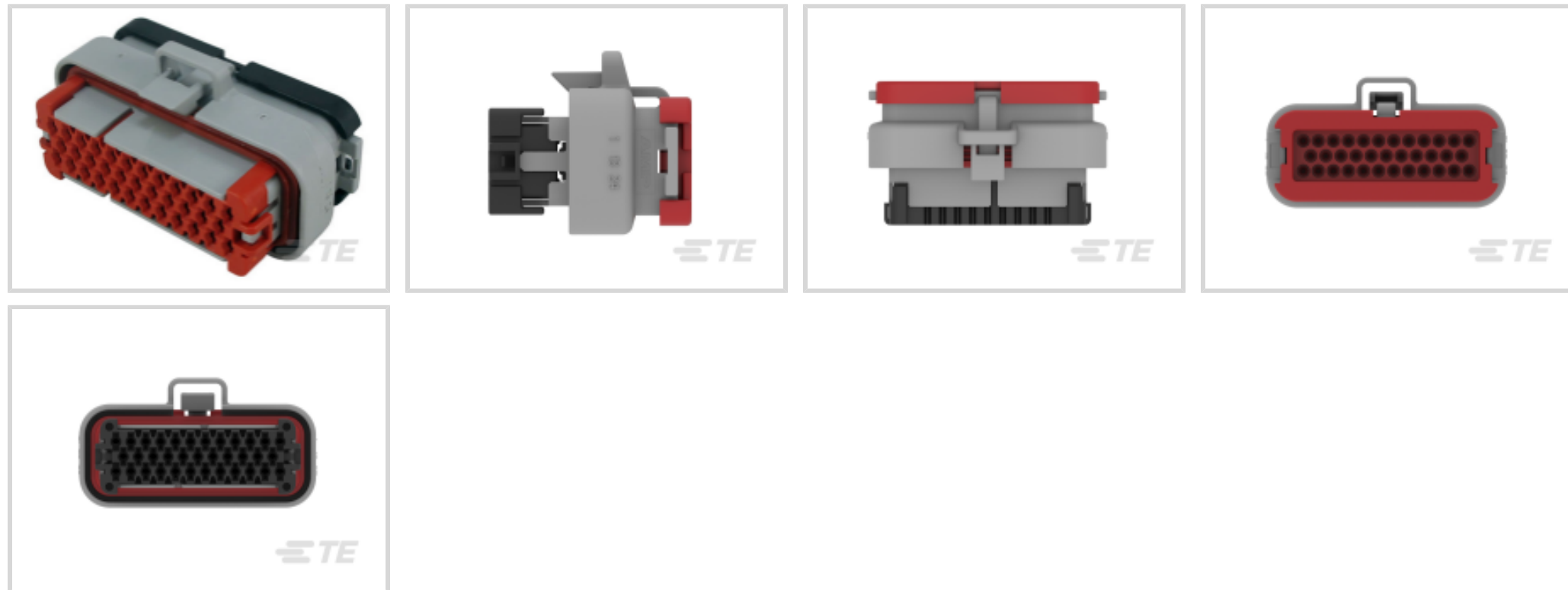

Connector & Housing Type: **Housing for Female Terminals**

Mating Pin Diameter: **1.3 mm [ .051 in ]**

Connector System: **Wire-to-Board**

Number of Positions: **35**

Centerline (Pitch): **4 mm [ .157 in ]**

[All AMPSEAL Receptacle Housings \(31\)](#)

## Features

### Product Type Features

Connector & Housing Shape	Rectangular
Connector & Housing Type	Housing for Female Terminals
Connector System	Wire-to-Board
Sealable	Yes
Hybrid Connector	No
Primary Locking Feature	Integrated in Housing

### Configuration Features

Number of Positions	35
Number of Rows	3

### Electrical Characteristics

Operating Voltage	250 VAC
Nominal Voltage Architecture	250 V

### Body Features



Cable Exit Angle	180°
Body Material	Other
Primary Product Color	Gray
Connector Code	4

#### Contact Features

Contact Size	1.3mm
Contact Type	Socket
Mating Pin Diameter	1.3 mm[.051 in]
Contact Current Rating (Max)	17 A

#### Mechanical Attachment

Mounting Feature	Without
Terminal Position Assurance	Yes
Strain Relief	Add By Accessory
Mating Alignment Type	Keyed
Mating Alignment	With
Connector Mounting Type	Cable Mount (Free-Hanging)

#### Housing Features

Centerline (Pitch)	4 mm[.157 in]
--------------------	---------------

#### Dimensions

Product Width	33.6 mm[1.323 in]
Product Length	63.4 mm[2.496 in]
Product Height	34.6 mm[1.362 in]
Row-to-Row Spacing	4 mm[.157 in]

#### Usage Conditions

Operating Temperature (Max)	105 °C[221 °F]
Operating Temperature Range	0 – 105 °C[-40 – 221 °F]

#### Operation/Application

Circuit Application	Power & Signal
---------------------	----------------

#### Industry Standards

Degree of Protection	IP67, IP69K
UL Flammability Rating	UL 94V-0

#### Packaging Features



Packaging Quantity	140
Packaging Method	Box & Tray

### Other

Serviceable	Yes
Connector Position Assurance Capable	Yes

## Product Compliance

[For compliance documentation, visit the product page on TE.com>](#)

EU RoHS Directive 2011/65/EU	Compliant
EU ELV Directive 2000/53/EC	Compliant
China RoHS 2 Directive MIIT Order No 32, 2016	No Restricted Materials Above Threshold
EU REACH Regulation (EC) No. 1907/2006	Current ECHA Candidate List: JUNE 2022 (224) Candidate List Declared Against: JUNE 2022 (224) Does not contain REACH SVHC
Halogen Content	Not Low Halogen - contains Br or Cl > 900 ppm.
Solder Process Capability	Not applicable for solder process capability

#### Product Compliance Disclaimer

This information is provided based on reasonable inquiry of our suppliers and represents our current actual knowledge based on the information they provided. This information is subject to change. The part numbers that TE has identified as EU RoHS compliant have a maximum concentration of 0.1% by weight in homogenous materials for lead, hexavalent chromium, mercury, PBB, PBDE, DBP, BBP, DEHP, DIBP, and 0.01% for cadmium, or qualify for an exemption to these limits as defined in the Annexes of Directive 2011/65/EU (RoHS2). Finished electrical and electronic equipment products will be CE marked as required by Directive 2011/65/EU. Components may not be CE marked. Additionally, the part numbers that TE has identified as EU ELV compliant have a maximum concentration of 0.1% by weight in homogenous materials for lead, hexavalent chromium, and mercury, and 0.01% for cadmium, or qualify for an exemption to these limits as defined in the Annexes of Directive 2000/53/EC (ELV). Regarding the REACH Regulation, the information TE provides on SVHC in articles for this part number is based on the latest European Chemicals Agency (ECHA) 'Guidance on requirements for substances in articles' posted at this URL: <https://echa.europa.eu/guidance-documents/guidance-on-reach>

## Compatible Parts



Also in the Series | AMPSEAL

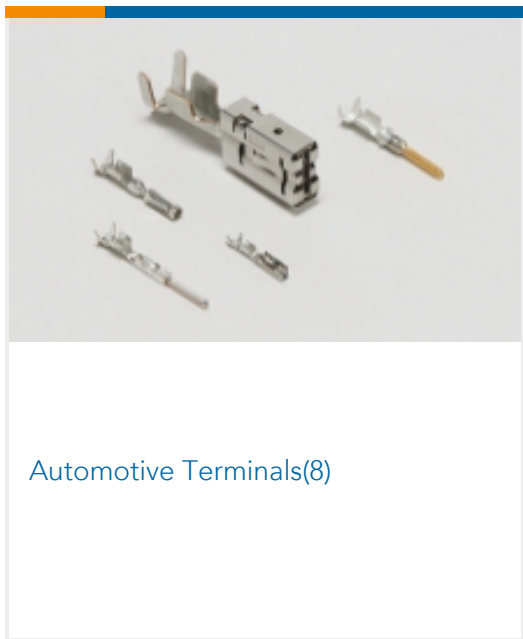
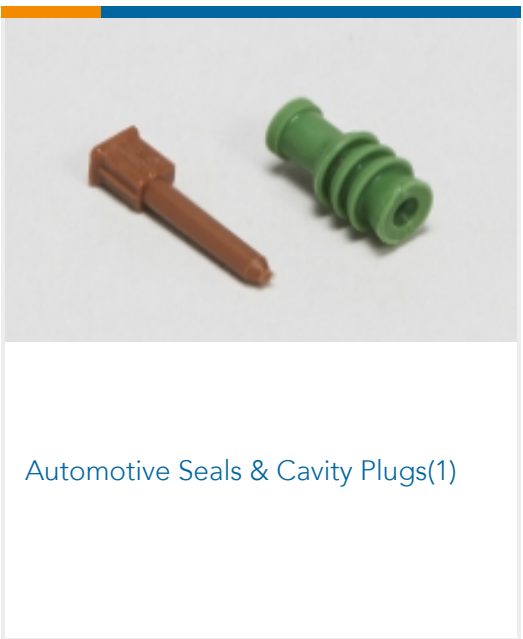
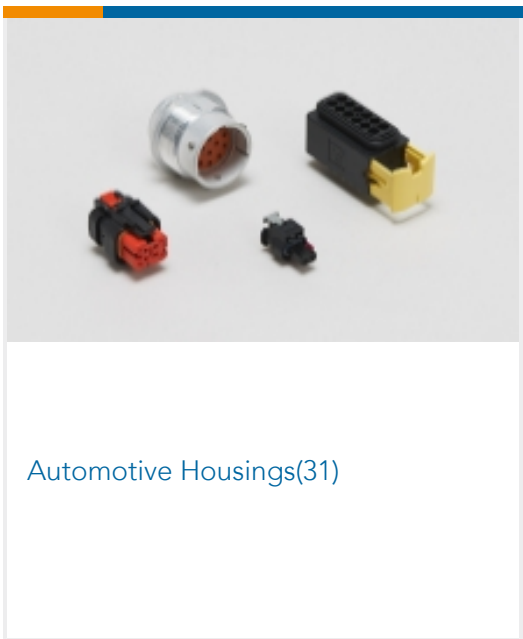
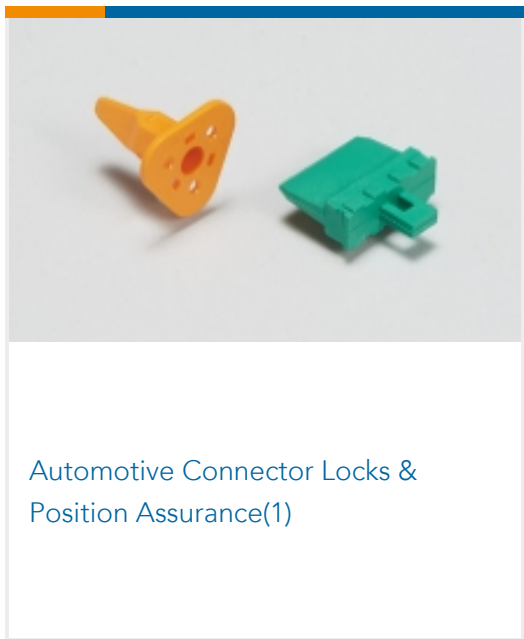
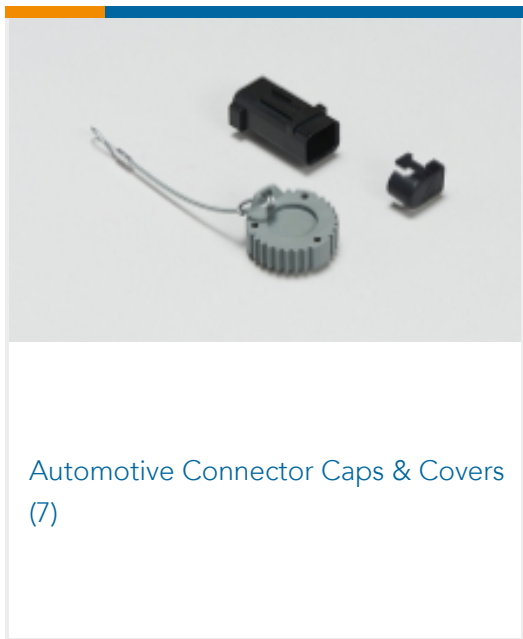

Customers Also Bought





TE Part #5677576049  
RNF-3000-6/2-0-40MM

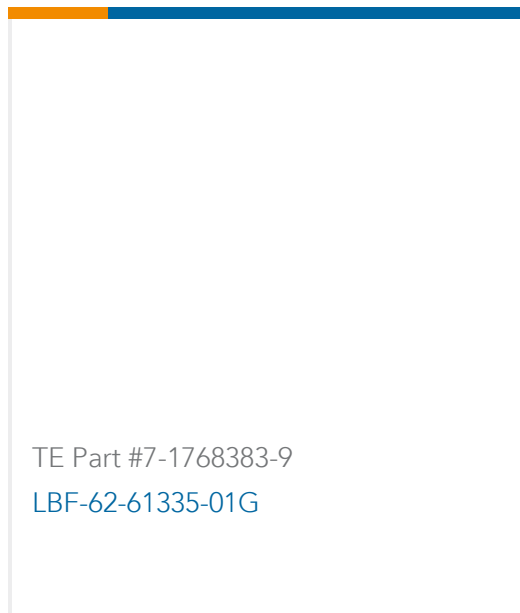

TE Part #7-1768383-9  
LBF-62-61335-01G

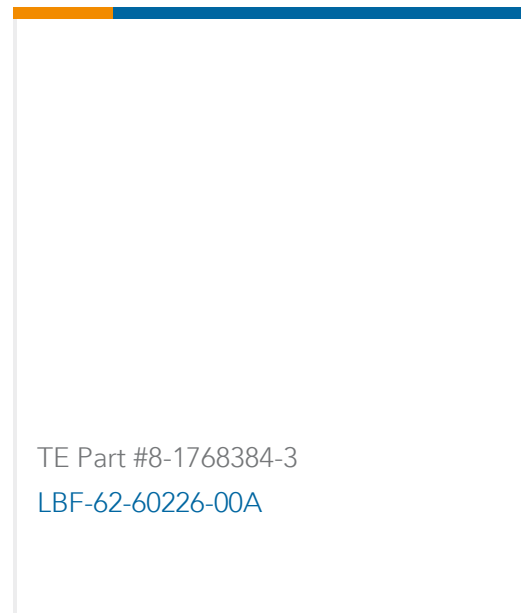

TE Part #8-1768384-3  
LBF-62-60226-00A

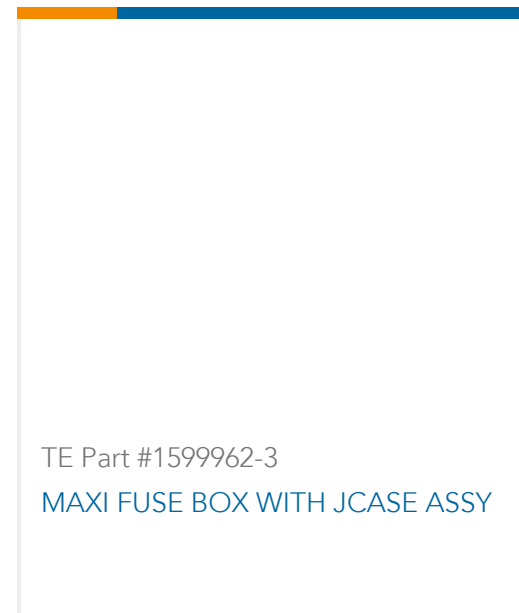

TE Part #1599962-3  
MAXI FUSE BOX WITH JCASE ASSY

## Documents

### Product Drawings

[35POS,AMPSEAL,SOC HSG ASSY,SLD,COD 4](#)

English

### CAD Files

Customer View Model

[ENG\\_CVM\\_CVM\\_776164-4\\_F.2d\\_dxf.zip](#)

English

[3D PDF](#)

3D

Customer View Model

[ENG\\_CVM\\_CVM\\_776164-4\\_F.3d\\_igs.zip](#)

English

Customer View Model

[ENG\\_CVM\\_CVM\\_776164-4\\_F.3d\\_stp.zip](#)

English

By downloading the CAD file I accept and agree to the [Terms and Conditions](#) of use.

### Datasheets & Catalog Pages

[AMPSEAL Connector Catalog](#)

English

[ICT Terminals and Connectors Catalogue](#)

English

### Product Specifications

[Application Specification](#)

English

### Instruction Sheets

[Instruction Sheet \(U.S.\)](#)

English

### Agency Approvals

[UL Report](#)

English