

9-1394050-1 ✓ ACTIVE

AMP | LEAVYSEAL

TE Internal #: 9-1394050-1

Automotive Connector Caps & Covers, Cover - Cable Exit, Cable Exit Angle 90° (Right Angle), Black, PA GF, Wire-to-Board / Wire-to-Device, LEAVYSEAL

[View on TE.com >](#)



Connectors > Automotive Connectors > Connector Accessories > Connector Caps & Covers > LEAVYSEAL BACKSHELLS

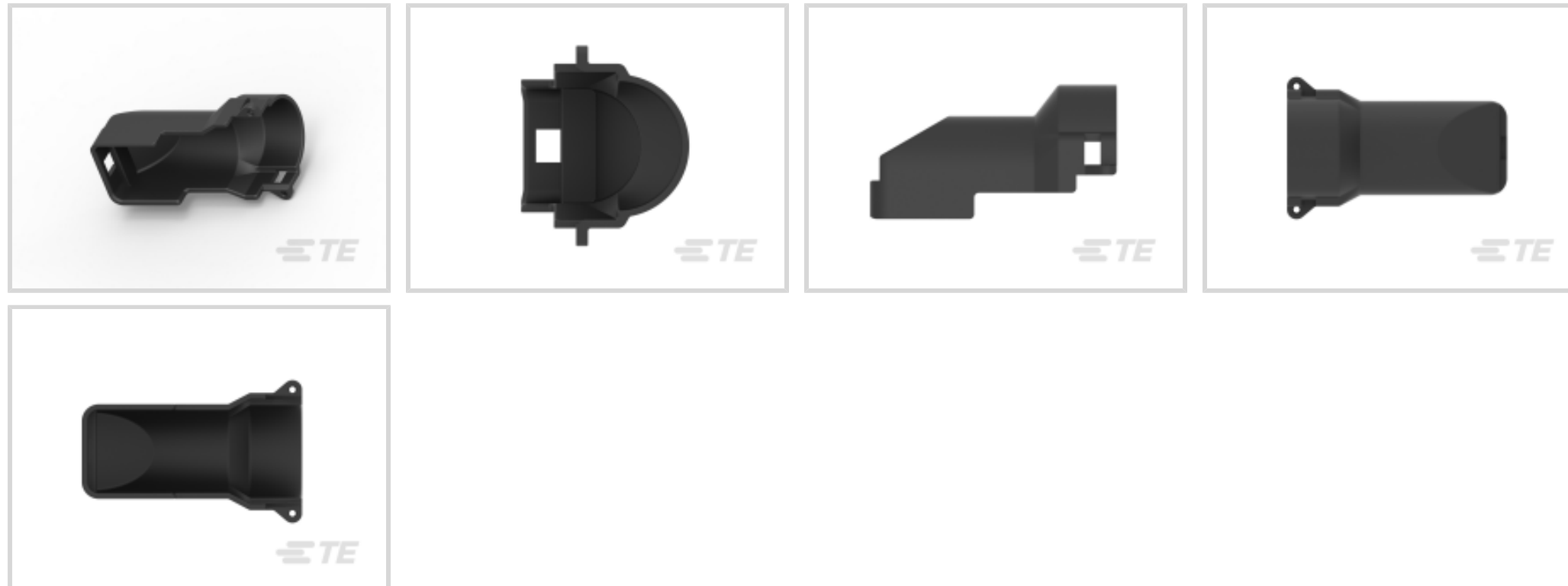

Protection & Strain Relief Accessory Type: **Cover - Cable Exit**

Cable Exit Angle: **90° (Right Angle)**

Strain Relief: **With**

Primary Product Color: **Black**

Primary Product Material: **PA GF**

[All LEAVYSEAL BACKSHELLS \(13\)](#)

## Features

### Product Type Features

Protection & Strain Relief Accessory Type	Cover - Cable Exit
Connector System	Wire-to-Board, Wire-to-Device

### Configuration Features

Number of Positions	21
---------------------	----

### Body Features

Cable Exit Angle	90° (Right Angle)
Primary Product Color	Black
Primary Product Material	PA GF

### Mechanical Attachment

Strain Relief	With
---------------	------

### Dimensions

Compatible Cable Bundle Diameter Range	21 mm[.827 in]
--	----------------



### Usage Conditions

Compatible With Connector Style	Housing For Female Terminals
Operating Temperature (Max)	70 °C, 75 °C, 80 °C, 85 °C, 90 °C, 100 °C, 105 °C, 110 °C, 120 °C [158 °F] [167 °F] [176 °F] [185 °F] [194 °F] [212 °F] [221 °F] [230 °F] [248 °F]
Operating Temperature Range	-40 – 120 °C [-40 – 248 °F]

### Industry Standards

UL Flammability Rating	UL 94HB
------------------------	---------

### Packaging Features

Packaging Quantity	1000
Packaging Method	Box

### Other

Serviceable	Yes
-------------	-----

### Product Compliance

[For compliance documentation, visit the product page on TE.com>](#)

EU RoHS Directive 2011/65/EU	Compliant
EU ELV Directive 2000/53/EC	Compliant
China RoHS 2 Directive MIIT Order No 32, 2016	No Restricted Materials Above Threshold
EU REACH Regulation (EC) No. 1907/2006	Current ECHA Candidate List: JUNE 2022 (224) Candidate List Declared Against: JUL 2021 (219) SVHC > Threshold: Not Yet Reviewed
Halogen Content	Low Halogen - Br, Cl, F, I < 900 ppm per homogenous material. Also BFR/CFR/PVC Free
Solder Process Capability	Not applicable for solder process capability

#### Product Compliance Disclaimer

This information is provided based on reasonable inquiry of our suppliers and represents our current actual knowledge based on the information they provided. This information is subject to change. The part numbers that TE has identified as EU RoHS compliant have a maximum concentration of 0.1% by weight in homogenous materials for lead, hexavalent chromium, mercury, PBB, PBDE, DBP, BBP, DEHP, DIBP, and 0.01% for cadmium, or qualify for an exemption to these limits as defined in the Annexes of Directive 2011/65/EU (RoHS2). Finished electrical and electronic equipment products will be CE marked as required by Directive 2011/65/EU. Components may not be CE marked. Additionally, the part numbers that TE has identified as EU ELV compliant have a maximum concentration of 0.1% by weight in homogenous materials for lead, hexavalent chromium, and mercury, and 0.01% for cadmium, or qualify for an exemption to these limits as defined in the Annexes of Directive 2000/53/EC (ELV). Regarding the REACH Regulation, the information TE provides

on SVHC in articles for this part number is based on the latest European Chemicals Agency (ECHA) 'Guidance on requirements for substances in articles' posted at this URL: <https://echa.europa.eu/guidance-documents/guidance-on-reach>

### Compatible Parts



TE Part # CAT-L489-CH8172  
LEAVYSEAL HOUSINGS

### Also in the Series | LEAVYSEAL



Automotive Connector Caps & Covers (16)



Automotive Housings(64)



Insertion & Extraction Tools(5)



Other Automotive Connector Accessories(15)



PCB Headers & Receptacles(13)

### Customers Also Bought



TE Part #2112233-1  
LEAVYSEAL BACKSHELLS



TE Part #2176089-9  
RP 1J 0.166W 12K7 0.1% 25PPM 1K RL



TE Part #8-2176087-6  
RP 1J 0.166W 536R 0.1% 25PPM 1K RL



TE Part #7829644001  
CGPT-19/9.5-2-FSP

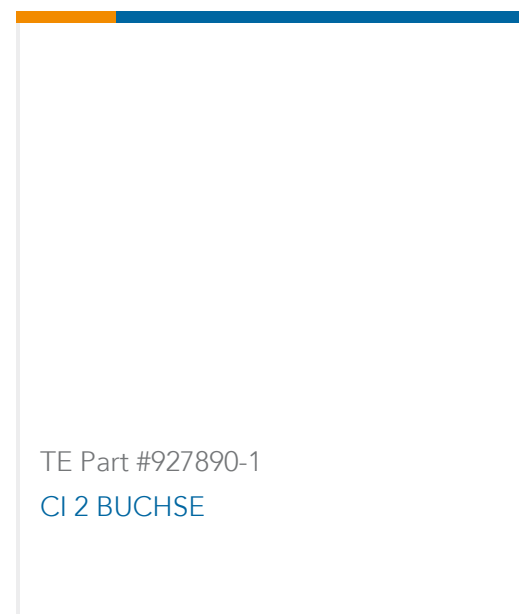
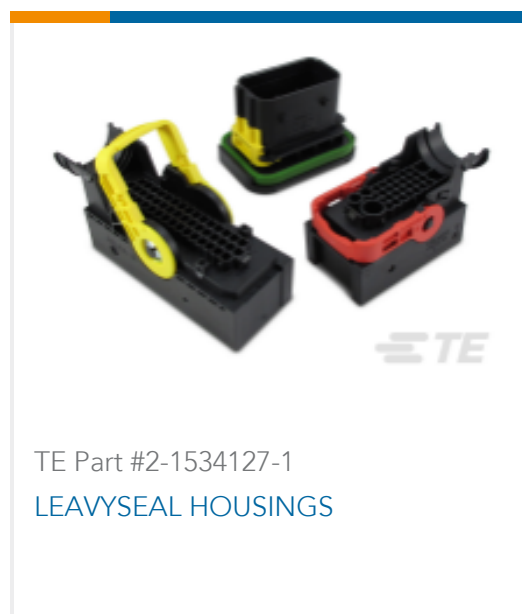

## Documents

### Product Drawings

#### COVER F.21P REC-HSG

English

### CAD Files

#### 3D PDF

3D

#### Customer View Model

[ENG\\_CVM\\_CVM\\_9-1394050-1\\_B.2d\\_dxf.zip](#)

English

#### Customer View Model

[ENG\\_CVM\\_CVM\\_9-1394050-1\\_B.3d\\_igs.zip](#)

English

#### Customer View Model

[ENG\\_CVM\\_CVM\\_9-1394050-1\\_B.3d\\_stp.zip](#)

English

By downloading the CAD file I accept and agree to the [Terms and Conditions](#) of use.

### Datasheets & Catalog Pages

#### ICT Terminals and Connectors Catalogue

English

#### CONNECTOR SELECTOR

English

### Product Specifications

#### Application Specification

German

### Product Environmental Compliance

#### MD\_9-1394050-1\_01302017631\_dmtec

English

#### MD\_9-1394050-1\_01302017631\_dmtec

English