



Connectors > Power Connectors > Rectangular Power > Rectangular Power Connectors



Rectangular Power Connector Type: **Housing**

Connector & Housing Type: **Receptacle**

Connector System: **Wire-to-Wire**

Number of Positions: **2**

Centerline (Pitch): **6.3 mm [.248 in]**

Features

Product Type Features

Rectangular Power Connector Type	Housing
Connector & Housing Type	Receptacle
Connector System	Wire-to-Wire
Sealable	No
Connector & Contact Terminates To	Wire & Cable

Configuration Features

Number of Positions	2
Number of Signal Positions	2
Number of Rows	1

Electrical Characteristics

Operating Voltage	600 VAC
-------------------	---------

Contact Features

Contact Layout	Inline
Contact Retention Within Housing	Without



Contact Type	Socket
--------------	--------

Termination Features

Termination Method to Wire & Cable	Crimp
------------------------------------	-------

Mechanical Attachment

Connector Mounting Type	Cable Mount (Free-Hanging)
-------------------------	----------------------------

Housing Features

Centerline (Pitch)	6.3 mm [.248 in]
--------------------	------------------

Housing Color	Natural
---------------	---------

Housing Material	Nylon
------------------	-------

Usage Conditions

Operating Temperature Range	-55 – 105 °C [-67 – 221 °F]
-----------------------------	-----------------------------

Operation/Application

Circuit Application	Power & Signal
---------------------	----------------

Industry Standards

CSA Rating	Certified
------------	-----------

UL Flammability Rating	UL 94V-0
------------------------	----------

Glow Wire Rating	Standard Part - Not Glow Wire
------------------	-------------------------------

UL Rating	Recognized
-----------	------------

Agency/Standard Number	E28476
------------------------	--------

CSA File Number	LR7189
-----------------	--------

Agency/Standard	CSA, UL
-----------------	---------

Packaging Features

Packaging Method	Package
------------------	---------

Packaging Quantity	1
--------------------	---

Other

For Use With	Plug Housing
--------------	--------------

Product Compliance

[For compliance documentation, visit the product page on TE.com>](#)

EU RoHS Directive 2011/65/EU	Compliant
------------------------------	-----------

EU ELV Directive 2000/53/EC	Compliant
-----------------------------	-----------



China RoHS 2 Directive MIIT Order No 32, 2016	No Restricted Materials Above Threshold
EU REACH Regulation (EC) No. 1907/2006	Current ECHA Candidate List: JUNE 2022 (224) Candidate List Declared Against: JUNE 2022 (224) Does not contain REACH SVHC
Halogen Content	Low Halogen - Br, Cl, F, I < 900 ppm per homogenous material. Also BFR/CFR/PVC Free
Solder Process Capability	Not applicable for solder process capability

Product Compliance Disclaimer

This information is provided based on reasonable inquiry of our suppliers and represents our current actual knowledge based on the information they provided. This information is subject to change. The part numbers that TE has identified as EU RoHS compliant have a maximum concentration of 0.1% by weight in homogenous materials for lead, hexavalent chromium, mercury, PBB, PBDE, DBP, BBP, DEHP, DIBP, and 0.01% for cadmium, or qualify for an exemption to these limits as defined in the Annexes of Directive 2011/65/EU (RoHS2). Finished electrical and electronic equipment products will be CE marked as required by Directive 2011/65/EU. Components may not be CE marked. Additionally, the part numbers that TE has identified as EU ELV compliant have a maximum concentration of 0.1% by weight in homogenous materials for lead, hexavalent chromium, and mercury, and 0.01% for cadmium, or qualify for an exemption to these limits as defined in the Annexes of Directive 2000/53/EC (ELV). Regarding the REACH Regulation, the information TE provides on SVHC in articles for this part number is based on the latest European Chemicals Agency (ECHA) 'Guidance on requirements for substances in articles' posted at this URL: <https://echa.europa.eu/guidance-documents/guidance-on-reach>

Compatible Parts

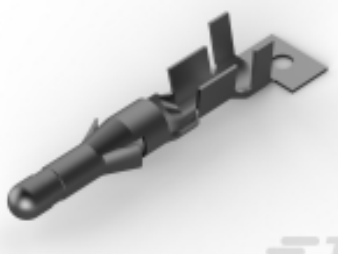
 <p>TE Part # 770147-1 .093 CP&S PIN PTPBR LP 24-18</p>	 <p>TE Part # 770068-1 02P .093 COMM P&S PLUG .248CL</p>	 <p>TE Part # 770069-1 02P .093 COMM P&S PLUG .248CL</p>	 <p>TE Part # 350416-1 .093 COMM P&S PIN 14-20 PTPBR</p>
 <p>TE Part # 770529-1 .093 COMM P&S SOK 14-20 PTPBR</p>	 <p>TE Part # 770530-1 .093 COMM P&S PIN 14-20 PTPBR</p>	 <p>TE Part # 350415-1 .093 COMM P&S SOK 14-20 PTPBR</p>	 <p>TE Part # 350418-1 .093 COMM P&S PIN 18-24 PTPBR</p>



Also in the Series | Commercial Pin and Socket Connectors

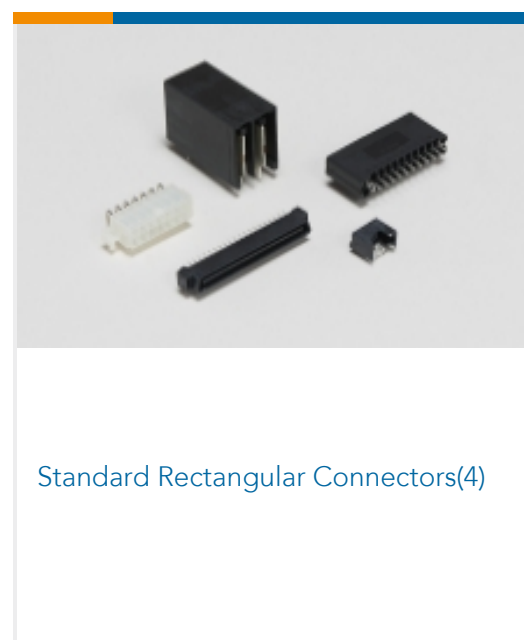
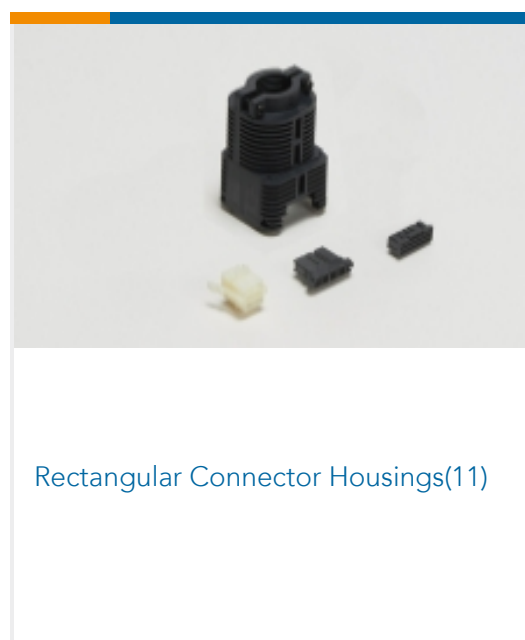
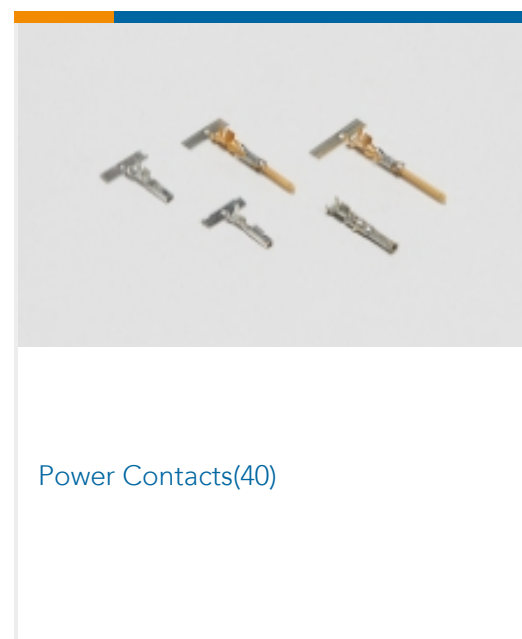
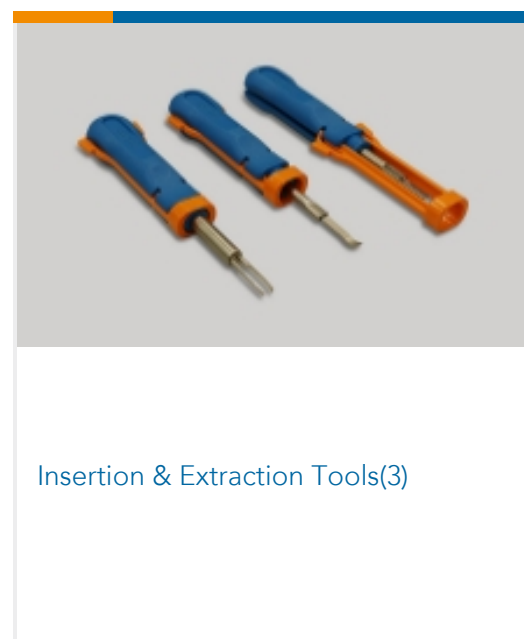
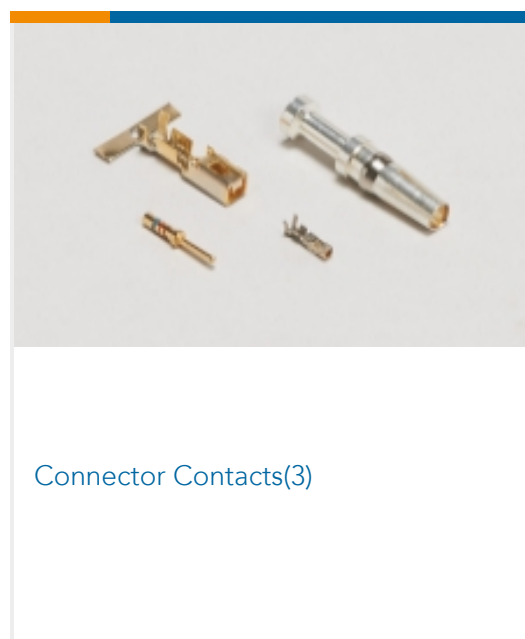

Customers Also Bought



TE Part #440133-2
2.5MM,HSG,2POS

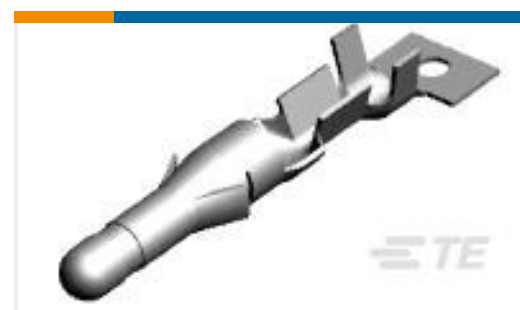

TE Part #770147-1
.093 CP&S PIN PTPBR LP 24-18



TE Part #770074-1
03P .093 COMM P&S PLUG HSG



TE Part #770146-1
.093 CP&S SOK PTPBR LP 24-18



TE Part #770966-1
02P MINI UMNL R/A HDR ASSY SN

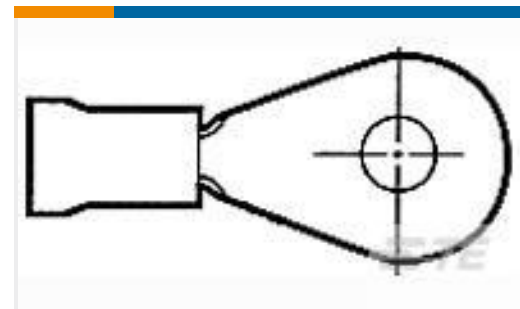

TE Part #55621-2
TERMINAL R PG 8 1/4



TE Part #440053-2
2.5MM,HDR,2POS,R/A

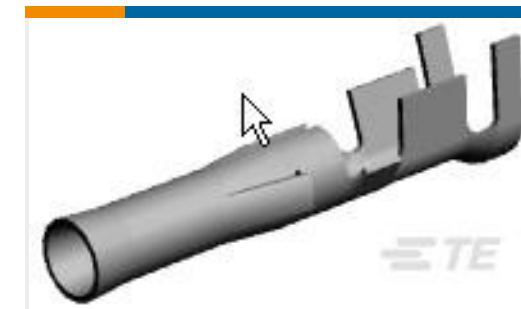

TE Part #770144-1
.093 CP&S SOK PTPBR L/P 20-14



TE Part #770075-1
04P .093 COMM P&S RECPT HSG



TE Part #180900-5
FF 250 REC HSG 4P NYLON BLACK

Documents

Product Drawings

[02P .093 COMM P&S RECPT .248CL](#)

English

CAD Files

[3D PDF](#)

3D

Customer View Model

[ENG_CVM_CVM_770065-1_U.2d_dxf.zip](#)

English

Customer View Model

[ENG_CVM_CVM_770065-1_U.3d_igs.zip](#)

English

Customer View Model

[ENG_CVM_CVM_770065-1_U.3d_stp.zip](#)

English

By downloading the CAD file I accept and agree to the [Terms and Conditions](#) of use.

Datasheets & Catalog Pages



[SOFT_SHELL_PIN_SOCKET_CONNECTORS_STANDARD_DENSITY](#)

English

[Product Specifications](#)

[Application Specification](#)

English

[Product Environmental Compliance](#)

[MD_770065-1_060820181143_dmtec](#)

English

[MD_770065-1_060820181143_dmtec](#)

English

[Agency Approvals](#)

[UL Report](#)

English