



PIDG

TE Internal #: 9-160463-2

Quick Disconnects, Tab & Receptacle, 16 – 14 AWG Wire Size, 1 – 2.5 mm² Wire Size, 2050 – 5180 CMA Wire Size, Mating Tab Width .25 in [6.35 mm], PIDG

[View on TE.com >](#)

Terminals & Splices > Quick Disconnects > PIDG PIGGY BACK FASTON TERMINAL

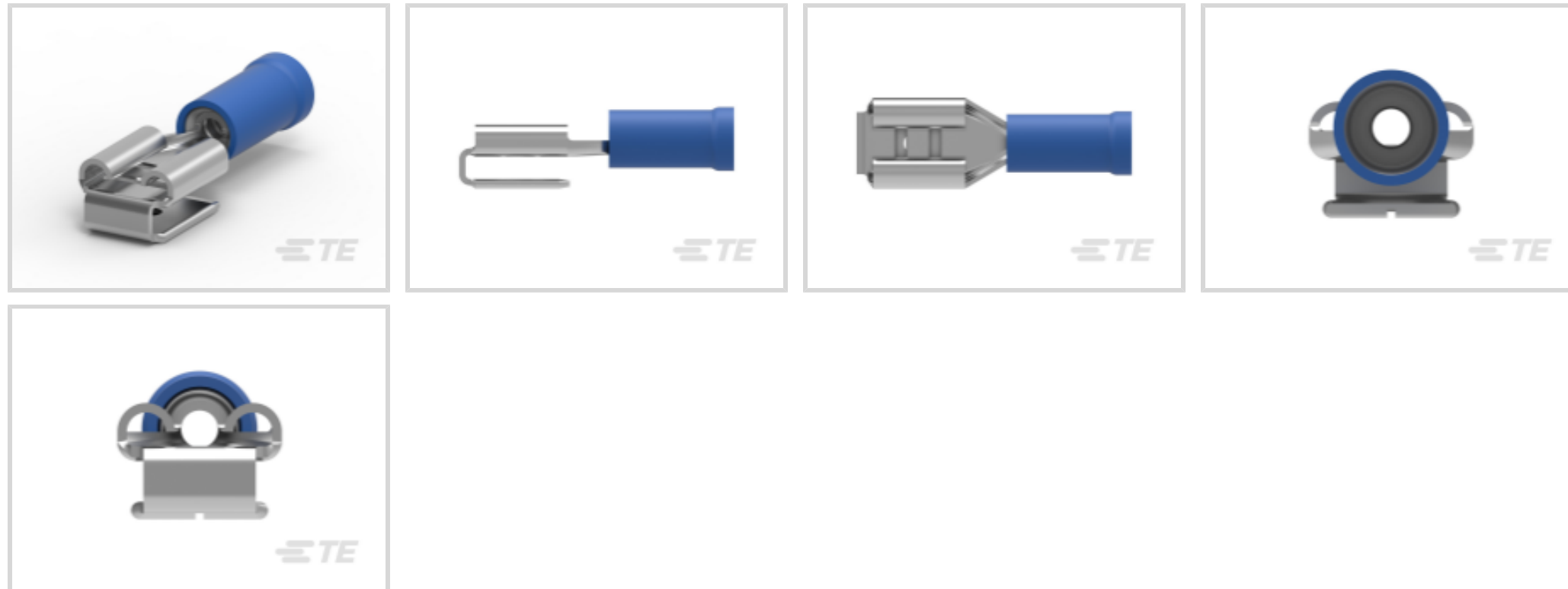

Quick Disconnect Terminal Type: **Tab & Receptacle**

Wire Size: **2050 – 5180 CMA**

Mating Tab Width: **6.35 mm [.25 in]**

All PIDG PIGGY BACK FASTON TERMINAL (2)

Features

Product Type Features

Terminates To	Wire & Cable
Wire Stop	No
Insertion Force	Normal
Sealable	No

Configuration Features

Connection Capacity	Single
---------------------	--------

Electrical Characteristics

Voltage (Max)	300 V
---------------	-------

Body Features

Insulation Material	Nylon
---------------------	-------

Contact Features

Quick Disconnect Terminal Type	Tab & Receptacle
Mating Tab Width	6.35 mm [.25 in]



Mating Tab Thickness	.81 mm[.032 in]
Terminal Orientation	Piggyback
Contact Base Material	Brass
Terminal Plating Material	Tin
Crimp Type	Compression
Barrel Type	Closed

Mechanical Attachment

Wire Insulation Support	With
-------------------------	------

Dimensions

Accepts Wire Insulation Diameter Range	4.32 mm[.17 in]
Overall Length	23.41 mm[.922 in]
Wire Size	2050 – 5180 CMA

Usage Conditions

Insulation Option	Partially Insulated
Operating Temperature Range	105 °C[221 °F]

Packaging Features

Packaging Quantity	50
Packaging Method	Box

Other

Barrel Color	Blue
--------------	------

Product Compliance

[For compliance documentation, visit the product page on TE.com>](#)

EU RoHS Directive 2011/65/EU	Compliant
EU ELV Directive 2000/53/EC	Compliant
China RoHS 2 Directive MIIT Order No 32, 2016	No Restricted Materials Above Threshold
EU REACH Regulation (EC) No. 1907/2006	Current ECHA Candidate List: JUNE 2022 (224) Candidate List Declared Against: JUNE 2022 (224) Does not contain REACH SVHC
Halogen Content	Low Halogen - Br, Cl, F, I < 900 ppm per homogenous material. Also BFR/CFR/PVC Free



Solder Process Capability

Not applicable for solder process capability

Product Compliance Disclaimer

This information is provided based on reasonable inquiry of our suppliers and represents our current actual knowledge based on the information they provided. This information is subject to change. The part numbers that TE has identified as EU RoHS compliant have a maximum concentration of 0.1% by weight in homogenous materials for lead, hexavalent chromium, mercury, PBB, PBDE, DBP, BBP, DEHP, DIBP, and 0.01% for cadmium, or qualify for an exemption to these limits as defined in the Annexes of Directive 2011/65/EU (RoHS2). Finished electrical and electronic equipment products will be CE marked as required by Directive 2011/65/EU. Components may not be CE marked. Additionally, the part numbers that TE has identified as EU ELV compliant have a maximum concentration of 0.1% by weight in homogenous materials for lead, hexavalent chromium, and mercury, and 0.01% for cadmium, or qualify for an exemption to these limits as defined in the Annexes of Directive 2000/53/EC (ELV). Regarding the REACH Regulation, the information TE provides on SVHC in articles for this part number is based on the latest European Chemicals Agency (ECHA) 'Guidance on requirements for substances in articles' posted at this URL: <https://echa.europa.eu/guidance-documents/guidance-on-reach>

Compatible Parts

TE Part # 58433-3
PRO CR ASSY, RBY IS9252

TE Part # 58423-1
DIE, RBY IS9252

TE Part # 47387-7
DAHT PG PIDG 16-12 ASSY

TE Part # 2-1377175-1
SMP 9-0160463-2

TE Part # 169400
CERTI-LOK

TE Part # 169404
CERTI-LOK DIE

Also in the Series | PIDG

Compression Connectors(17)

Crimp Terminal Housings(1)

Crimp Wire Pins, Tabs & Ferrules(41)

Knife Disconnects(11)



PCB Terminals(9)



Portable Crimp Tools(2)

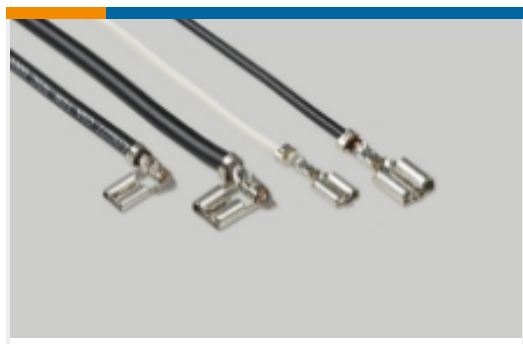

Quick Disconnects(53)



Ring Terminals & Spade Terminals(861)



Special Purpose Terminals(1)



Splices(48)

Customers Also Bought

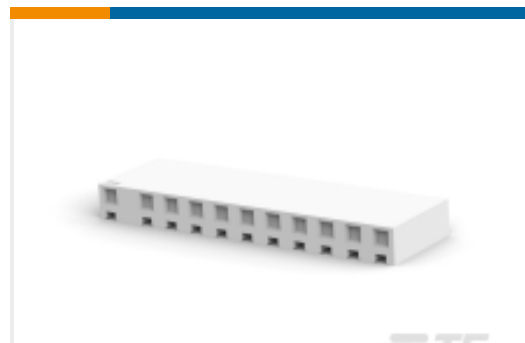

TE Part #1-1744074-1
11P SL LID HSG W/O RAMP SPECIAL CL

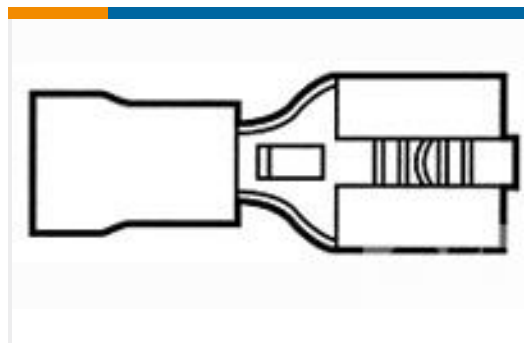

TE Part #42844-3
RECEPT,PIDG FASTON 14-12 250



TE Part #350199-1
RING TONGUE TERMINAL 18-14 AWG NIPST



TE Part #521208-1
POSI-LOK HSG.250-6 POS RAST5

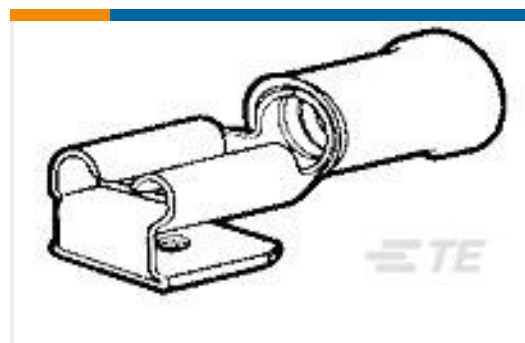

TE Part #160834-2
PIDG PIGGY-B FASTON



TE Part #980892-000
1330-3300-10



TE Part #276959-2
SPLICE,TERMI-FOIL TAP



TE Part #42579-1
250 FASTON REC 16-12 AWG NPST

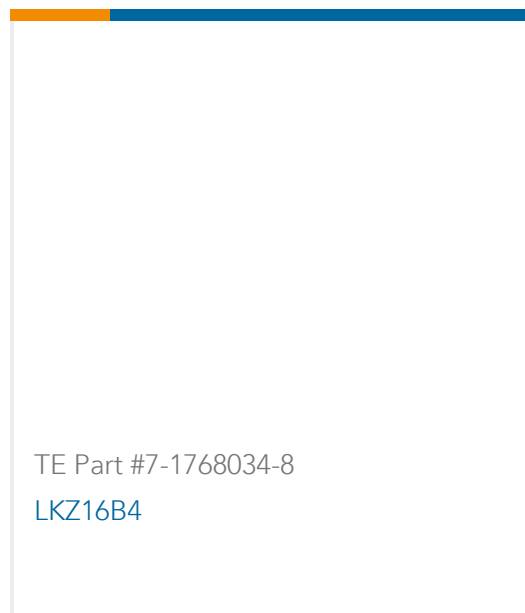

TE Part #7-1768034-8
LKZ16B4

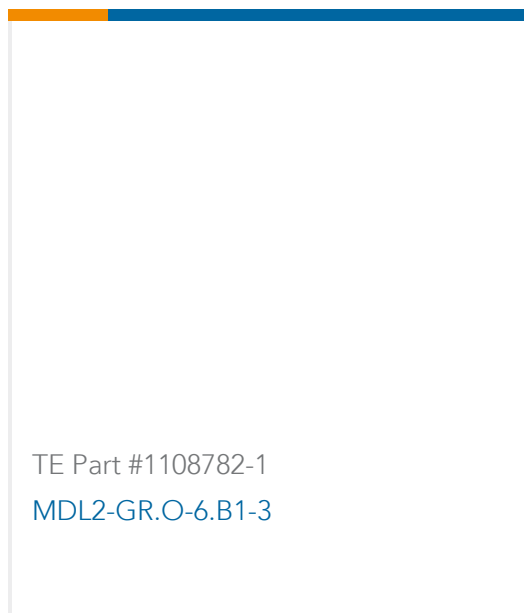

TE Part #1108782-1
MDL2-GR.O-6.B1-3

Documents



Product Drawings

[FASTON, PGYBCK, PIDG, BRASS, .250, 16-14](#)

English

CAD Files

[3D PDF](#)

English

Customer View Model

[ENG_CVM_9-160463-2_F2.2d_dxf.zip](#)

English

Customer View Model

[ENG_CVM_9-160463-2_F2.3d_igs.zip](#)

English

Customer View Model

[ENG_CVM_9-160463-2_F2.3d_stp.zip](#)

English

[3D PDF](#)

3D

Customer View Model

[ENG_CVM_CVM_9-160463-2_S.2d_dxf.zip](#)

English

Customer View Model

[ENG_CVM_CVM_9-160463-2_S.3d_igs.zip](#)

English

Customer View Model

[ENG_CVM_CVM_9-160463-2_S.3d_stp.zip](#)

English

By downloading the CAD file I accept and agree to the [Terms and Conditions](#) of use.

Datasheets & Catalog Pages

[PIDG TERMINALS & SPLICES Quick Reference Guide](#)

English

Product Environmental Compliance

[MD_9-160463-2_070720142324_dmtec](#)

English

[MD_9-160463-2_070720142324_dmtec](#)

English