

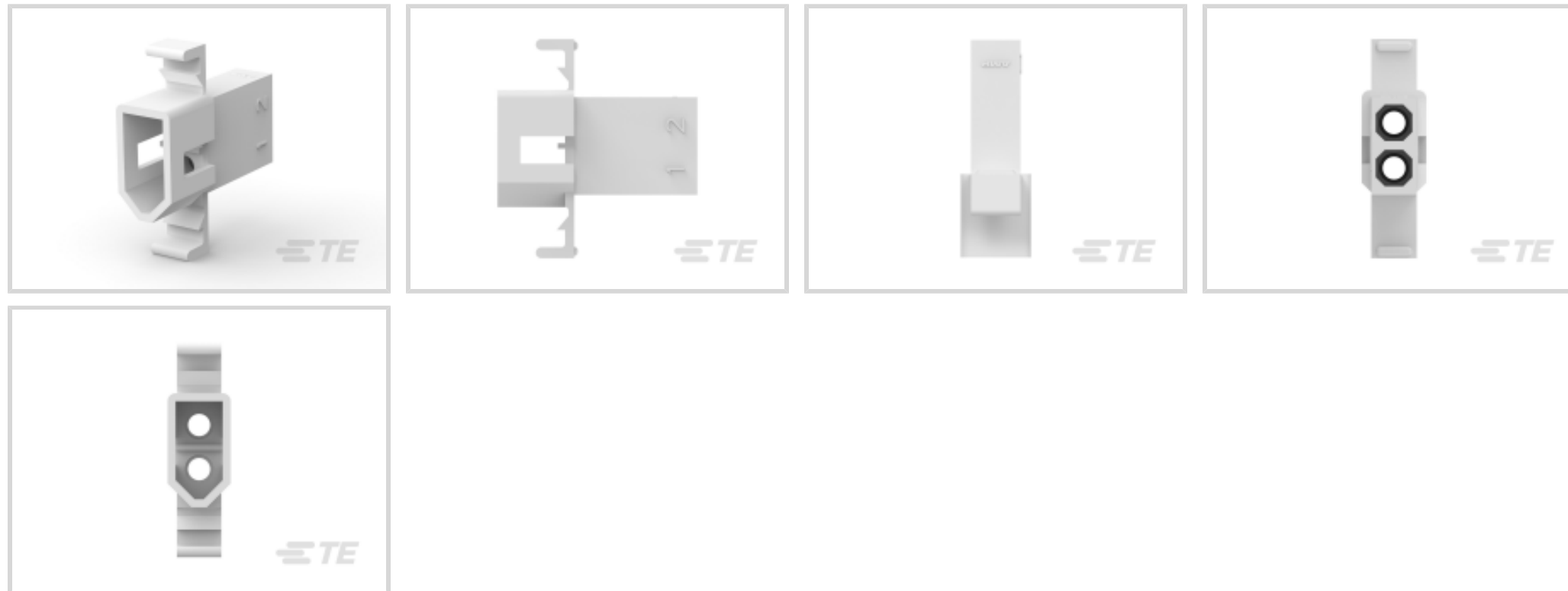

Connectors > Power Connectors > Rectangular Power > Rectangular Power Connectors



Rectangular Power Connector Type: **Housing**

Connector & Housing Type: **Plug**

Connector System: **Wire-to-Panel, Wire-to-Wire**

Number of Positions: **2**

Centerline (Pitch): **6.3 mm [.248 in]**

Features

Product Type Features

Rectangular Power Connector Type	Housing
Connector & Housing Type	Plug
Connector System	Wire-to-Panel, Wire-to-Wire
Sealable	No
Connector & Contact Terminates To	Wire & Cable

Configuration Features

Number of Positions	2
Number of Signal Positions	2
Number of Rows	1

Electrical Characteristics

Operating Voltage	600 VAC
-------------------	---------

Contact Features

Contact Layout	Inline
Contact Retention Within Housing	Without



Contact Type	Pin
--------------	-----

Termination Features

Termination Method to Wire & Cable	Crimp
------------------------------------	-------

Mechanical Attachment

Panel Mount Feature	With
---------------------	------

Panel Mount Feature Type	Mounting Ears
--------------------------	---------------

Connector Mounting Type	Panel Mount
-------------------------	-------------

Housing Features

Centerline (Pitch)	6.3 mm[.248 in]
--------------------	-----------------

Housing Color	Natural
---------------	---------

Housing Material	Nylon 6/6
------------------	-----------

Dimensions

Width	9.02 mm
-------	---------

Panel Thickness	2.29 mm[.09 in]
-----------------	-----------------

Height	30.48 mm
--------	----------

Length	27.81 mm
--------	----------

Usage Conditions

Operating Temperature Range	-55 – 105 °C[-67 – 221 °F]
-----------------------------	----------------------------

Operation/Application

Circuit Application	Power & Signal
---------------------	----------------

Industry Standards

CSA Rating	Certified
------------	-----------

UL Flammability Rating	UL 94V-2
------------------------	----------

Glow Wire Rating	Standard Part - Not Glow Wire
------------------	-------------------------------

Agency/Standard Number	E28476
------------------------	--------

Agency/Standard	CSA, UL
-----------------	---------

UL Rating	Recognized
-----------	------------

CSA File Number	LR7189
-----------------	--------

VDE Tested	Yes
------------	-----

Packaging Features

Packaging Method	Package
------------------	---------

Packaging Quantity	1
--------------------	---



Other

For Use With	Receptacle Housing
--------------	--------------------

Product Compliance

[For compliance documentation, visit the product page on TE.com>](#)

EU RoHS Directive 2011/65/EU	Compliant
EU ELV Directive 2000/53/EC	Compliant
China RoHS 2 Directive MIIT Order No 32, 2016	No Restricted Materials Above Threshold
EU REACH Regulation (EC) No. 1907/2006	Current ECHA Candidate List: JUNE 2022 (224) Candidate List Declared Against: JAN 2022 (223) SVHC > Threshold: Not Yet Reviewed
Halogen Content	BFR/CFR/PVC Free, but Br/Cl >900 ppm in other sources.
Solder Process Capability	Not applicable for solder process capability

Product Compliance Disclaimer

This information is provided based on reasonable inquiry of our suppliers and represents our current actual knowledge based on the information they provided. This information is subject to change. The part numbers that TE has identified as EU RoHS compliant have a maximum concentration of 0.1% by weight in homogenous materials for lead, hexavalent chromium, mercury, PBB, PBDE, DBP, BBP, DEHP, DIBP, and 0.01% for cadmium, or qualify for an exemption to these limits as defined in the Annexes of Directive 2011/65/EU (RoHS2). Finished electrical and electronic equipment products will be CE marked as required by Directive 2011/65/EU. Components may not be CE marked. Additionally, the part numbers that TE has identified as EU ELV compliant have a maximum concentration of 0.1% by weight in homogenous materials for lead, hexavalent chromium, and mercury, and 0.01% for cadmium, or qualify for an exemption to these limits as defined in the Annexes of Directive 2000/53/EC (ELV). Regarding the REACH Regulation, the information TE provides on SVHC in articles for this part number is based on the latest European Chemicals Agency (ECHA) 'Guidance on requirements for substances in articles' posted at this URL: <https://echa.europa.eu/guidance-documents/guidance-on-reach>

Compatible Parts



TE Part # 770147-1
.093 CP&S PIN PTPBR LP 24-18



TE Part # 770065-1
02P .093 COMM P&S RECPT .248CL



TE Part # 770424-1
02P.093 COMM P&S RCPT .248CL



TE Part # 770425-1
02P .093 COMM P&S PLUG .248CL



TE Part # 770069-1
.02P .093 COMM P&S PLUG .248CL



TE Part # 350416-1
.093 COMM P&S PIN 14-20 PTPBR



TE Part # 770066-1
02P .093 COMM P&S RECPT .248CL



TE Part # 770529-1
.093 COMM P&S SOK 14-20 PTPBR



TE Part # 770530-1
.093 COMM P&S PIN 14-20 PTPBR



TE Part # 350415-1
.093 COMM P&S SOK 14-20 PTPBR



TE Part # 350418-1
.093 COMM P&S PIN 18-24 PTPBR



TE Part # 350417-1
.093 COMM P&S SOK 18-24 PTPBR



TE Part # 350415-5
.093 COMM P&S SOK 20-14 AUBR



TE Part # 770145-1
.093 COMM P&S PIN PTPBR LP



TE Part # 770146-1
.093 CP&S SOK PTPBR LP 24-18



TE Part # 770266-1
02P .093 COMM P&S RECPT .248CL



TE Part # 350416-5
.093 COMM P&S PIN AU/NI/BR



TE Part # 770144-1
.093 CP&S SOK PTPBR L/P 20-14



TE Part # 770144-5
.093 CP&S SOC AUBR L/P 20-14



TE Part # 350415-6
.093 COMM P&S SOK 14-20 PTPHBZ

Also in the Series | Commercial Pin and Socket Connectors

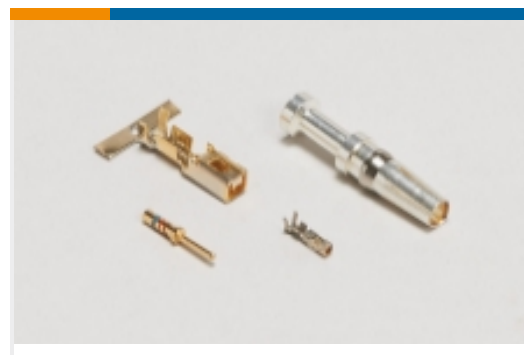

Connector Contacts(3)



Crimp Wire Pins, Tabs & Ferrules(1)



Insertion & Extraction Tools(3)

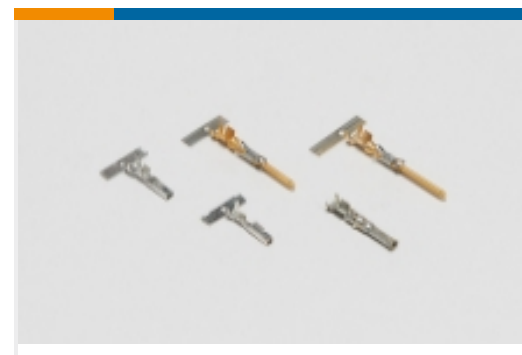

Power Contacts(40)



Rectangular Connector Housings(11)



Rectangular Power Connectors(88)

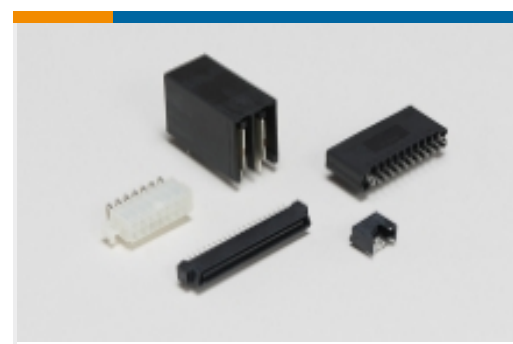

Standard Rectangular Connectors(4)

Customers Also Bought

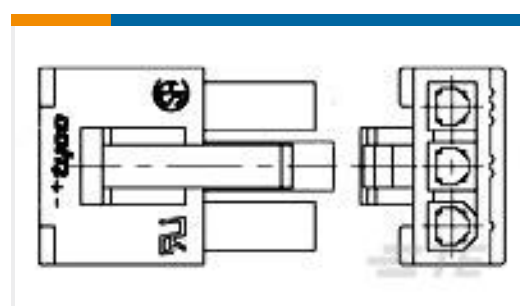
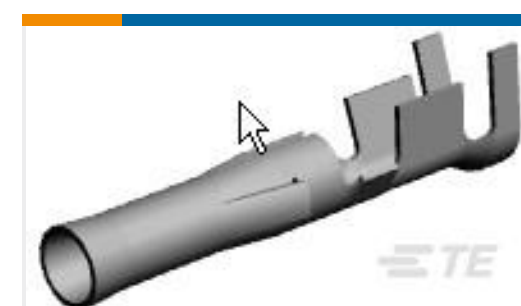
TE Part #1-770849-2
12P SL156 HSG W/LCK RMP & TABSTE Part #521411-2
ULTRA POD: Flag, Receptacle
Assembly, Tin Plated, .250 inchTE Part #36922
TERMINAL,SOLIS R 2/0 5/16TE Part #770529-1
.093 COMM P&S SOK 14-20 PTPBRTE Part #61794-4
RING 18-14 AWG BRTE Part #2029178-5
5P SR RCPT VAL-U-LOK GWTE Part #DT04-2P-RT25
REC, 2P, BLK, 27K OHM RESISTOR, NITE Part #770144-1
.093 CP&S SOK PTPBR L/P 20-14TE Part #1-66740-9
TYPE XII FEMALE CONT (STRIP)

Documents

Product Drawings

[02P .093 COMM P&S PLUG .248CL](#)

English

CAD Files

[3D PDF](#)

English

Customer View Model

[ENG_CVM_770068-1_M.2d_dxf.zip](#)



English

Customer View Model

[ENG_CVM_770068-1_M.3d_igs.zip](#)

English

Customer View Model

[ENG_CVM_770068-1_M.3d_stp.zip](#)

English

3D PDF

3D

Customer View Model

[ENG_CVM_CVM_770068-1_T.2d_dxf.zip](#)

English

Customer View Model

[ENG_CVM_CVM_770068-1_T.3d_igs.zip](#)

English

Customer View Model

[ENG_CVM_CVM_770068-1_T.3d_stp.zip](#)

English

By downloading the CAD file I accept and agree to the [Terms and Conditions](#) of use.

Datasheets & Catalog Pages

[SOFT_SHELL_PIN_SOCKET_CONNECTORS_STANDARD_DENSITY](#)

English

Product Specifications

[Application Specification](#)

English

Agency Approvals

[UL Report](#)

English