



Connectors > Power Connectors > Power Contacts

Power Contact Type: **Contact**Operating Voltage: **600 VAC**Contact Mating Area Plating Material: **Pre-Tin**Wire Size: **.2 – 1 mm²**

Features

Product Type Features

Power Contact Type	Contact
Connector System	Wire-to-Wire
Connector & Contact Terminates To	Wire & Cable

Electrical Characteristics

Operating Voltage	600 VAC
-------------------	---------

Contact Features

Contact Mating Area Plating Material	Pre-Tin
Contact Current Rating (Max)	7 A
Contact Type	Socket
Contact Retention Within Housing	Without
Mating Pin Diameter	2.18 mm [.086 in]
Contact Base Material	Phosphor Bronze
Wire Contact Termination Area Plating Material	Pre-Tin
Wire Contact Termination Area Plating Material Finish	Matte
Contact Orientation	Straight



Termination Features

Termination Method to Wire & Cable	Crimp
------------------------------------	-------

Mechanical Attachment

Connector Mounting Type	Cable Mount (Free-Hanging)
Wire Insulation Support	Without

Dimensions

Wire Size	.2 – 1 mm ²
Accepts Wire Insulation Diameter Range	1.02 – 2.54 mm [.04 – .1 in]

Usage Conditions

Operating Temperature Range	-55 – 120 °C [-67 – 248 °F]
-----------------------------	-----------------------------

Operation/Application

Circuit Application	Power
---------------------	-------

Industry Standards

CSA Rating	Certified
Glow Wire Rating	Standard Part - Not Glow Wire
VDE Tested	Yes
Agency/Standard	CSA, UL
CSA File Number	LR 7189
UL Rating	Recognized
UL File Number	E28476

Packaging Features

Packaging Method	Bag
Packaging Quantity	1000

Other

Wire/Cable Type	Discrete Wire
Wire Type	Stranded
For Use With	Standard Universal MATE-N-LOK(Pin)

Product Compliance

[For compliance documentation, visit the product page on TE.com>](#)

EU RoHS Directive 2011/65/EU	Compliant
------------------------------	-----------



EU ELV Directive 2000/53/EC	Compliant
China RoHS 2 Directive MIIT Order No 32, 2016	No Restricted Materials Above Threshold
EU REACH Regulation (EC) No. 1907/2006	Current ECHA Candidate List: JUNE 2022 (224) Candidate List Declared Against: JAN 2022 (223) SVHC > Threshold: Not Yet Reviewed
Halogen Content	Low Halogen - Br, Cl, F, I < 900 ppm per homogenous material. Also BFR/CFR/PVC Free
Solder Process Capability	Not applicable for solder process capability

Product Compliance Disclaimer

This information is provided based on reasonable inquiry of our suppliers and represents our current actual knowledge based on the information they provided. This information is subject to change. The part numbers that TE has identified as EU RoHS compliant have a maximum concentration of 0.1% by weight in homogenous materials for lead, hexavalent chromium, mercury, PBB, PBDE, DBP, BBP, DEHP, DIBP, and 0.01% for cadmium, or qualify for an exemption to these limits as defined in the Annexes of Directive 2011/65/EU (RoHS2). Finished electrical and electronic equipment products will be CE marked as required by Directive 2011/65/EU. Components may not be CE marked. Additionally, the part numbers that TE has identified as EU ELV compliant have a maximum concentration of 0.1% by weight in homogenous materials for lead, hexavalent chromium, and mercury, and 0.01% for cadmium, or qualify for an exemption to these limits as defined in the Annexes of Directive 2000/53/EC (ELV). Regarding the REACH Regulation, the information TE provides on SVHC in articles for this part number is based on the latest European Chemicals Agency (ECHA) 'Guidance on requirements for substances in articles' posted at this URL: <https://echa.europa.eu/guidance-documents/guidance-on-reach>

Compatible Parts

TE Part # 91510-1
CCII UNML UNML II PIN SKT 24-18 ASSY

TE Part # 90548-2
PROCRIMPER DIE ASSY UNIV MNL

TE Part # 770022-1
12P UMNLII IN-LINE PLUG HSG KIT

TE Part # 770019-1
04P UMNLII IN-LINE PLUG HSG KIT

TE Part # 770028-1
09P UMNLII IN-LINE CAP HSG KIT

TE Part # 770026-1
04P UMNLII IN-LINE CAP HSG KIT

TE Part # 770024-1
02P UMNLII IN-LINE CAP HSG KIT

TE Part # 770021-1
09P UMNLII IN-LINE PLUG HSG KIT



TE Part # 770030-1
15P UMNLI IN-LINE CAP HSG KIT



TE Part # 770018-1
03P UMNLI IN-LNE PLUG HSG KIT



TE Part # 770027-1
06P UMNLI IN-LINE CAP HSG KIT



TE Part # 770025-1
03P UMNLI IN-LINE CAP HSG KIT



TE Part # 770017-1
02P UMNLI IN-LNE PLUG HSG KIT



TE Part # 770020-1
06P UMNLI IN-LNE PLUG HSG KIT



TE Part # 770023-1
15P UMNLI IN-LNE PLUG HSG KIT



TE Part # 90548-1
ASSY PRO-CRIMPER UNIV M-N-L



TE Part # 770016-1
05P UMNLI IN-LNE PLUG HSG KIT



TE Part # 770029-1
12P UMNLI IN-LINE CAP HSG KIT



TE Part # 2378734-1
SDE F UNIV MATE-N-LOK 18-24 AWG ASSY



TE Part # 2378734-2
SDE F UNIV MATE-N-LOK 18-24 AWG DIE SET

Also in the Series | **Universal MATE-N-LOK**



Circular Power Connectors(2)

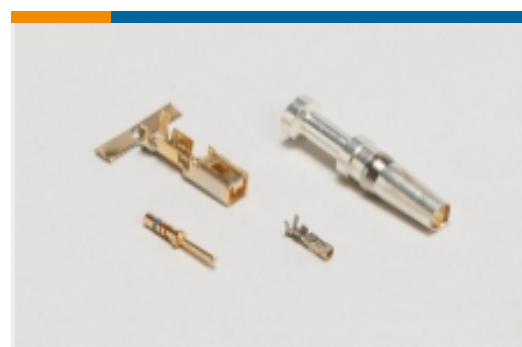

Connector Contacts(11)



Insertion & Extraction Tools(4)

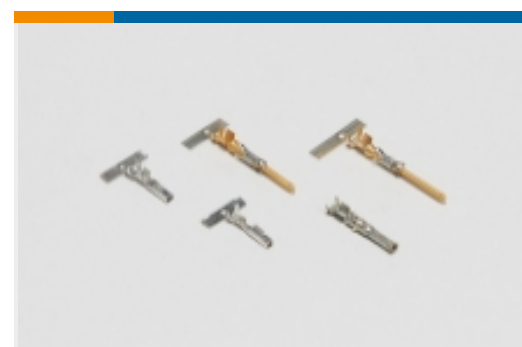

Power Contacts(207)



Rectangular Boots & Strain Relief(35)



Rectangular Connector Adapters(7)



Rectangular Connector Hardware(1)



Rectangular Connector Housings(2)



Rectangular Connector Keying Plugs(3)



Rectangular Connector Locking(4)

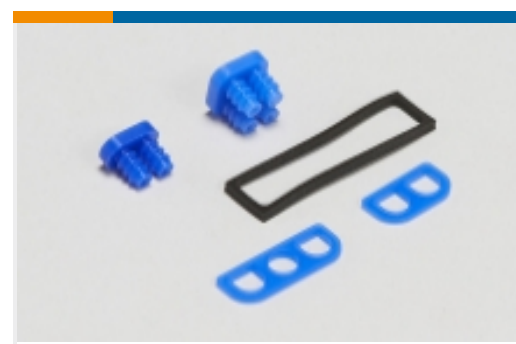

Rectangular Connector Seals(26)



Rectangular Power Connectors(729)

Customers Also Bought

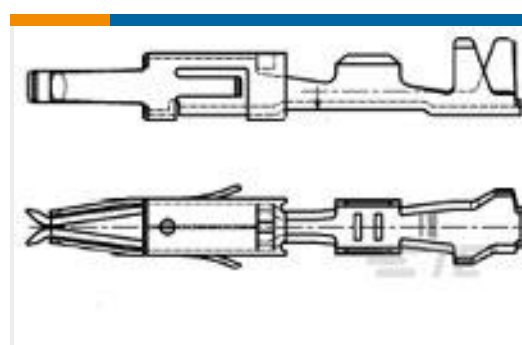
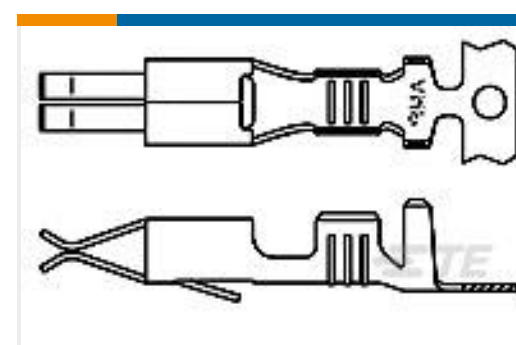
TE Part #770030-1
15P UMNLII IN-LINE CAP HSG KITTE Part #1-770253-0
UMNLII SOK PTPPHBZ LP LF 24-18TE Part #DTM13-12PB-R008
DEUTSCH DTM HEADERSTE Part #HD10-9-1939P-BP03
RECP ASMTE Part #962942-1
MT2 REC 1.6 Contact SRC SnTE Part #1-770252-0
UMNL II PIN LP 14-18TE Part #1757828-3
AMPLIMITE,RCPT ASY,POSTD,109,ZN,
3TE Part #643222-1
MINI-SPRING RECEPTACLE 20-16
AWG PTPBR

Documents

Product Drawings

[UMNL II SOK PTPPHBZ LP 24-18](#)

English

CAD Files

[3D PDF](#)

English

Customer View Model

[ENG_CVM_770253-3_C.2d_dxf.zip](#)

English

Customer View Model

[ENG_CVM_770253-3_C.3d_igs.zip](#)

English

Customer View Model

[ENG_CVM_770253-3_C.3d_stp.zip](#)

English

[3D PDF](#)



3D

Customer View Model

[ENG_CVM_CVM_770253-3_B.2d_dxf.zip](#)

English

Customer View Model

[ENG_CVM_CVM_770253-3_B.3d_igs.zip](#)

English

Customer View Model

[ENG_CVM_CVM_770253-3_B.3d_stp.zip](#)

English

By downloading the CAD file I accept and agree to the [Terms and Conditions](#) of use.

Datasheets & Catalog Pages

[SOFT_SHELL_PIN_SOCKET_CONNECTORS_STANDARD_DENSITY](#)

English

Product Specifications

[Application Specification](#)

English

Product Environmental Compliance

[TE Material Declaration](#)

English