



# TS SEALED SERIES

## Features

The TS sealed connector series has a mechanism of terminal position assurance.

This series consists of 025, 040, 090, 187, and 312 types classified according to terminal size, covering an extensive array of applications from signal to power circuits.

- Retainers are pre-mounted on the connector housing, and are structured to enable setting by the same simple operation regardless of the number of ways, improving operability.
- These connectors can be directly secured to a bracket on the car body.

### Structure

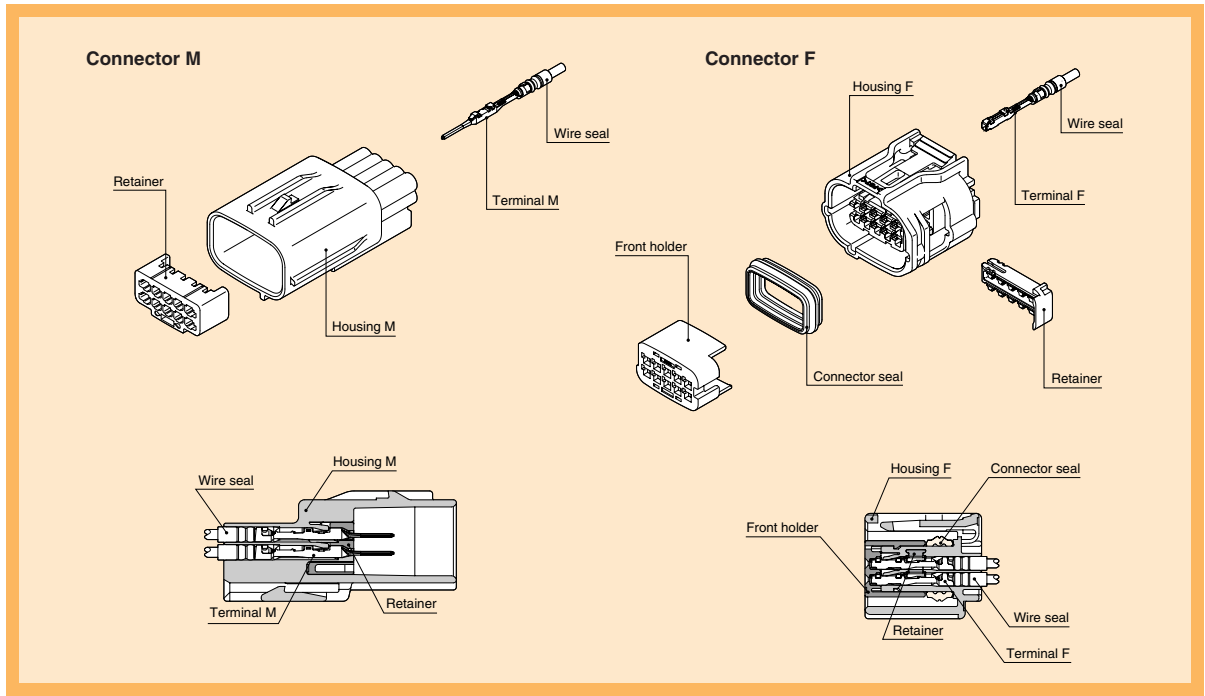

### Terminal (UNIT: mm)

Cable size (mm <sup>2</sup> )	0.22~0.5
Material	Brass
Surface treatment	Tin-plated
Reel (piece)	7000
Thickness (mm)	0.25

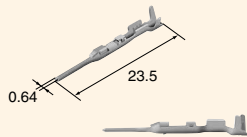

**M(8100-3617)**

Cable size (mm <sup>2</sup> )	0.22~0.5
Material	Heat-resistant copper alloy
Surface treatment	Tin-plated
Reel (piece)	7000
Thickness (mm)	0.25

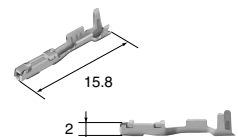

**F(8100-3455)**

Cable size (mm <sup>2</sup> )	0.22~0.5
Material	Brass
Surface treatment	Gold-plated
Reel (piece)	7000
Thickness (mm)	0.25

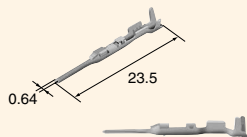

**M(8100-3708)**

Cable size (mm <sup>2</sup> )	0.22~0.5
Material	Heat-resistant copper alloy
Surface treatment	Gold-plated
Reel (piece)	7000
Thickness (mm)	0.25

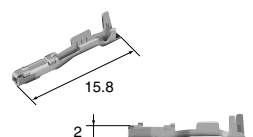

**F(8100-3456)**

025

## Wire seals (UNIT: mm)

- The wire seals are common to M and F.
- ※ A wireseal depends on a chosen cable.

Cable size (mm <sup>2</sup> )	(CHFUS/0.22)
Cable overall diameter (mm)	0.95~1.05
Material	Silicon
Color	Green

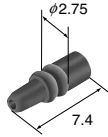

SS Type (7165-1043)

Cable size (mm <sup>2</sup> )	(CHFUS/0.35~0.5)
Cable overall diameter (mm)	1.1~1.4
Material	Silicon
Color	Dark Green

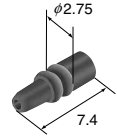

S Type (7165-0851)

Cable size (mm <sup>2</sup> )	(AVSS/0.3) (AVSSH/0.3) (AVSSX/0.3)
Cable overall diameter (mm)	1.4~1.5
Material	Silicon
Color	Reddish Brown

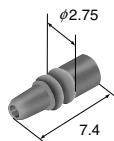

M Type (For AV) (7165-0796)

Cable size (mm <sup>2</sup> )	(AESSX/0.3)
Cable overall diameter (mm)	1.4~1.5
Material	Silicon
Color	Dark Brown

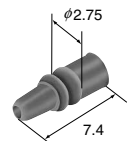

M Type (For AE) (7165-0891)

Cable size (mm <sup>2</sup> )	(AVSS/0.5) (AVSSH/0.5) (AVSSX/0.5)
Cable overall diameter (mm)	1.6~1.7
Material	Silicon
Color	Dark Gray

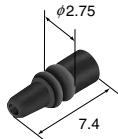

L Type (7165-0815)

Cable size (mm <sup>2</sup> )	(CHFUS/0.35~0.5)
Cable overall diameter (mm)	1.1~1.4
Material	Silicon
Color	Violet

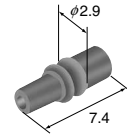

United Wire Seal Size S. (7165-1312)

Cable size (mm <sup>2</sup> )	(AVSS/0.3) (AVSSH/0.3) (AVSSX/0.3)
Cable overall diameter (mm)	1.4~1.5
Material	Silicon
Color	Dark Yellow

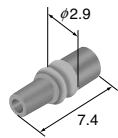

United Wire Seal Size M. (7165-1198)

Cable size (mm <sup>2</sup> )	(AVSS/0.5) (AVSSH/0.5) (AVSSX/0.5) (AESSX/0.5)
Cable overall diameter (mm)	1.6~1.7
Material	Silicon
Color	Red Violet

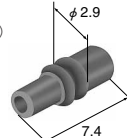

United Wire Seal Size L. (7165-1199)

025

## Dummy plugs (UNIT: mm)

- Dummy plugs are common to M and F.
- Dummy plugs are used to blind unused terminal holes.

Material	N.B.R
Color	Light Gray



(7165-0797)

025

# TS SEALED SERIES

025(0.64 mm)/STANDARD

B-04

## Housing (UNIT: mm)

Material/P.B.T.

2way

Ref: Terminal part No.	B-02
Ref: Wire seal No.	B-03
Ref: Dummy plug No.	B-03
Color	Black

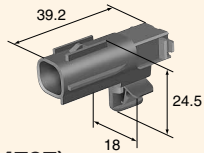

M(6188-4797)

Ref: Terminal part No.	B-02
Ref: Wire seal No.	B-03
Ref: Dummy plug No.	B-03
Color	Black

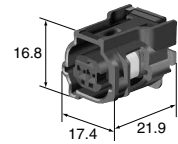

F(6189-1161)

3way

Ref: Terminal part No.	B-02
Ref: Wire seal No.	B-03
Ref: Dummy plug No.	B-03
Color	Black

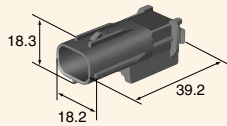

M(6188-4920)

Ref: Terminal part No.	B-02
Ref: Wire seal No.	B-03
Ref: Dummy plug No.	B-03
Color	Gray

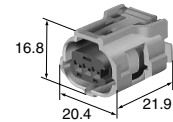

F(6189-1130)

Ref: Terminal part No.	B-02
Ref: Wire seal No.	B-03
Ref: Dummy plug No.	B-03
Color	Gray

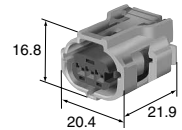

F(6189-1132)

4way

Ref: Terminal part No.	B-02
Ref: Wire seal No.	B-03
Ref: Dummy plug No.	B-03
Color	Gray

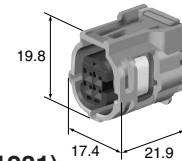

F(6189-1231)

5way

Ref: Terminal part No.	B-02
Ref: Wire seal No.	B-03
Ref: Dummy plug No.	B-03
Color	Black

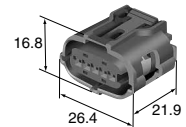

F(6189-1046)

6way

Ref: Terminal part No.	B-02
Ref: Wire seal No.	B-03
Ref: Dummy plug No.	B-03
Color	Natural

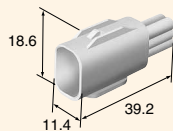

M(6188-0706)

Ref: Terminal part No.	B-02
Ref: Wire seal No.	B-03
Ref: Dummy plug No.	B-03
Color	Natural

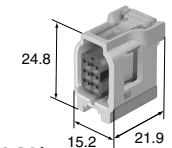

F(6189-1142)

6way

Ref: Terminal part No.	B-02
Ref: Wire seal No.	B-03
Ref: Dummy plug No.	B-03
Color	Black

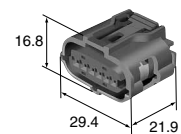

F(6189-1083)

# TS SEALED SERIES

025(0.64 mm) / STANDARD

B-05

8way

Ref: Terminal part No.	B-02
Ref: Wire seal No.	B-03
Ref: Dummy plug No.	B-03
Color	Gray

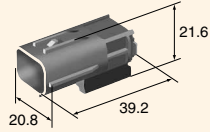

**M(6188-0779)**

Ref: Terminal part No.	B-02
Ref: Wire seal No.	B-03
Ref: Dummy plug No.	B-03
Color	Gray

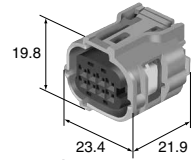

**F(6189-1240)**

10way

Ref: Terminal part No.	B-02
Ref: Wire seal No.	B-03
Ref: Dummy plug No.	B-03
Color	Black

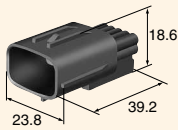

**M(6188-0696)**

Ref: Terminal part No.	B-02
Ref: Wire seal No.	B-03
Ref: Dummy plug No.	B-03
Color	Black

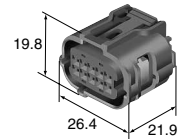

**F(6189-1134)**

12way

Ref: Terminal part No.	B-02
Ref: Wire seal No.	B-03
Ref: Dummy plug No.	B-03
Color	Black

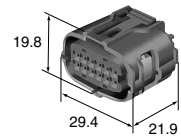

**F(6189-1128)**

Ref: Terminal part No.	B-02
Ref: Wire seal No.	B-03
Ref: Dummy plug No.	B-03
Color	Gray

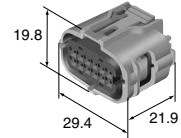

**F(6189-1133)**

13way

Ref: Terminal part No.	B-02
Ref: Wire seal No.	B-03
Ref: Dummy plug No.	B-03
Color	Gray

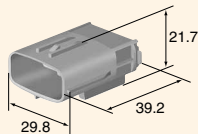

**M(6188-4914)**

Ref: Terminal part No.	B-02
Ref: Wire seal No.	B-03
Ref: Dummy plug No.	B-03
Color	Gray

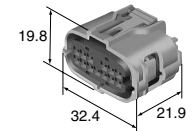

**F(6189-1092)**

15way

Ref: Terminal part No.	B-02
Ref: Wire seal No.	B-03
Ref: Dummy plug No.	B-03
Color	Gray

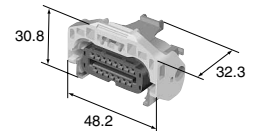

**F(6189-1135)**

30way

Ref: Terminal part No.	B-02
Ref: Wire seal No.	B-03
Ref: Dummy plug No.	B-03
Color	Gray

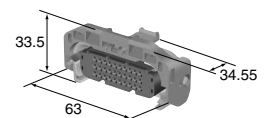

**F(6189-6987)**

# TS SEALED SERIES

025, 090, 187(0.64 mm, 2.3 mm, 4.8 mm) / HYBRID

B-06

## Terminal

●Ref: 025 Terminal List (Page B-02), 090 Terminal List (Page B-09), 187 Terminal List (Page B-17)

## Wire seals

●Ref: 025 Wire seal List (Page B-03), 090 Wire seal List (Page B-10), 187 Wire seal List (Page B-18)

## Dummy plugs

●Ref: 025 Dummy plug List (Page B-03), 090 Dummy plug List (Page B-11), 187 Dummy plug List (Page B-18)

## Housing (UNIT: mm)

Material / P.B.T.

No. of way: ( ) corresponds to 025, 090, 187, in order from left to right.

10way  
(6+4)

Ref: Terminal part No.	[025] B-02 [090] B-09
Ref: Wire seal No.	[025] B-03 [090] B-10 (For P6)
Ref: Dummy plug No.	[025] B-03 [090] B-11 (For P6)
Color	Black

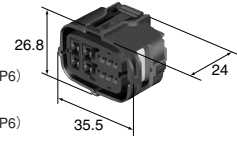

**F(6189-1163)**

26way  
(23+3)

Ref: Terminal part No.	[025] B-02 [090] B-09
Ref: Wire seal No.	[025] B-03 [090] B-10 (For P5)
Ref: Dummy plug No.	[025] B-03 [090] B-11 (For P5)
Color	Black

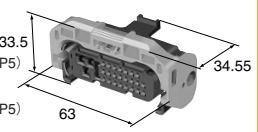

**F(6189-6934)**

40way  
(36+4)

Ref: Terminal part No.	[025] B-02 [187] B-17
Ref: Wire seal No.	[025] B-03 [187] B-18
Ref: Dummy plug No.	[025] B-03 [187] B-18
Color	Gray

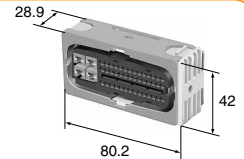

**F(6189-1160)**

46way  
(42+4)

Ref: Terminal part No.	[025] B-02 [187] B-17
Ref: Wire seal No.	[025] B-03 [187] B-18
Ref: Dummy plug No.	[025] B-03 [187] B-18
Color	Black

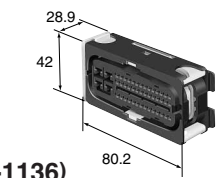

**F(6189-1136)**

46way  
(42+4)

Ref: Terminal part No.	[025] B-02 [187] B-17
Ref: Wire seal No.	[025] B-03 [187] B-18
Ref: Dummy plug No.	[025] B-03 [187] B-18
Color	Black

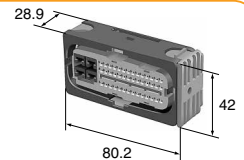

**F(6189-6894)**

## Terminal

※For terminal selection, please contact our sales staff.

## Wire seals (UNIT: mm)

●The wire seals are common to M and F.

040

Cable size (mm <sup>2</sup> )	(AVSS / 0.3~0.5) (AVSSX / 0.3~0.5) (AESSX / 0.3~0.5) (CAVUS / 0.3~0.5)
Cable overall diameter (mm)	1.1~1.7
Material	Silicone
Color	Dark Brown

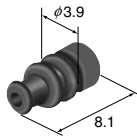

S Type **(7165-0728)**

## Dummy plugs

※For dummy plugs selection, please contact our sales staff.

## Housing (UNIT: mm)

Material / P.B.T.  
Color / Natural

3way

Ref: Terminal part No.	※
Ref: Wire seal No.	B-07
Ref: Dummy plug No.	※

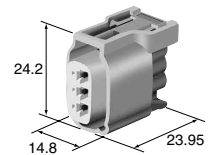

**F(6189-0892)**

## Terminal

※For terminal selection, please contact our sales staff.

## Wire seals

●Ref: 040 Wire seal List (Page B-07), 187 Wire seal List (Page B-18)

## Dummy plugs

※For dummy plugs selection, please contact our sales staff.

## Housing (UNIT: mm)

Material / P.B.T.

Color / Black

No. of way : ( ) corresponds to 040, 187, in order from left to right.

24way  
(20+4)

Ref: Terminal part No.  
[040] ※ [187] B-17  
Ref: Wire seal No.  
[040] B-07 [187] B-18  
Ref: Dummy plug No.  
[040] ※ [187] B-18

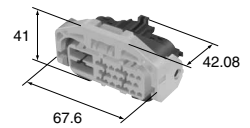

F(6189-0886)

34way  
(30+4)

Ref: Terminal part No.  
[040] ※ [187] B-17  
Ref: Wire seal No.  
[040] B-07 [187] B-18  
Ref: Dummy plug No.  
[040] ※ [187] B-18

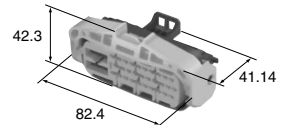

F(6189-0804)



## Structure

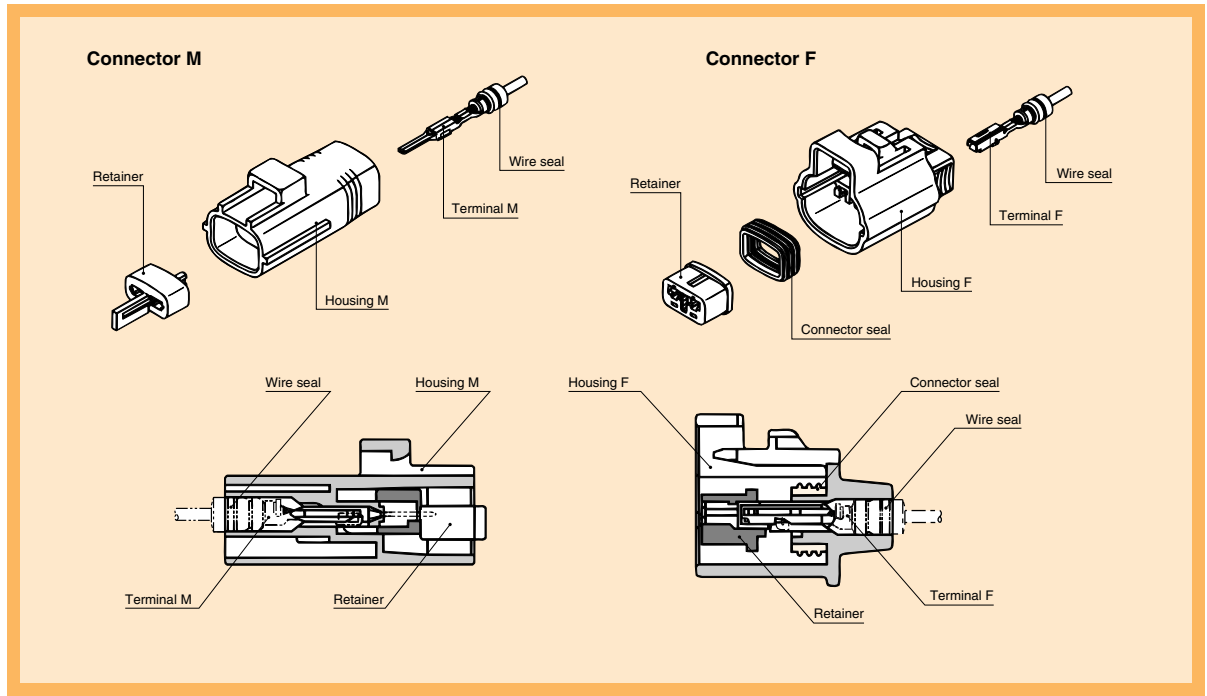

## Terminal (UNIT: mm)

Cable size (mm <sup>2</sup> )	0.3~0.5
Cable overall diameter (mm)	1.4~2.1
Material	Brass
Surface treatment	Tin-plated
Reel (piece)	4000
Thickness (mm)	0.3

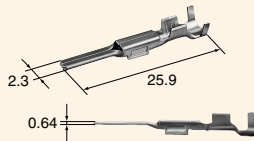

**M(8100-0457)**

Cable size (mm <sup>2</sup> )	0.3~0.5
Cable overall diameter (mm)	1.4~2.1
Material	Heat-resistant copper alloy
Surface treatment	Tin-plated
Reel (piece)	4000
Thickness (mm)	0.25

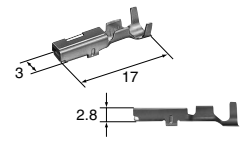

**F(8100-0460)**

Cable size (mm <sup>2</sup> )	0.3~0.5
Cable overall diameter (mm)	1.4~2.2
Material	Brass
Surface treatment	Gold-plated
Reel (piece)	4000
Thickness (mm)	0.3

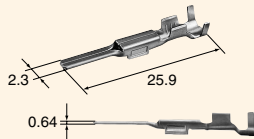

**M(8100-1340)**

Cable size (mm <sup>2</sup> )	0.3~0.5
Cable overall diameter (mm)	1.4~2.2
Material	Heat-resistant copper alloy
Surface treatment	Gold-plated
Reel (piece)	4000
Thickness (mm)	0.25

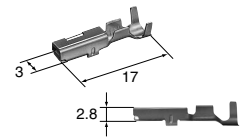

**F(8100-1344)**

Cable size (mm <sup>2</sup> )	0.5~1.25
Cable overall diameter (mm)	1.6~2.6
Material	Brass
Surface treatment	Tin-plated
Reel (piece)	4000
Thickness (mm)	0.3

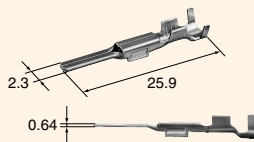

**M(8100-0458)**

Cable size (mm <sup>2</sup> )	0.5~1.25
Cable overall diameter (mm)	1.6~2.6
Material	Heat-resistant copper alloy
Surface treatment	Tin-plated
Reel (piece)	4000
Thickness (mm)	0.25

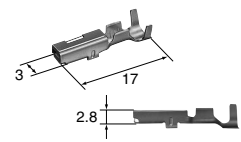

**F(8100-0461)**

090

090

Cable size (mm <sup>2</sup> )	0.5~1.25
Cable overall diameter (mm)	1.6~2.9
Material	Brass
Surface treatment	Gold-plated
Reel (piece)	4000
Thickness (mm)	0.3

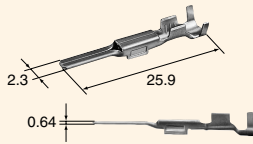

**M(8100-1007)**

Cable size (mm <sup>2</sup> )	0.5~1.25
Cable overall diameter (mm)	1.6~2.9
Material	Heat-resistant copper alloy
Surface treatment	Gold-plated
Reel (piece)	4000
Thickness (mm)	0.25

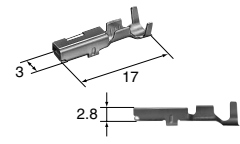

**F(8100-0594)**

Cable size (mm <sup>2</sup> )	2.0
Cable overall diameter (mm)	2.6~2.7
Material	Brass
Surface treatment	Tin-plated
Reel (piece)	3000
Thickness (mm)	0.3

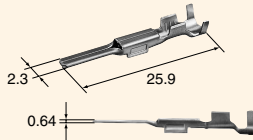

**M(8100-0459)**

Cable size (mm <sup>2</sup> )	2.0
Cable overall diameter (mm)	2.6~2.7
Material	Heat-resistant copper alloy
Surface treatment	Tin-plated
Reel (piece)	3000
Thickness (mm)	0.25

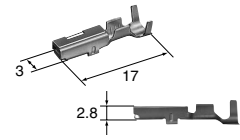

**F(8100-0462)**

Cable size (mm <sup>2</sup> )	2.0
Cable overall diameter (mm)	2.6~2.9
Material	Brass
Surface treatment	Gold-plated
Reel (piece)	4000
Thickness (mm)	0.3

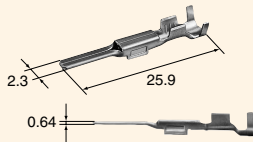

**M(8100-1008)**

Cable size (mm <sup>2</sup> )	2.0
Cable overall diameter (mm)	2.6~2.9
Material	Heat-resistant copper alloy
Surface treatment	Gold-plated
Reel (piece)	3000
Thickness (mm)	0.25

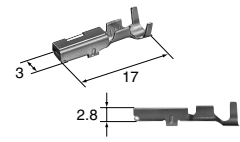

**F(8100-0817)**

### Wire seals (UNIT: mm)

- The wire seals are common to M and F.
- P5 : For 5mm pitch housing/Please inquire us for the details.
- P6 : For 6mm pitch housing

090  
(For P5)

Cable size (mm <sup>2</sup> )	(AVX·AEX/0.3) (AVS/0.3) (AVSS/0.3~0.85) (AVSSX·AESX/0.3~0.75) (CAVUS/0.85~1.25)
Cable overall diameter (mm)	1.4~2.0
Material	Silicone
Color	Brown

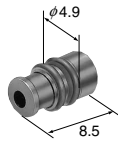

**S Type (7165-0342)**

Cable size (mm <sup>2</sup> )	(AV/0.5~0.85) (AVX·AEX/0.5~0.75) (AVS/0.5~0.85) (AVSS/1.25) (AVSSX·AESX/1.25)
Cable overall diameter (mm)	2.0~2.5
Material	Silicone
Color	Black

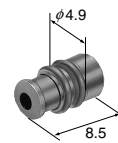

**M Type (7165-0343)**

Cable size (mm <sup>2</sup> )	(AV/1.25) (AVX·AEX/1.25) (AVS/1.25) (AVSS/2.0) (AVSSX·AESX/2.0)
Cable overall diameter (mm)	2.5~2.9
Material	Silicone
Color	Dark Blue

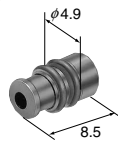

**L Type (7165-0344)**

090  
(For P6)

Cable size (mm <sup>2</sup> )	(CHFUS/0.35~0.5)
Cable overall diameter (mm)	1.1~1.4
Material	Silicone
Color	Blue

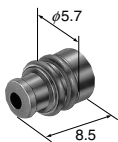

**SS Type (7165-0842)**

Cable size (mm <sup>2</sup> )	(AVX·AEX/0.3) (AVS/0.3) (AVSS/0.3~0.85) (AVSSX·AESX/0.3~0.75) (CAVUS/0.85~1.25)
Cable overall diameter (mm)	1.4~2.0
Material	Silicone
Color	Dark Brown

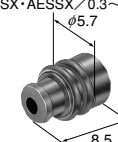

**S Type (7165-0349)**

**090**  
(For P6)

Cable size (mm <sup>2</sup> )	(AV/0.5~0.85) (AVX·AEX/0.5~0.75) (AVS/0.5~0.85) (AVSS/1.25) (AVSSX·AESSX/1.25)
Cable overall diameter (mm)	2.0~2.5
Material	Silicone
Color	Dark Green

**M Type (7165-0395)**

Cable size (mm <sup>2</sup> )	(AV/1.25) (AVX·AEX/1.25) (AVS/1.25) (AVSS/2.0) (AVSSX·AESSX/2.0)
Cable overall diameter (mm)	2.5~2.9
Material	Silicone
Color	Dark Gray

**L Type (7165-0351)**

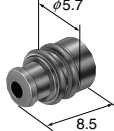
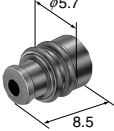
**090**  
(For P6)

Cable size (mm <sup>2</sup> )	(AVX·AEX/0.3) (AVS/0.3) (AVSS/0.3~0.85) (AVSSX·AESSX/0.3~0.75) (CAVUS/0.85~1.25)
Cable overall diameter (mm)	1.3~1.7
Material	N.B.R.
Color	Green

**S Type (7165-0076)**

Cable size (mm <sup>2</sup> )	(AV/0.5~0.85) (AVX·AEX/0.5~0.75) (AVS/0.5~1.25) (AVSS/1.25~2.0) (AVSSX·AESSX/1.25~2.0)
Cable overall diameter (mm)	1.7~2.7
Material	N.B.R.
Color	Black

**M Type (7160-8234)**

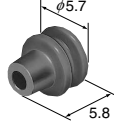
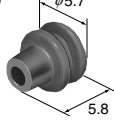



### Dummy plugs (UNIT: mm)

- Dummy plugs are common to M and F.
- Dummy plugs are used to blind unused terminal holes.
- P5 : For 5mm pitch housing/Please inquire us for the details.
- P6 : For 6mm pitch housing

**090**

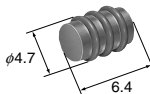
Material	N.B.R.
Color	Brown



**For P5 (7161-9787)**

**090**

Material	N.B.R.
Color	Black

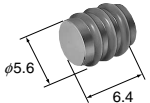

**For P6 (7160-9465)**

## Housing (UNIT: mm)

Material / P.B.T.

Ref: Terminal part No.	B-09
Ref: Wire seal No.	B-10 (For P6)
Ref: Dummy plug No.	B-11 (For P6)
Color	Gray

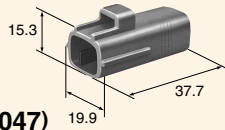

**M(6188-0047)**

Ref: Terminal part No.	B-09
Ref: Wire seal No.	B-10 (For P6)
Ref: Dummy plug No.	B-11 (For P6)
Color	Gray

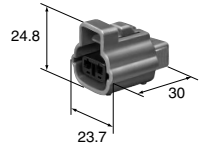

**F(6189-0100)**

Ref: Terminal part No.	B-09
Ref: Wire seal No.	B-10 (For P6)
Ref: Dummy plug No.	B-11 (For P6)
Color	Gray

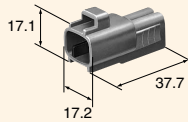

**M(6188-0108)**

Ref: Terminal part No.	B-09
Ref: Wire seal No.	B-10 (For P6)
Ref: Dummy plug No.	B-11 (For P6)
Color	Gray

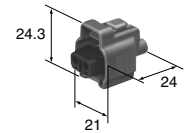

**F(6189-0199)**

Ref: Terminal part No.	B-09
Ref: Wire seal No.	B-10 (For P6)
Ref: Dummy plug No.	B-11 (For P6)
Color	Gray

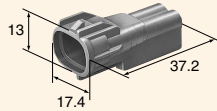

**M(6188-0266)**

Ref: Terminal part No.	B-09
Ref: Wire seal No.	B-10 (For P6)
Ref: Dummy plug No.	B-11 (For P6)
Color	Gray

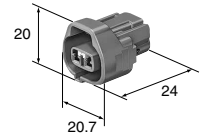

**F(6189-0249)**

Ref: Terminal part No.	B-09
Ref: Wire seal No.	B-10 (For P6)
Ref: Dummy plug No.	B-11 (For P6)
Color	Gray

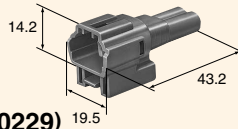

**M(6188-0229)**

Ref: Terminal part No.	B-09
Ref: Wire seal No.	B-10 (For P6)
Ref: Dummy plug No.	B-11 (For P6)
Color	Gray

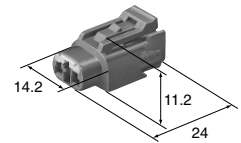

**F(6189-0388)**

Ref: Terminal part No.	B-09
Ref: Wire seal No.	B-10 (For P6)
Ref: Dummy plug No.	B-11 (For P6)
Color	Natural

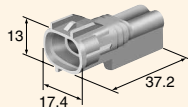

**M(6188-0624)**

Ref: Terminal part No.	B-09
Ref: Wire seal No.	B-10 (For P6)
Ref: Dummy plug No.	B-11 (For P6)
Color	Natural

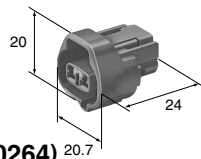

**F(6189-0264)**

Ref: Terminal part No.	B-09
Ref: Wire seal No.	B-10 (For P5)
Ref: Dummy plug No.	B-11 (For P5)
Color	Gray

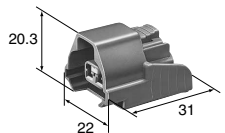

**F(6189-0566)**

Ref: Terminal part No.	B-09
Ref: Wire seal No.	B-10 (For P5)
Ref: Dummy plug No.	B-11 (For P5)
Color	Gray

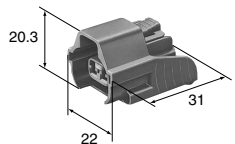

**F(6189-0573)**

2way

2way

Ref: Terminal part No.	B-09
Ref: Wire seal No.	B-10 (For P6)
Ref: Dummy plug No.	B-11 (For P6)
Color	Gray

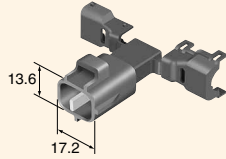

**M(6188-0470)**

Ref: Terminal part No.	B-09
Ref: Wire seal No.	B-10 (For P5)
Ref: Dummy plug No.	B-11 (For P5)
Color	Gray

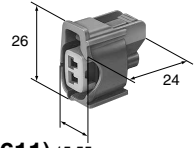

**F(6189-0611)** 15.55

Ref: Terminal part No.	B-09
Ref: Wire seal No.	B-10 (For P6)
Ref: Dummy plug No.	B-11 (For P6)
Color	Gray

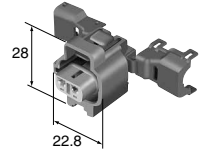

**F(6189-0682)**

3way

Ref: Terminal part No.	B-09
Ref: Wire seal No.	B-10 (For P6)
Ref: Dummy plug No.	B-11 (For P6)
Color	Gray

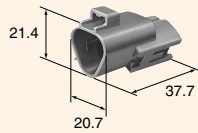

**M(6188-0099)**

Ref: Terminal part No.	B-09
Ref: Wire seal No.	B-10 (For P6)
Ref: Dummy plug No.	B-11 (For P6)
Color	Gray

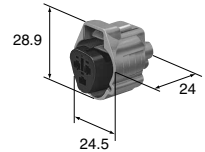

**F(6189-0179)**

Ref: Terminal part No.	B-09
Ref: Wire seal No.	B-10 (For P6)
Ref: Dummy plug No.	B-11 (For P6)
Color	Gray

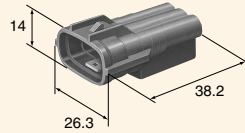

**M(6188-0282)**

Ref: Terminal part No.	B-09
Ref: Wire seal No.	B-10 (For P6)
Ref: Dummy plug No.	B-11 (For P6)
Color	Gray



**F(6189-0443)**

4way

Ref: Terminal part No.	B-09
Ref: Wire seal No.	B-10 (For P6)
Ref: Dummy plug No.	B-11 (For P6)
Color	Gray

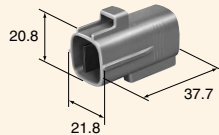

**M(6188-0066)**

Ref: Terminal part No.	B-09
Ref: Wire seal No.	B-10 (For P6)
Ref: Dummy plug No.	B-11 (For P6)
Color	Gray

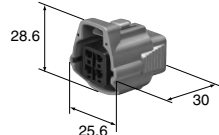

**F(6189-0126)**

Ref: Terminal part No.	B-09
Ref: Wire seal No.	B-10 (For P6)
Ref: Dummy plug No.	B-11 (For P6)
Color	Gray

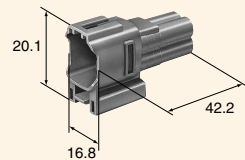

**M(6188-0141)**

Ref: Terminal part No.	B-09
Ref: Wire seal No.	B-10 (For P6)
Ref: Dummy plug No.	B-11 (For P6)
Color	Gray

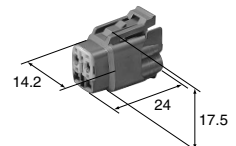

**F(6189-0381)**

# TS SEALED SERIES

090(2.3 mm) / STANDARD

B-14

4way

Ref: Terminal part No.	B-09
Ref: Wire seal No.	B-10 (For P6)
Ref: Dummy plug No.	B-11 (For P6)
Color	Gray

**M(6188-0217)**

Ref: Terminal part No.	B-09
Ref: Wire seal No.	B-10 (For P6)
Ref: Dummy plug No.	B-11 (For P6)
Color	Gray

**F(6189-0372)**

Plate thickness range for clamp :  
t=0.7~2.2

5way

Ref: Terminal part No.	B-09
Ref: Wire seal No.	B-10 (For P6)
Ref: Dummy plug No.	B-11 (For P6)
Color	Dark Gray

**M(6188-0442)**

Ref: Terminal part No.	B-09
Ref: Wire seal No.	B-10 (For P6)
Ref: Dummy plug No.	B-11 (For P6)
Color	Dark Gray

**F(6189-0656)**

Ref: Terminal part No.	B-09
Ref: Wire seal No.	B-10 (For P6)
Ref: Dummy plug No.	B-11 (For P6)
Color	Gray

**M(6188-0327)**

Ref: Terminal part No.	B-09
Ref: Wire seal No.	B-10 (For P6)
Ref: Dummy plug No.	B-11 (For P6)
Color	Gray

**F(6189-0504)**

6way

Ref: Terminal part No.	B-09
Ref: Wire seal No.	B-10 (For P6)
Ref: Dummy plug No.	B-11 (For P6)
Color	Gray

**M(6188-0173)**

Ref: Terminal part No.	B-09
Ref: Wire seal No.	B-10 (For P6)
Ref: Dummy plug No.	B-11 (For P6)
Color	Gray

**F(6189-0319)**

Ref: Terminal part No.	B-09
Ref: Wire seal No.	B-10 (For P6)
Ref: Dummy plug No.	B-11 (For P6)
Color	Gray

**M(6188-0175)**

Ref: Terminal part No.	B-09
Ref: Wire seal No.	B-10 (For P6)
Ref: Dummy plug No.	B-11 (For P6)
Color	Gray

**F(6189-0323)**

Ref: Terminal part No.	B-09
Ref: Wire seal No.	B-10 (For P6)
Ref: Dummy plug No.	B-11 (For P6)
Color	Gray

**M(6188-0209)**

Ref: Terminal part No.	B-09
Ref: Wire seal No.	B-10 (For P6)
Ref: Dummy plug No.	B-11 (For P6)
Color	Gray

**F(6189-0368)**

Plate thickness range for clamp :  
t=0.7~2.2

7way

Ref: Terminal part No.	B-09
Ref: Wire seal No.	B-10 (For P6)
Ref: Dummy plug No.	B-11 (For P6)
Color	Gray

**M(6188-0067)**

Ref: Terminal part No.	B-09
Ref: Wire seal No.	B-10 (For P6)
Ref: Dummy plug No.	B-11 (For P6)
Color	Gray

**F(6189-0127)**

## Terminal

●Ref: 090 Terminal List (Page B-09), 187 Terminal List (Page B-17)

## Wire seals

●Ref: 090 Wire seal List (Page B-10), 187 Wire seal List (Page B-18)

## Dummy plugs

●Ref: 090 Dummy plug List (Page B-11), 187 Dummy plug List (Page B-18)

## Housing (UNIT: mm)

Material/P.B.T.

Color/Gray

No. of way: ( ) corresponds to 090, 187, in order from left to right.

4way  
(2+2)

Ref: Terminal part No.	[090] B-09 [187] B-17
Ref: Wire seal No.	[090] B-10 (For P6) [187] B-18
Ref: Dummy plug No.	[090] B-11 (For P6) [187] B-18

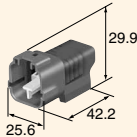

**M(6188-0415)**

Ref: Terminal part No.	[090] B-09 [187] B-17
Ref: Wire seal No.	[090] B-10 (For P6) [187] B-18
Ref: Dummy plug No.	[090] B-11 (For P6) [187] B-18

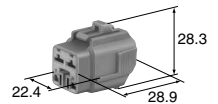

**F(6189-0144)**

Ref: Terminal part No.	[090] B-09 [187] B-17
Ref: Wire seal No.	[090] B-10 (For P6) [187] B-18
Ref: Dummy plug No.	[090] B-11 (For P6) [187] B-18

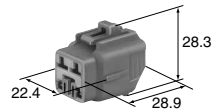

**F(6189-0390)**

Ref: Terminal part No.	[090] B-09 [187] B-17
Ref: Wire seal No.	[090] B-10 (For P6) [187] B-18
Ref: Dummy plug No.	[090] B-11 (For P6) [187] B-18

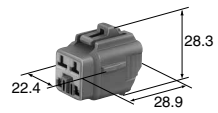

**F(6189-0557)**

5way  
(3+2)

Ref: Terminal part No.	[090] B-09 [187] B-17
Ref: Wire seal No.	[090] B-10 (For P6) [187] B-18
Ref: Dummy plug No.	[090] B-11 (For P6) [187] B-18

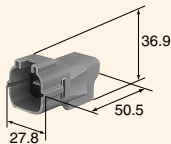

**M(6188-0091)**

Ref: Terminal part No.	[090] B-09 [187] B-17
Ref: Wire seal No.	[090] B-10 (For P6) [187] B-18
Ref: Dummy plug No.	[090] B-11 (For P6) [187] B-18

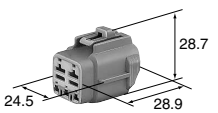

**F(6189-0166)**

Ref: Terminal part No.	[090] B-09 [187] B-17
Ref: Wire seal No.	[090] B-10 (For P6) [187] B-18
Ref: Dummy plug No.	[090] B-11 (For P6) [187] B-18

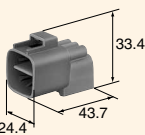

**M(6188-0101)**

Ref: Terminal part No.	[090] B-09 [187] B-17
Ref: Wire seal No.	[090] B-10 (For P6) [187] B-18
Ref: Dummy plug No.	[090] B-11 (For P6) [187] B-18

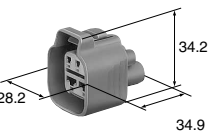

**F(6189-0181)**

# TS SEALED SERIES

090, 187(2.3 mm, 4.8 mm) / HYBRID

B-16

6way  
(4+2)

**Ref: Terminal part No.**  
[090] B-09 [187] B-17

**Ref: Wire seal No.**  
[090] B-10 (For P6) [187] B-18

**Ref: Dummy plug No.**  
[090] B-11 (For P6) [187] B-18

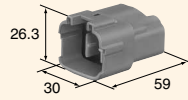

**M(6188-0187)**

**Ref: Terminal part No.**  
[090] B-09 [187] B-17

**Ref: Wire seal No.**  
[090] B-10 (For P6) [187] B-18

**Ref: Dummy plug No.**  
[090] B-11 (For P6) [187] B-18

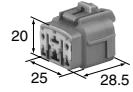

**F(6189-0143)**

11way  
(8+3)

**Ref: Terminal part No.**  
[090] B-09 [187] B-17

**Ref: Wire seal No.**  
[090] B-10 (For P6) [187] B-18

**Ref: Dummy plug No.**  
[090] B-11 (For P6) [187] B-18

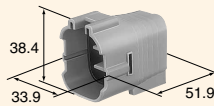

**M(6188-0221)**

**Ref: Terminal part No.**  
[090] B-09 [187] B-17

**Ref: Wire seal No.**  
[090] B-10 (For P6) [187] B-18

**Ref: Dummy plug No.**  
[090] B-11 (For P6) [187] B-18

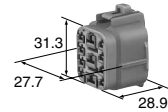

**F(6189-0376)**

24way  
(20+4)

**Ref: Terminal part No.**  
[090] B-09 [187] B-17

**Ref: Wire seal No.**  
[090] B-10 (For P5) [187] B-18

**Ref: Dummy plug No.**  
[090] B-11 (For P5) [187] B-18

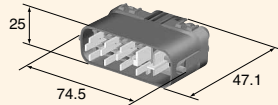

**M(6188-0539)**

**Ref: Terminal part No.**  
[090] B-09 [187] B-17

**Ref: Wire seal No.**  
[090] B-10 (For P5) [187] B-18

**Ref: Dummy plug No.**  
[090] B-11 (For P5) [187] B-18

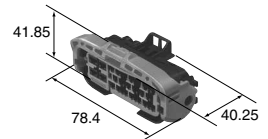

**F(6189-0630)**

**Ref: Terminal part No.**  
[090] B-09 [187] B-17

**Ref: Wire seal No.**  
[090] B-10 (For P5) [187] B-18

**Ref: Dummy plug No.**  
[090] B-11 (For P5) [187] B-18

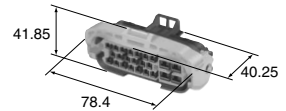

**F(6189-0612)**



## Structure

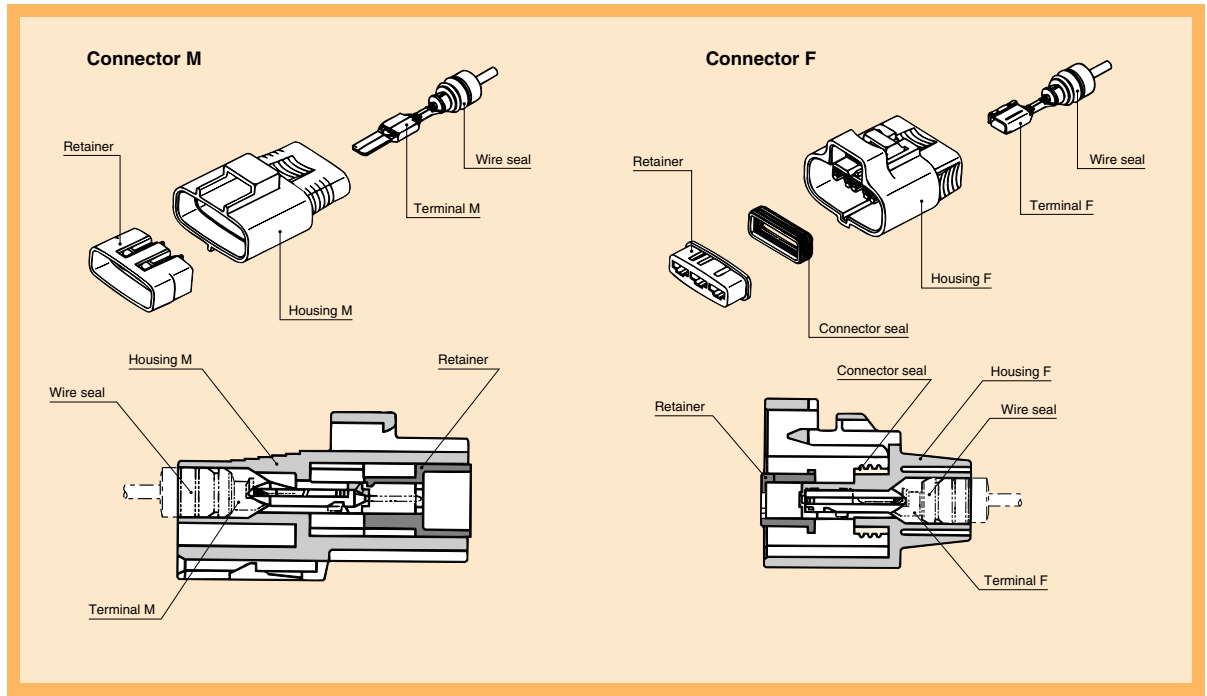

## Terminal (UNIT: mm)

Cable size (mm <sup>2</sup> )	0.3~0.5
Cable overall diameter (mm)	1.4~2.1
Material	Brass
Surface treatment	Tin-plated
Reel (piece)	3000
Thickness (mm)	0.4

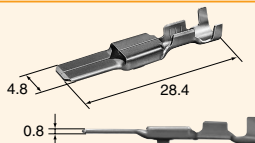

**M(8100-0463)**

Cable size (mm <sup>2</sup> )	0.3~0.5
Cable overall diameter (mm)	1.4~2.1
Material	Brass
Surface treatment	Tin-plated
Reel (piece)	2500
Thickness (mm)	0.4

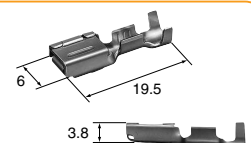

**F(8100-0466)**

Cable size (mm <sup>2</sup> )	0.5~1.25
Cable overall diameter (mm)	1.6~2.9
Material	Brass
Surface treatment	Tin-plated
Reel (piece)	3000
Thickness (mm)	0.4

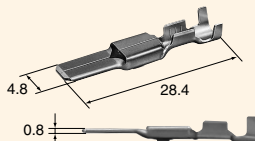

**M(8100-0464)**

Cable size (mm <sup>2</sup> )	0.5~1.25
Cable overall diameter (mm)	1.6~2.9
Material	Brass
Surface treatment	Tin-plated
Reel (piece)	2500
Thickness (mm)	0.4

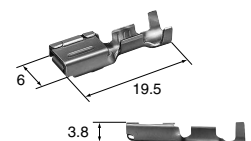

**F(8100-0467)**

Cable size (mm <sup>2</sup> )	2.0~3.0
Cable overall diameter (mm)	2.6~4.1
Material	Brass
Surface treatment	Tin-plated
Reel (piece)	2500
Thickness (mm)	0.4

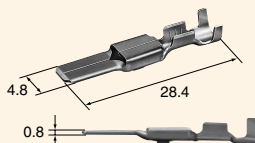

**M(8100-0465)**

Cable size (mm <sup>2</sup> )	2.0~3.0
Cable overall diameter (mm)	2.6~4.1
Material	Heat-resistant copper alloy
Surface treatment	Tin-plated
Reel (piece)	2000
Thickness (mm)	0.4

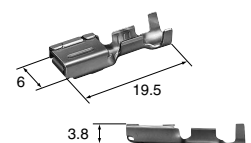

**F(8100-0468)**

## Wire seals (UNIT: mm)

●The wire seals are common to M and F.

187

Cable size (mm <sup>2</sup> )	(AVX·AEX/0.3) (AVS/0.3) (AVSS/0.3~0.85) (AVSSX·AESSX/0.5~0.75) (CAVUS/0.85~1.25)
Cable overall diameter (mm)	1.4~2.0
Material	Silicone
Color	Dark Brown

S Type (7165-0346)

Cable size (mm <sup>2</sup> )	(AV/0.5~1.25) (AVX·AEX/0.5~1.25) (AVS/0.5~1.25) (AVSS/1.25~2.0) (AVSSX·AESSX/1.25~2.0)
Cable overall diameter (mm)	2.0~2.9
Material	Silicone
Color	Dark Green

M Type (7165-0347)

Cable size (mm <sup>2</sup> )	(AV/2.0) (AVX·AEX/2.0) (AVS/2.0)
Cable overall diameter (mm)	2.9~3.5
Material	Silicone
Color	Dark Gray

L Type (7165-0348)

Cable size (mm <sup>2</sup> )	(AV/3.0) (AVX·AEX/3.0) (AVS/3.0)
Cable overall diameter (mm)	3.5~4.1
Material	Silicone
Color	Dark Blue

LL Type (7165-0356)

## Dummy plugs (UNIT: mm)

●Dummy plugs are common to M and F.  
●Dummy plugs are used to blind unused terminal holes.

187

Material	N.B.R.
Color	Gray

(7165-0145)

## Housing (UNIT: mm)

Material / P.B.T.

1way

Ref: Terminal part No.	B-17
Ref: Wire seal No.	B-18
Ref: Dummy plug No.	B-18
Color	Gray

M(6188-0083)

Ref: Terminal part No.	B-17
Ref: Wire seal No.	B-18
Ref: Dummy plug No.	B-18
Color	Gray

F(6189-0145)

2way

Ref: Terminal part No.	B-17
Ref: Wire seal No.	B-18
Ref: Dummy plug No.	B-18
Color	Gray

M(6188-0259)

Ref: Terminal part No.	B-17
Ref: Wire seal No.	B-18
Ref: Dummy plug No.	B-18
Color	Gray

F(6189-0425)

# TS SEALED SERIES

187(4.8 mm) / STANDARD

3way

Ref: Terminal part No.	B-17
Ref: Wire seal No.	B-18
Ref: Dummy plug No.	B-18
Color	Gray

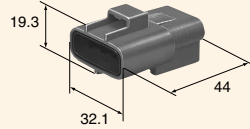

**M(6188-0129)**

Ref: Terminal part No.	B-17
Ref: Wire seal No.	B-18
Ref: Dummy plug No.	B-18
Color	Gray

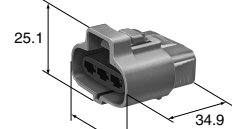

**F(6189-0165)**

# TS SEALED SERIES

187, 312(4.8 mm, 8.0 mm) / HYBRID

## Terminal

●Ref: 187 Terminal List (Page B-17), 312 Terminal List (Page B-20)

## Wire seals

●Ref: 187 Wire seal List (Page B-18), 312 Wire seal List (Page B-20)

## Dummy plugs

●Ref: 187 Dummy plug List (Page B-18), 312 Dummy plug List (Page B-21)

## Housing (UNIT: mm)

Material / P.B.T.

No. of way: ( ) corresponds to 187, 312, in order from left to right.

3way  
(1+2)

Ref: Terminal part No.	[187] B-17
	[312] B-20
Ref: Wire seal No.	[187] B-18
	[312] B-20
Ref: Dummy plug No.	[187] B-18
	[312] B-21
Color	Gray

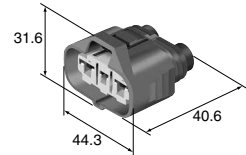

**F(6189-0588)**

### Structure

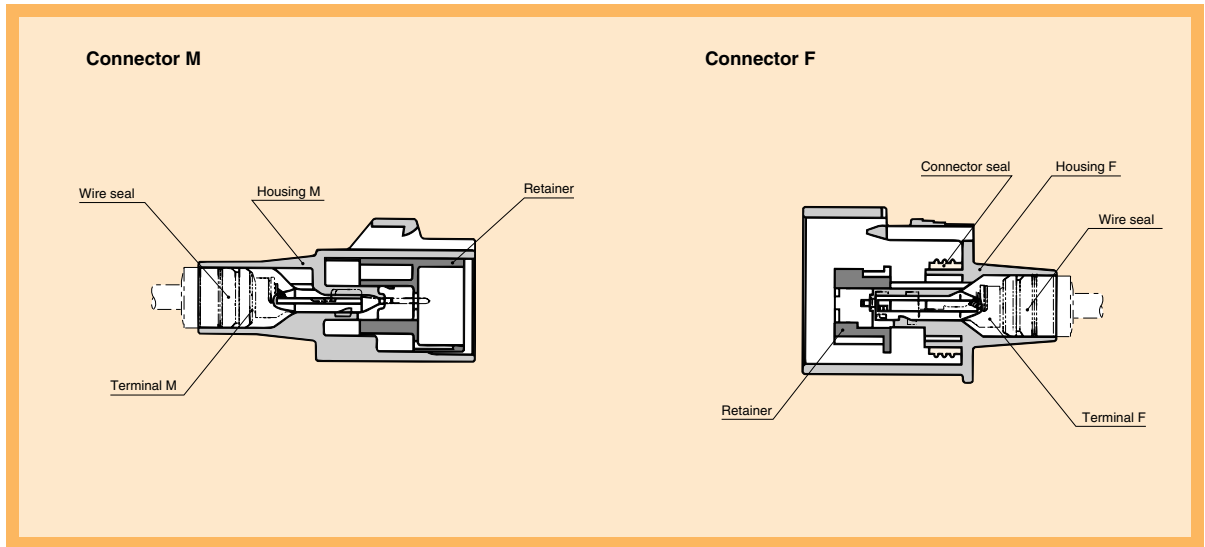

### Terminal (UNIT: mm)

Cable size (mm <sup>2</sup> )	3.0
Cable overall diameter (mm)	2.6~4.1
Material	Brass
Surface treatment	Tin-plated
Reel (piece)	1000
Thickness (mm)	0.4

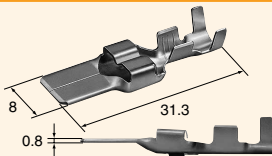

**M(8100-0507)**

Cable size (mm <sup>2</sup> )	3.0
Cable overall diameter (mm)	2.6~4.1
Material	Brass
Surface treatment	Tin-plated
Reel (piece)	1000
Thickness (mm)	0.4

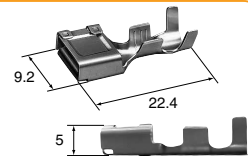

**F(8100-0452)**

Cable size (mm <sup>2</sup> )	5.0~8.0
Cable overall diameter (mm)	4.4~5.8
Material	Brass
Surface treatment	Tin-plated
Reel (piece)	—
Thickness (mm)	0.4

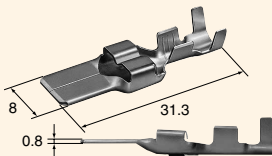

**M(8100-0508)**

Cable size (mm <sup>2</sup> )	5.0~8.0
Cable overall diameter (mm)	4.4~5.8
Material	Heat-resistant copper alloy
Surface treatment	Tin-plated
Reel (piece)	900
Thickness (mm)	0.4

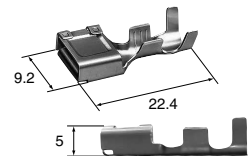

**F(8100-2980)**

### Wire seals (UNIT: mm)

●The wire seals are common to M and F.

Cable size (mm <sup>2</sup> )	(AVS/0.5) ~ (AVX/1.25)
Cable overall diameter (mm)	Over 2.1 mm less than 2.9 mm
Material	Silicone
Color	Dark Brown

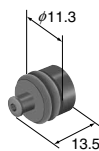

SS Type **(7165-0683)**

Cable size (mm <sup>2</sup> )	(AV/3.0) (AVX·AEX/3.0) (AVS/3.0)
Cable overall diameter (mm)	3.6~4.1
Material	Silicone
Color	Dark Gray

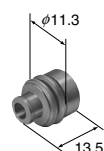

S Type **(7165-0400)**

312

Cable size (mm <sup>2</sup> )	(AV/5.0) (AVX·AEX/5.0) (AVS/5.0)
Cable overall diameter (mm)	4.4~4.9
Material	Silicone
Color	Dark Blue

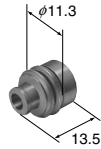

M Type (7165-0392)

Cable size (mm <sup>2</sup> )	(AV/8.0) (AVX·AEX/8.0) (AVS/8.0)
Cable overall diameter (mm)	5.3~5.8
Material	Silicone
Color	Black

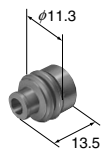

L Type (7165-0393)

### Dummy plugs (UNIT: mm)

- Dummy plugs are common to M and F.
- Dummy plugs are used to blind unused terminal holes.

312

Material	N.B.R.
Color	Black



(7165-0180)

### Housing (UNIT: mm)

Material / P.B.T.  
Color / Gray

1way

Ref: Terminal part No.	B-20
Ref: Wire seal No.	B-20
Ref: Dummy plug No.	B-21

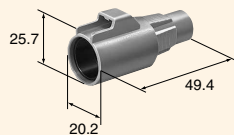

M(6188-0049)

Ref: Terminal part No.	B-20
Ref: Wire seal No.	B-20
Ref: Dummy plug No.	B-21

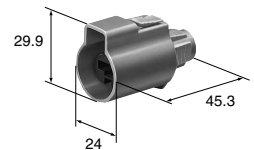

F(6189-0101)

2way

Ref: Terminal part No.	B-20
Ref: Wire seal No.	B-20
Ref: Dummy plug No.	B-21

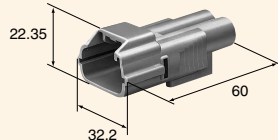

M(6188-0096)

Ref: Terminal part No.	B-20
Ref: Wire seal No.	B-20
Ref: Dummy plug No.	B-21

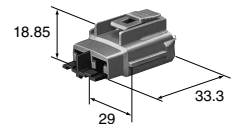

F(6189-0172)

Ref: Terminal part No.	B-20
Ref: Wire seal No.	B-20
Ref: Dummy plug No.	B-21

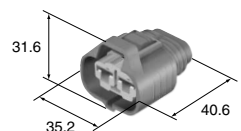

F(6189-0856)

### ▶▶ Bracket for attaching (UNIT: mm) ◀◀

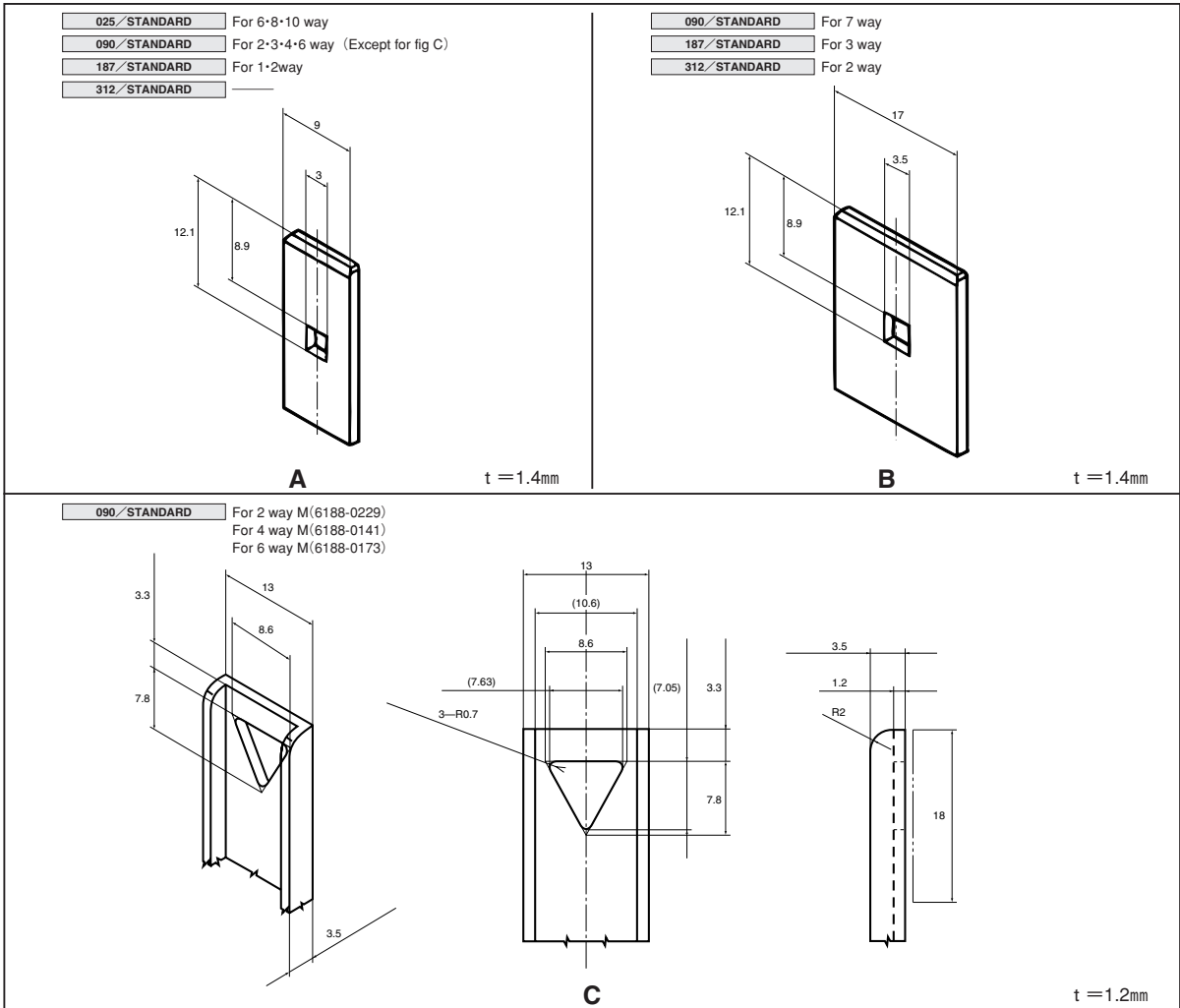

Note) The dimensions as shown here are reference dimensions and detail dimensions for mounting portion of the bracket are specified in the official drawing. Please contact our sales staff.