

770421-1 ✓ ACTIVE

MATE-N-LOK | Universal MATE-N-LOK

TE Internal #: 770421-1

Rectangular Power Connectors, Housing, Receptacle, Wire-to-Wire,
1 Position, Wire & Cable, UL 94V-2, Universal MATE-N-LOK

[View on TE.com >](#)



Connectors > Power Connectors > Rectangular Power > Rectangular Power Connectors



Rectangular Power Connector Type: **Housing**

Connector & Housing Type: **Receptacle**

Connector System: **Wire-to-Wire**

Number of Positions: **1**

Sealable: **No**

Features

Product Type Features

Rectangular Power Connector Type	Housing
Connector & Housing Type	Receptacle
Connector System	Wire-to-Wire
Sealable	No
Connector & Contact Terminates To	Wire & Cable

Configuration Features

Number of Positions	1
Number of Rows	1

Electrical Characteristics

Operating Voltage	600 VAC
-------------------	---------

Contact Features

Multiple Contact Types	Without
Contact Retention Within Housing	Without
Contact Type	Pin



Termination Features

Termination Method to Wire & Cable	Crimp
------------------------------------	-------

Mechanical Attachment

Panel Mount Feature	Without
Connector Mounting Type	Cable Mount (Free-Hanging)

Housing Features

Housing Color	Natural
Housing Material	Nylon GF

Dimensions

1.08 in

Usage Conditions

Operating Temperature Range	-55 – 105 °C[-67 – 221 °F]
-----------------------------	----------------------------

Operation/Application

Assembly Integration Feature	Without
Circuit Application	Power & Signal

Industry Standards

CSA Rating	Certified
UL Flammability Rating	UL 94V-2
Glow Wire Rating	Standard Part - Not Glow Wire
Agency/Standard Number	E28476
Agency/Standard	CSA, UL
UL Rating	Recognized
CSA File Number	LR7189
VDE Tested	Yes

Packaging Features

Packaging Method	Package
Packaging Quantity	1

Other

For Use With	Standard Universal MATE-N-LOK Connectors
--------------	--

Product Compliance

[For compliance documentation, visit the product page on TE.com>](#)

EU RoHS Directive 2011/65/EU	Compliant
EU ELV Directive 2000/53/EC	Compliant
China RoHS 2 Directive MIIT Order No 32, 2016	No Restricted Materials Above Threshold
EU REACH Regulation (EC) No. 1907/2006	Current ECHA Candidate List: JUNE 2022 (224) Candidate List Declared Against: JUNE 2022 (224) Does not contain REACH SVHC
Halogen Content	Low Halogen - Br, Cl, F, I < 900 ppm per homogenous material. Also BFR/CFR/PVC Free
Solder Process Capability	Not applicable for solder process capability

Product Compliance Disclaimer

This information is provided based on reasonable inquiry of our suppliers and represents our current actual knowledge based on the information they provided. This information is subject to change. The part numbers that TE has identified as EU RoHS compliant have a maximum concentration of 0.1% by weight in homogenous materials for lead, hexavalent chromium, mercury, PBB, PBDE, DBP, BBP, DEHP, DIBP, and 0.01% for cadmium, or qualify for an exemption to these limits as defined in the Annexes of Directive 2011/65/EU (RoHS2). Finished electrical and electronic equipment products will be CE marked as required by Directive 2011/65/EU. Components may not be CE marked. Additionally, the part numbers that TE has identified as EU ELV compliant have a maximum concentration of 0.1% by weight in homogenous materials for lead, hexavalent chromium, and mercury, and 0.01% for cadmium, or qualify for an exemption to these limits as defined in the Annexes of Directive 2000/53/EC (ELV). Regarding the REACH Regulation, the information TE provides on SVHC in articles for this part number is based on the latest European Chemicals Agency (ECHA) 'Guidance on requirements for substances in articles' posted at this URL: <https://echa.europa.eu/guidance-documents/guidance-on-reach>

Compatible Parts

 <p>TE Part # 640309-6 UMNL PIN 12-10 AU/PHBZ</p>	 <p>TE Part # 350690-2 UMNL PIN 24-18 AUBR L/P</p>	 <p>TE Part # 926902-3 UNIV-MNL SPLIT ST</p>	 <p>TE Part # 350550-7 UMNL SOK 20-14 AU/BR L/P</p>
 <p>TE Part # 350690-3 UMNL PIN 24-18 PTPPHBZ L/P</p>	 <p>TE Part # 350689-7 UMNL SOK 24-18 AUBR L/P</p>	 <p>TE Part # 350547-7 UMNL PIN 20-14 AUBR L/P</p>	 <p>TE Part # 350689-2 UMNL SOK 24-18 AUBR L/P</p>



Also in the Series | **Universal MATE-N-LOK**

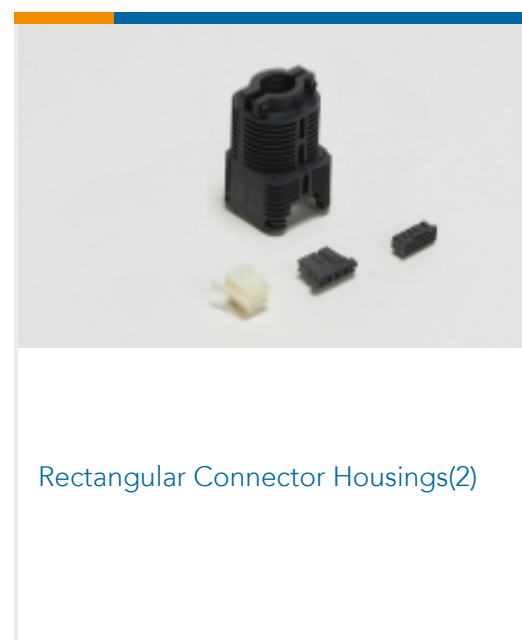
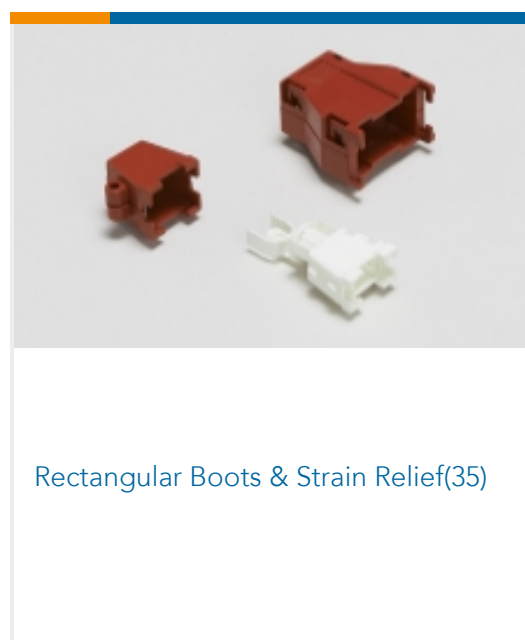
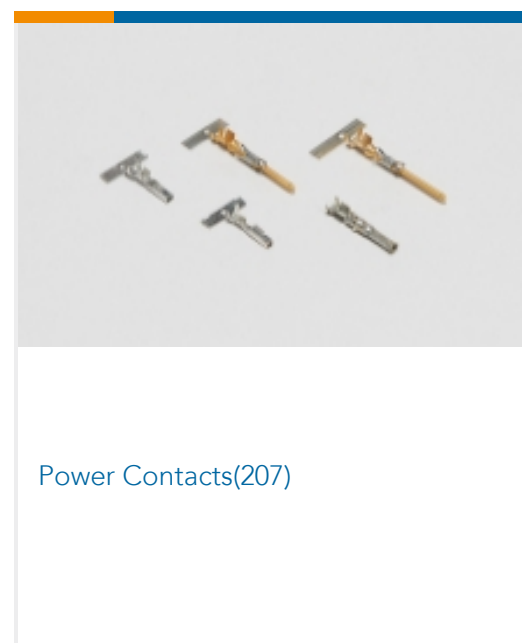
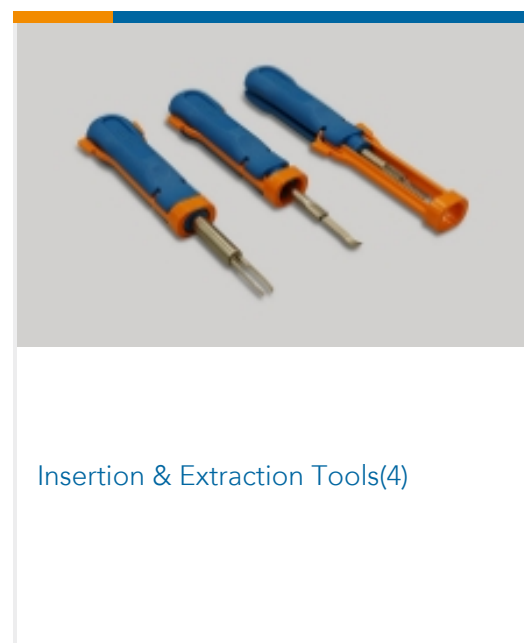
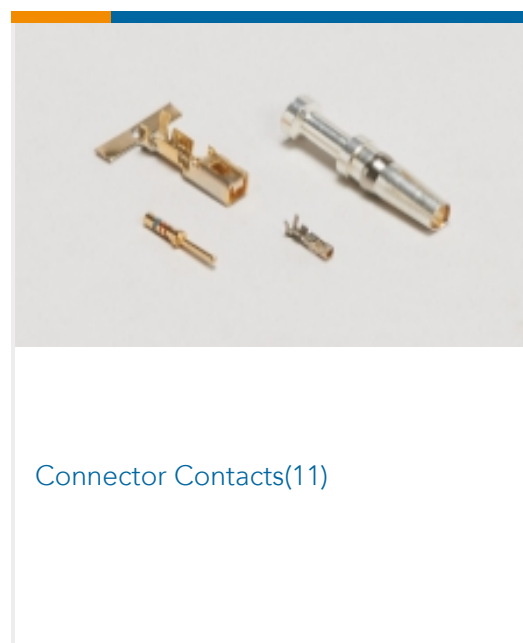
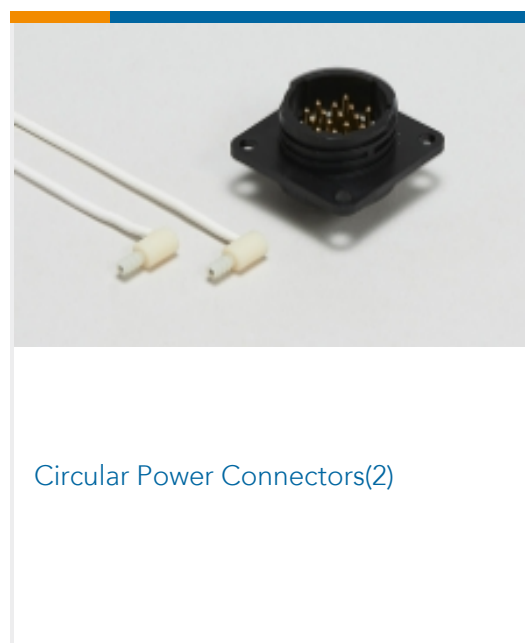



Rectangular Connector Keying Plugs(3)



Rectangular Connector Locking(4)

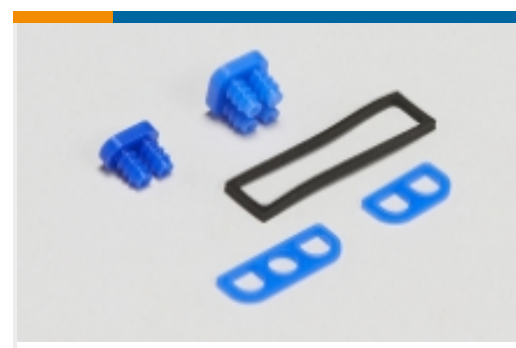

Rectangular Connector Seals(26)



Rectangular Power Connectors(729)

Customers Also Bought

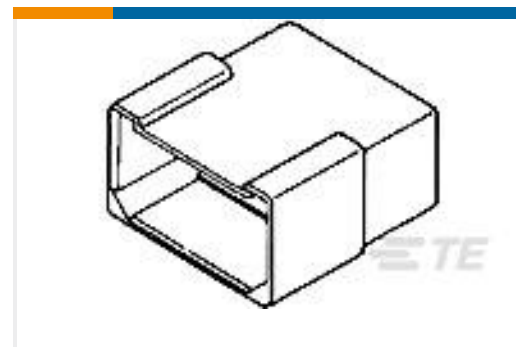
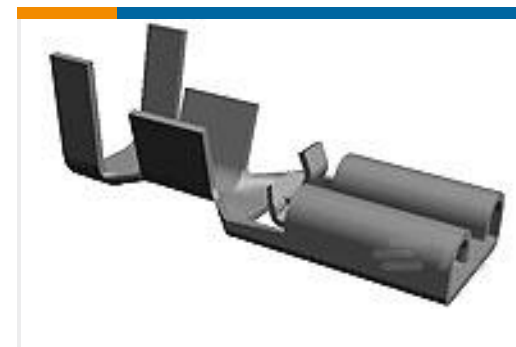
TE Part #41771
250 FASTON REC 22-18 AWG BRTE Part #62754-1
SPLICE 14000-30000 .030 BRTE Part #180906-5
FF 250 TAB HSG 6P NYLON BLACKTE Part #1217113-2
187 PL MKIII REC. 22-18AWG TPBRTE Part #722022-000
RT-3-NO.1-0-COILTE Part #5201976026
RT-3-NO.2-0-1INTE Part #NB20344001
VERSAFIT-3/16-2-SPTE Part #310690-1
SPRING EXTENSIONTE Part #312388-1
LOCATOR ASSYTE Part #690504-8
REAR STRIP GUIDE

Documents

Product Drawings

01P UMNL CAP HSG NATL

English

CAD Files

3D PDF

3D

Customer View Model

ENG_CVM_CVM_770421-1_N.2d_dxf.zip



English

Customer View Model

[ENG_CVM_CVM_770421-1_N.3d_igs.zip](#)

English

Customer View Model

[ENG_CVM_CVM_770421-1_N.3d_stp.zip](#)

English

3D PDF

English

Customer View Model

[ENG_CVM_770421-1_J.2d_dxf.zip](#)

English

Customer View Model

[ENG_CVM_770421-1_J.3d_igs.zip](#)

English

Customer View Model

[ENG_CVM_770421-1_J.3d_stp.zip](#)

English

By downloading the CAD file I accept and agree to the [Terms and Conditions](#) of use.

Datasheets & Catalog Pages

[SOFT_SHELL_PIN_SOCKET_CONNECTORS_STANDARD_DENSITY](#)

English

Product Specifications

[Application Specification](#)

English

Product Environmental Compliance

[MD_770421-1_031820182313_dmtec](#)

English

[MD_770421-1_031820182313_dmtec](#)

English

Instruction Sheets

[Instruction Sheet \(U.S.\)](#)

English

Agency Approvals

[VDE Certificate](#)

English