

770874-2 ✓ ACTIVE

MATE-N-LOK | Mini-Universal MATE-N-LOK

TE Internal #: 770874-2

Rectangular Power Connectors, Header, Plug, Wire-to-Board, 4 Position, .162 in [4.14 mm] Centerline, Printed Circuit Board, Mini-Universal MATE-N-LOK

[View on TE.com >](#)



Connectors > Power Connectors > Rectangular Power > Rectangular Power Connectors

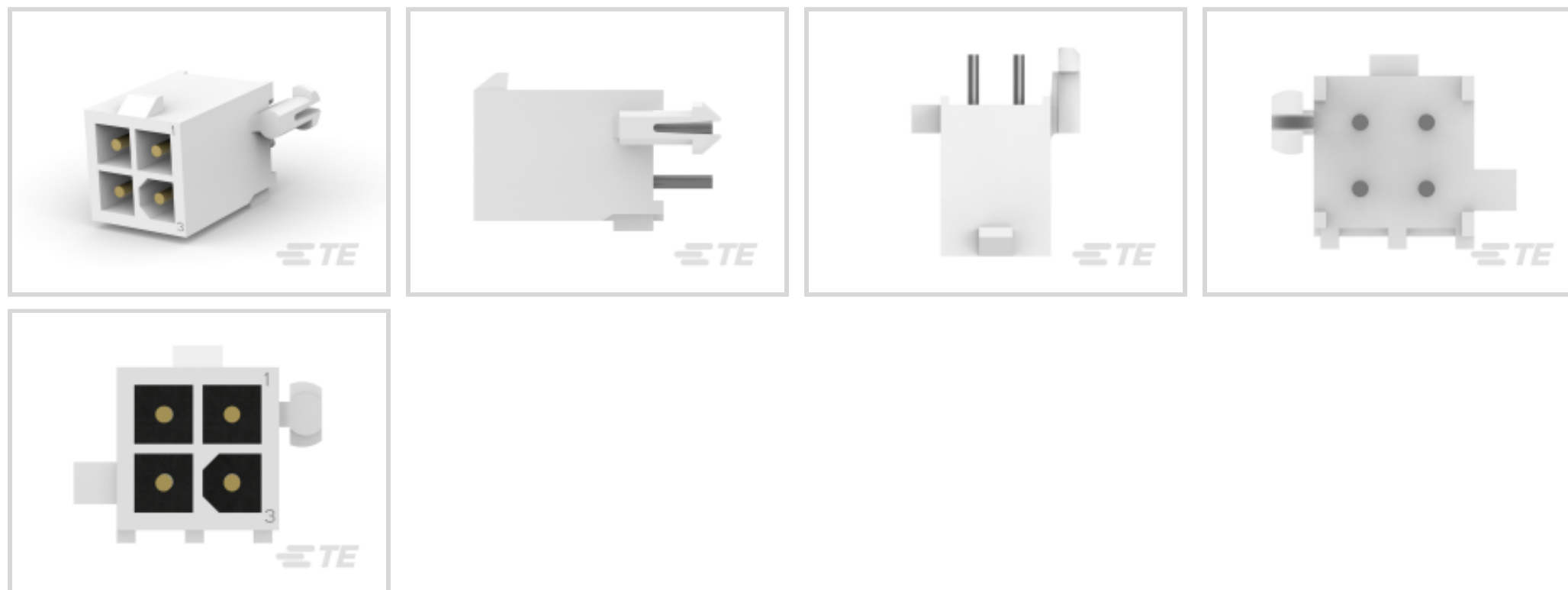

Rectangular Power Connector Type: **Header**

Connector & Housing Type: **Plug**

Connector System: **Wire-to-Board**

Number of Positions: **4**

Centerline (Pitch): **4.14 mm [ .162 in ]**

## Features

### Product Type Features

Header Type	Fully Shrouded
Rectangular Power Connector Type	Header
Connector & Housing Type	Plug
Connector System	Wire-to-Board
Sealable	No
Connector & Contact Terminates To	Printed Circuit Board

### Configuration Features

Number of Positions	4
PCB Mount Orientation	Vertical
Number of Power Positions	4
Number of Signal Positions	0
Number of Rows	2

### Electrical Characteristics

Operating Voltage	600 VDC
-------------------	---------



### Contact Features

Contact Termination Area Plating Finish	Matte
Multiple Contact Types	Without
Contact Current Rating (Max)	9.5 A
Contact Retention Within Housing	Without
Contact Type	Pin
PCB Contact Termination Area Plating Material	Tin-Lead
Contact Mating Area Plating Material	Gold
Contact Mating Area Plating Material Thickness	.76 $\mu\text{m}$ [30 $\mu\text{in}$ ]

### Termination Features

Termination Post & Tail Length	4.25 mm
Termination Method to Printed Circuit Board	Through Hole - Solder

### Mechanical Attachment

Strain Relief	Without
Mating Alignment Type	Chamfered Edges
Mating Alignment	With
PCB Mount Alignment	Without
Panel Mount Feature	Without
PCB Mount Retention	With
PCB Mount Retention Type	Boardlock
Connector Mounting Type	Board Mount
Mating Retention	With
Mating Retention Type	Locking Tab

### Housing Features

Centerline (Pitch)	4.14 mm[.162 in]
Housing Color	White
Housing Material	Nylon, Nylon 66/6

### Dimensions

Row-to-Row Spacing	4.14 mm[.162 in]
Width	9.83 mm
Height	13.49 mm
Length	9.83 mm



### Usage Conditions

Operating Temperature Range	-55 – 105 °C[-67 – 221 °F]
-----------------------------	----------------------------

### Operation/Application

Assembly Integration Feature	Without
Circuit Application	Power

### Industry Standards

CSA Rating	Certified
UL Flammability Rating	UL 94V-0
Glow Wire Rating	Standard Part - Not Glow Wire
Agency/Standard Number	E28476
Agency/Standard	CSA, UL
UL Rating	Recognized
CSA File Number	LR7189
VDE Tested	No

### Packaging Features

Packaging Method	Bag
Packaging Quantity	200

### Other

For Use With	Plug Housing
--------------	--------------

### Product Compliance

[For compliance documentation, visit the product page on TE.com>](#)

EU RoHS Directive 2011/65/EU	Not Compliant
EU ELV Directive 2000/53/EC	Not Compliant
China RoHS 2 Directive MIIT Order No 32, 2016	Restricted Materials Above Threshold
EU REACH Regulation (EC) No. 1907/2006	Current ECHA Candidate List: JUNE 2022 (224) Candidate List Declared Against: JAN 2022 (223) SVHC > Threshold: Pb (13% in Component Part) <b>Article Safe Usage Statements:</b> Do not eat, drink or smoke when using this product. Wash thoroughly after handling. Recycle if possible and dispose of the article by following all applicable governmental regulations relevant to your geographic location.
Halogen Content	Low Halogen - Br, Cl, F, I < 900 ppm per homogenous material. Also BFR/CFR/PVC Free

Solder Process Capability

Not lead free process capable

## Product Compliance Disclaimer

This information is provided based on reasonable inquiry of our suppliers and represents our current actual knowledge based on the information they provided. This information is subject to change. The part numbers that TE has identified as EU RoHS compliant have a maximum concentration of 0.1% by weight in homogenous materials for lead, hexavalent chromium, mercury, PBB, PBDE, DBP, BBP, DEHP, DIBP, and 0.01% for cadmium, or qualify for an exemption to these limits as defined in the Annexes of Directive 2011/65/EU (RoHS2). Finished electrical and electronic equipment products will be CE marked as required by Directive 2011/65/EU. Components may not be CE marked. Additionally, the part numbers that TE has identified as EU ELV compliant have a maximum concentration of 0.1% by weight in homogenous materials for lead, hexavalent chromium, and mercury, and 0.01% for cadmium, or qualify for an exemption to these limits as defined in the Annexes of Directive 2000/53/EC (ELV). Regarding the REACH Regulation, the information TE provides on SVHC in articles for this part number is based on the latest European Chemicals Agency (ECHA) 'Guidance on requirements for substances in articles' posted at this URL: <https://echa.europa.eu/guidance-documents/guidance-on-reach>

## Compatible Parts



## Also in the Series | Mini-Universal MATE-N-LOK

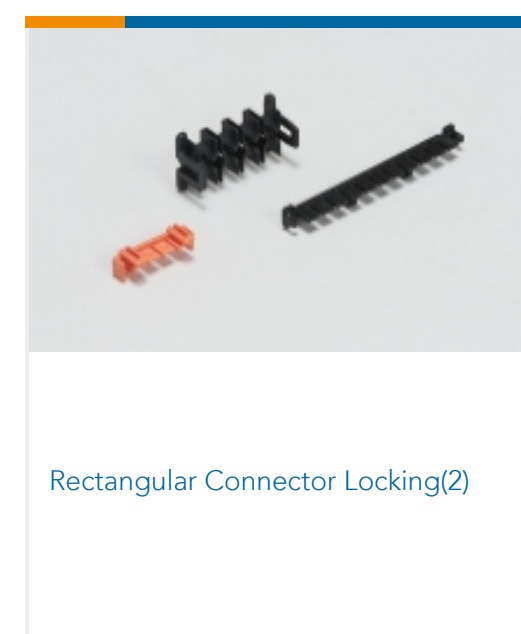
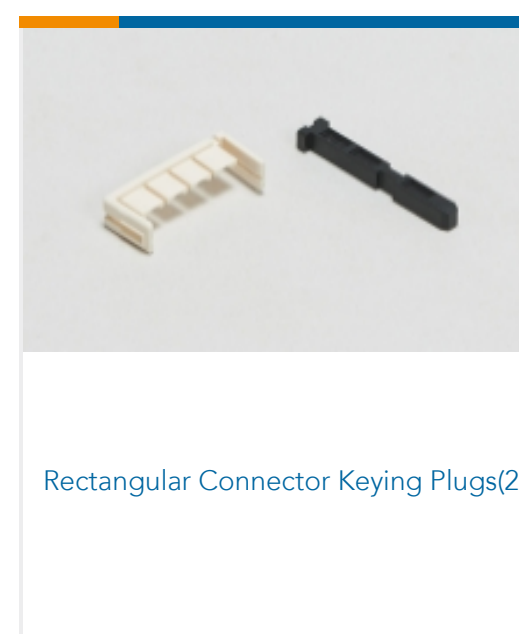
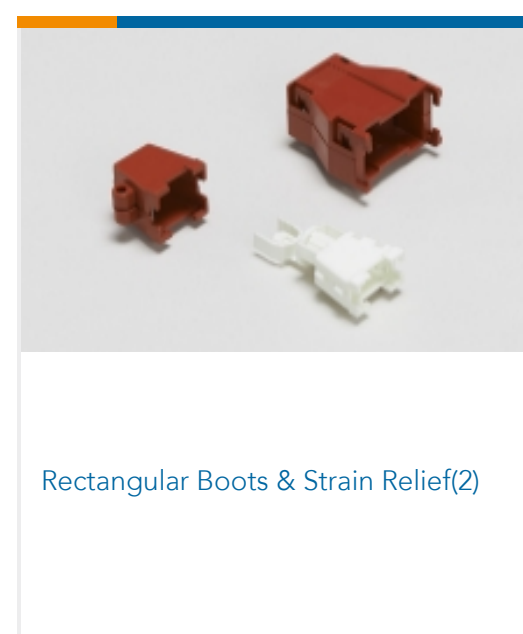
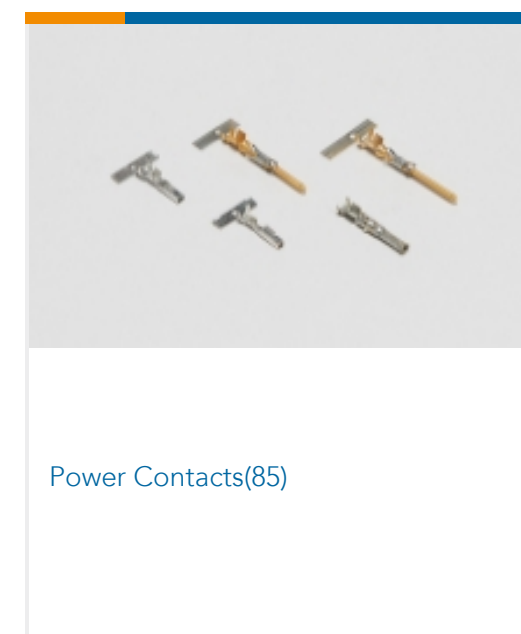
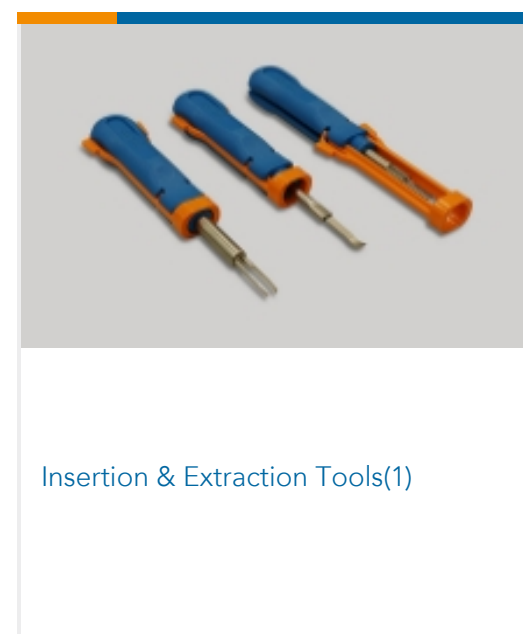
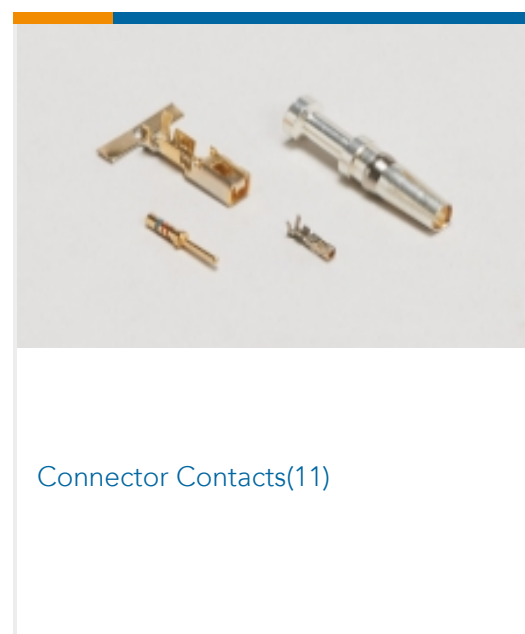

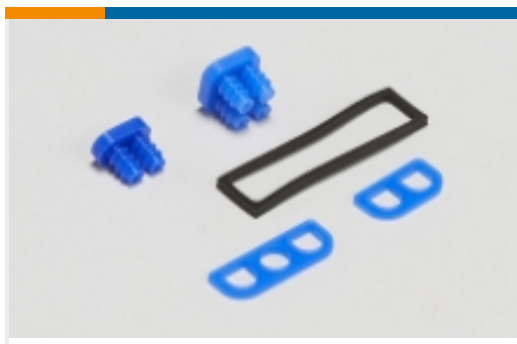

Rectangular Connector Seals(20)



Rectangular Power Connectors(283)

## Customers Also Bought

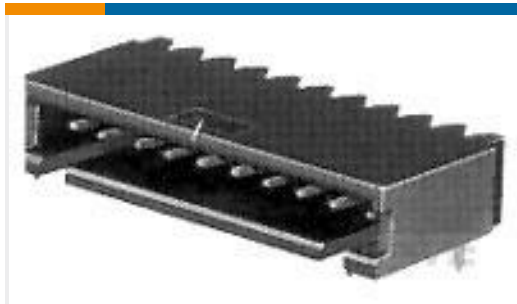
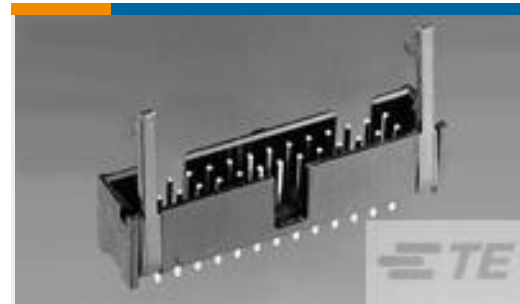
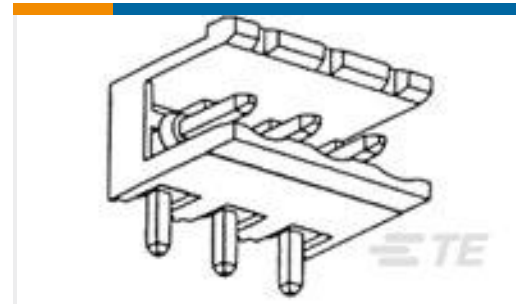
TE Part #103361-6  
08 MODII HDR SRRA SHRD .100CLTE Part #1761609-9  
IDC LOW PRO HDR 26P RA SHT LATTE Part #282811-2  
TERMI-BLOK HEADER ASSY90 2P.TE Part #1825139-4  
A203P3ZQ04TE Part #5-104550-4  
30 SYS50 SURFMNT DRST RCPT LFTE Part #746610-4  
020 DIP PLUG 100CL TINTE Part #9-2176380-4  
RQ 0805 10K7 0.1% 10PPM 5K RLTE Part #1-103239-4  
14 MODII HDR SRST B/A .100CLTE Part #5-640426-4  
24P MTA156 CONN ASSY 18AWG  
ORA

## Documents

### Product Drawings

[04P MINI UMNL HDR ASSY VO AU](#)

English

### CAD Files

[3D PDF](#)

[3D](#)

[Customer View Model](#)

[ENG\\_CVM\\_CVM\\_770874-2\\_H.2d\\_dxf.zip](#)



English

**Customer View Model**

[ENG\\_CVM\\_CVM\\_770874-2\\_H.3d\\_igs.zip](#)

English

**Customer View Model**

[ENG\\_CVM\\_CVM\\_770874-2\\_H.3d\\_stp.zip](#)

English

By downloading the CAD file I accept and agree to the [Terms and Conditions](#) of use.

---

**Datasheets & Catalog Pages**

[SOFT\\_SHELL\\_PIN\\_AND\\_SOCKET\\_CONNECTORS\\_CATALOG](#)

English

---

**Product Specifications**

[Application Specification](#)

English

---

**Product Environmental Compliance**

[TE Material Declaration](#)

English

---

**Instruction Sheets**

[Instruction Sheet \(U.S.\)](#)

English

[Instruction Sheet \(U.S.\)](#)

English

---

**Agency Approvals**

[Agency Approval Document](#)

English