



Connectors > Power Connectors > Rectangular Power > Rectangular Power Connectors



Rectangular Power Connector Type: **Housing**

Connector & Housing Type: **Plug**

Connector System: **Wire-to-Wire**

Number of Positions: **6**

Centerline (Pitch): **3.68 mm [ .145 in ]**

## Features

### Product Type Features

Rectangular Power Connector Type	Housing
Connector & Housing Type	Plug
Connector System	Wire-to-Wire
Sealable	No
Connector & Contact Terminates To	Wire & Cable

### Configuration Features

Number of Positions	6
Number of Signal Positions	6
Number of Rows	2

### Electrical Characteristics

Operating Voltage	250 VDC
-------------------	---------

### Contact Features

Contact Retention Within Housing	Without
Contact Type	Pin



### Termination Features

Termination Method to Wire & Cable	Crimp
Wire/Cable Type	Discrete Wire

### Mechanical Attachment

Panel Mount Feature	Without
Connector Mounting Type	Cable Mount (Free-Hanging)

### Housing Features

Centerline (Pitch)	3.68 mm [.145 in]
Housing Color	Natural
Housing Material	Nylon

### Dimensions

Wire Size	394.71 – 1776.17 CMA
Row-to-Row Spacing	3.68 mm [.145 in]
Width	11.3 mm [.445 in]
Accepts Wire Insulation Diameter Range	1.27 – 2.79 mm [.05 – .11 in]
Height	15.24 mm [.6 in]
Length	19.05 mm [.75 in]

### Usage Conditions

Operating Temperature Range	-55 – 105 °C [-67 – 221 °F]
-----------------------------	-----------------------------

### Operation/Application

Circuit Application	Power & Signal
---------------------	----------------

### Industry Standards

UL Flammability Rating	UL 94V-2
Glow Wire Rating	Standard Part - Not Glow Wire
Agency/Standard Number	E28476
Agency/Standard	CSA, UL
UL Rating	Recognized
CSA File Number	LR7189
VDE Tested	No

### Packaging Features

Packaging Method	Box
------------------	-----

Packaging Quantity

1

## Product Compliance

[For compliance documentation, visit the product page on TE.com>](#)

EU RoHS Directive 2011/65/EU	Compliant
EU ELV Directive 2000/53/EC	Compliant
China RoHS 2 Directive MIIT Order No 32, 2016	No Restricted Materials Above Threshold
EU REACH Regulation (EC) No. 1907/2006	Current ECHA Candidate List: JUNE 2022 (224) Candidate List Declared Against: JAN 2022 (223) SVHC > Threshold: Not Yet Reviewed
Halogen Content	BFR/CFR/PVC Free, but Br/Cl >900 ppm in other sources.
Solder Process Capability	Not applicable for solder process capability

















### Product Compliance Disclaimer

This information is provided based on reasonable inquiry of our suppliers and represents our current actual knowledge based on the information they provided. This information is subject to change. The part numbers that TE has identified as EU RoHS compliant have a maximum concentration of 0.1% by weight in homogenous materials for lead, hexavalent chromium, mercury, PBB, PBDE, DBP, BBP, DEHP, DIBP, and 0.01% for cadmium, or qualify for an exemption to these limits as defined in the Annexes of Directive 2011/65/EU (RoHS2). Finished electrical and electronic equipment products will be CE marked as required by Directive 2011/65/EU. Components may not be CE marked. Additionally, the part numbers that TE has identified as EU ELV compliant have a maximum concentration of 0.1% by weight in homogenous materials for lead, hexavalent chromium, and mercury, and 0.01% for cadmium, or qualify for an exemption to these limits as defined in the Annexes of Directive 2000/53/EC (ELV). Regarding the REACH Regulation, the information TE provides on SVHC in articles for this part number is based on the latest European Chemicals Agency (ECHA) 'Guidance on requirements for substances in articles' posted at this URL: <https://echa.europa.eu/guidance-documents/guidance-on-reach>



## Compatible Parts



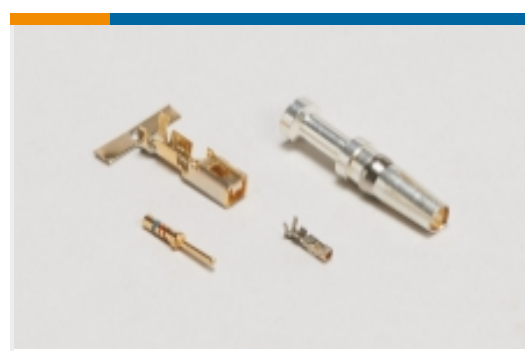

 <p>TE Part # 640392-1 .062 COMM P&amp;S SOK 24-30 PTPBR</p>	 <p>TE Part # 350629-8 .062 COMM P&amp;S PIN PRE TIN/PHBZ</p>	 <p>TE Part # 770356-1 06P .062 COMM P&amp;S RECPT</p>	 <p>TE Part # 794018-1 .062 CP&amp;S PIN PTPBR L/P 30-24</p>
 <p>TE Part # 794019-1 .062 CP&amp;S SOK PTPBR L/P 30-24</p>	 <p>TE Part # 794017-1 .062 CP&amp;S PIN PTPBR L/P 24-18</p>	 <p>TE Part # 350628-2 .062 COMM P&amp;S SOK PTPPHBZ</p>	 <p>TE Part # 350628-1 .062 COMM P&amp;S SOK 18-24 PTPBR</p>
 <p>TE Part # 770983-1 .062 COMM P&amp;S PIN 18-24 PTPBR</p>	 <p>TE Part # 350628-6 .062 COMM P&amp;S SOK AUNI/PHBZ</p>	 <p>TE Part # 794046-1 .062 COMM P&amp;S SOK 24-30 PTPBR</p>	 <p>TE Part # 640392-2 .062 COMM P&amp;S SOK 24-30PTPPHBZ</p>
 <p>TE Part # 770354-1 06P .062 COMM P&amp;S RECPT</p>	 <p>TE Part # 794016-1 .062 CP&amp;S SOK PTPBR L/P 24-18</p>	 <p>TE Part # 770353-1 06P .062 COMM P&amp;S PLUG</p>	 <p>TE Part # 794103-1 .062 COMM P&amp;S LANCELESS SCKT</p>

Also in the Series | Commercial Pin and Socket Connectors

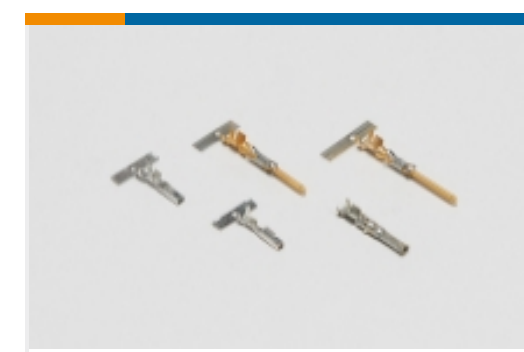
 <p>Connector Contacts(3)</p>	 <p>Crimp Wire Pins, Tabs &amp; Ferrules(1)</p>	 <p>Insertion &amp; Extraction Tools(3)</p>	 <p>Power Contacts(40)</p>
--	---	--	---





Rectangular Connector Housings(11)



Rectangular Power Connectors(88)

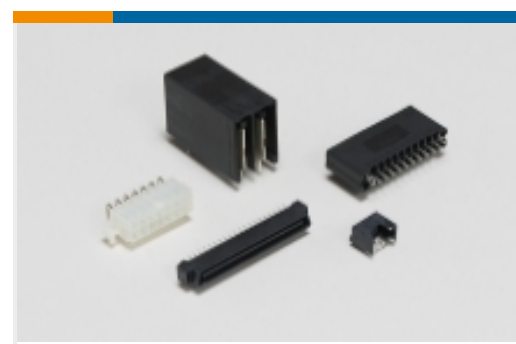

Standard Rectangular Connectors(4)

## Customers Also Bought

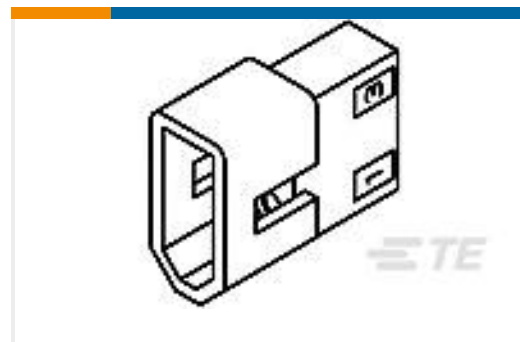
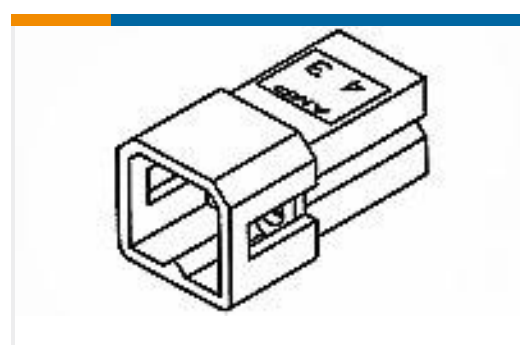
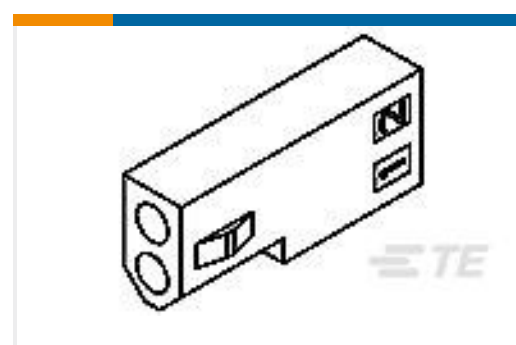
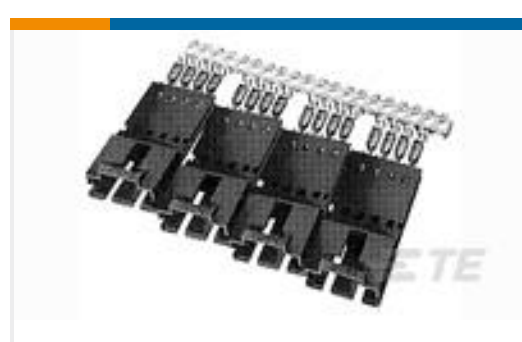
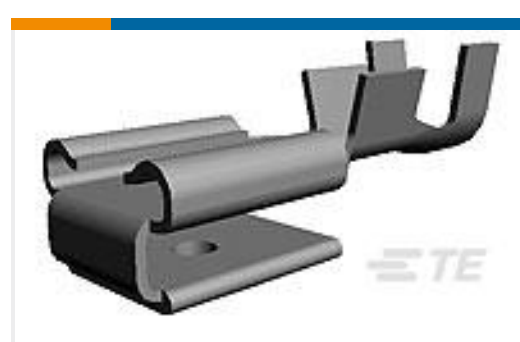
TE Part #552315-1  
ASSY, RCPT, 64 POS, B SLOTTE Part #770331-1  
03P .062 COMM P&S PLUGTE Part #62276-1  
250 FASTON REC 18-14 AWG TPBRTE Part #34839  
RING TERMINAL 18-14 AWG BRTE Part #1217094-1  
RCPT 250 POS-LOCK 18-14 0126BRTE Part #770433-1  
04P .062 COMM P&S PLUGTE Part #770442-1  
04P .062 COMM P&S RECPTTE Part #293359-1  
NECTOR S TUBE FOR SVT CABLETE Part #5-103945-7  
2X8 MTE SHRD PIN SR LATCH .100TE Part #62253-1  
250 FASTON REC 14-10 BR

## Documents

### Product Drawings

[06P .062 COMM P&S PLUG](#)

English

### CAD Files

[Customer View Model](#)

[ENG\\_CVM\\_CVM\\_770355-1\\_F.2d\\_dxf.zip](#)

English

[3D PDF](#)



3D

Customer View Model

[ENG\\_CVM\\_CVM\\_770355-1\\_F.3d\\_igs.zip](#)

English

Customer View Model

[ENG\\_CVM\\_CVM\\_770355-1\\_F.3d\\_stp.zip](#)

English

By downloading the CAD file I accept and agree to the [Terms and Conditions](#) of use.

---

### Datasheets & Catalog Pages

[SOFT\\_SHELL\\_PIN\\_AND\\_SOCKET\\_CONNECTORS\\_CATALOG](#)

English

---

### Product Specifications

[Application Specification](#)

English

---

### Product Environmental Compliance

[Product Compliance](#)

English

[Product Compliance](#)

English

---

### Agency Approvals

[Agency Approval Document](#)

English