

770003-3 ✓ ACTIVE

MATE-N-LOK | Universal MATE-N-LOK

TE Internal #: 770003-3

Power Contacts, Contact, 600 VAC, Pre-Tin, 12 – 10 AWG Wire Size,
3.31 – 5.26 mm² Wire Size, Wire-to-Wire, Wire & Cable, Crimp,
Universal MATE-N-LOK

[View on TE.com >](#)



Connectors > Power Connectors > Power Contacts



Power Contact Type: **Contact**

Operating Voltage: **600 VAC**

Contact Mating Area Plating Material: **Pre-Tin**

Wire Size: **3.31 – 5.26 mm²**

Features

Product Type Features

Power Contact Type	Contact
Connector System	Wire-to-Wire
Connector & Contact Terminates To	Wire & Cable

Electrical Characteristics

Operating Voltage	600 VAC
-------------------	---------

Contact Features

Contact Mating Area Plating Material	Pre-Tin
Contact Current Rating (Max)	7 A
Contact Type	Pin
Contact Retention Within Housing	Without
Mating Pin Diameter	2.18 mm [.086 in]
Contact Base Material	Phosphor Bronze
Wire Contact Termination Area Plating Material	Pre-Tin
Wire Contact Termination Area Plating Material Finish	Matte
Contact Orientation	Straight



Termination Features

Termination Method to Wire & Cable	Crimp
------------------------------------	-------

Mechanical Attachment

Connector Mounting Type	Cable Mount (Free-Hanging)
Wire Insulation Support	Without

Dimensions

Wire Size	3.31 – 5.26 mm ²
-----------	-----------------------------

Usage Conditions

Operating Temperature Range	-55 – 120 °C[-67 – 248 °F]
-----------------------------	----------------------------

Operation/Application

Circuit Application	Power
---------------------	-------

Industry Standards

CSA Rating	Certified
Glow Wire Rating	Standard Part - Not Glow Wire
VDE Tested	Yes
Agency/Standard	CSA, UL
CSA File Number	LR 7189
UL Rating	Recognized
UL File Number	E28476

Packaging Features

Packaging Method	Reel
Packaging Quantity	3000

Other

Wire/Cable Type	Discrete Wire
Wire Type	Stranded
For Use With	Universal MATE-N-LOK

Product Compliance

[For compliance documentation, visit the product page on TE.com>](#)

EU RoHS Directive 2011/65/EU	Compliant
EU ELV Directive 2000/53/EC	Compliant



China RoHS 2 Directive MIIT Order No 32, 2016	No Restricted Materials Above Threshold
EU REACH Regulation (EC) No. 1907/2006	Current ECHA Candidate List: JUNE 2022 (224) Candidate List Declared Against: JAN 2022 (223) SVHC > Threshold: Not Yet Reviewed
Halogen Content	Low Halogen - Br, Cl, F, I < 900 ppm per homogenous material. Also BFR/CFR/PVC Free
Solder Process Capability	Not applicable for solder process capability

Product Compliance Disclaimer

This information is provided based on reasonable inquiry of our suppliers and represents our current actual knowledge based on the information they provided. This information is subject to change. The part numbers that TE has identified as EU RoHS compliant have a maximum concentration of 0.1% by weight in homogenous materials for lead, hexavalent chromium, mercury, PBB, PBDE, DBP, BBP, DEHP, DIBP, and 0.01% for cadmium, or qualify for an exemption to these limits as defined in the Annexes of Directive 2011/65/EU (RoHS2). Finished electrical and electronic equipment products will be CE marked as required by Directive 2011/65/EU. Components may not be CE marked. Additionally, the part numbers that TE has identified as EU ELV compliant have a maximum concentration of 0.1% by weight in homogenous materials for lead, hexavalent chromium, and mercury, and 0.01% for cadmium, or qualify for an exemption to these limits as defined in the Annexes of Directive 2000/53/EC (ELV). Regarding the REACH Regulation, the information TE provides on SVHC in articles for this part number is based on the latest European Chemicals Agency (ECHA) 'Guidance on requirements for substances in articles' posted at this URL: <https://echa.europa.eu/guidance-documents/guidance-on-reach>

Compatible Parts

TE Part # 539972-1
EXTRACTION TOOL

TE Part # 455830-1
INSERTION TOOL

TE Part # 770022-1
12P UMNLI IN-LINE PLUG HSG KIT

TE Part # 770019-1
04P UMNLI IN-LINE PLUG HSG KIT

TE Part # 770028-1
09P UMNLI IN-LINE CAP HSG KIT

TE Part # 770026-1
04P UMNLI IN-LINE CAP HSG KIT

TE Part # 770024-1
02P UMNLI IN-LINE CAP HSG KIT

TE Part # 770021-1
09P UMNLI IN-LINE PLUG HSG KIT



TE Part # 770030-1
15P UMNLI IN-LINE CAP HSG KIT



TE Part # 770018-1
03P UMNLI IN-LNE PLUG HSG KIT



TE Part # 770027-1
06P UMNLI IN-LINE CAP HSG KIT



TE Part # 770025-1
03P UMNLI IN-LINE CAP HSG KIT



TE Part # 770017-1
02P UMNLI IN-LNE PLUG HSG KIT



TE Part # 770020-1
06P UMNLI IN-LNE PLUG HSG KIT



TE Part # 770023-1
15P UMNLI IN-LNE PLUG HSG KIT



TE Part # 58530-1
AMP PRO-CRIMPER HAND TOOL II



TE Part # 9-1579007-5
EXTRACTION TOOL



TE Part # 770016-1
05P UMNLI IN-LNE PLUG HSG KIT



TE Part # 770029-1
12P UMNLI IN-LINE CAP HSG KIT

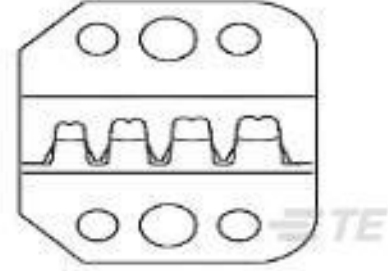

TE Part # 58530-2
PROCRIMPER DIE

Also in the Series | **Universal MATE-N-LOK**



Circular Power Connectors(2)

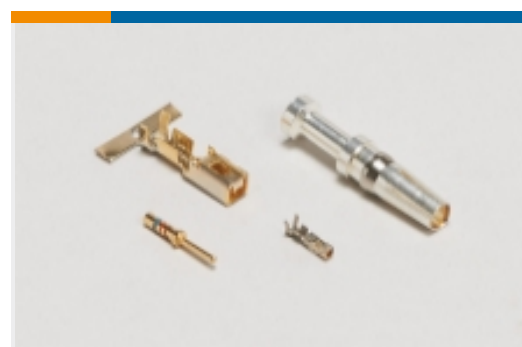

Connector Contacts(11)



Insertion & Extraction Tools(4)

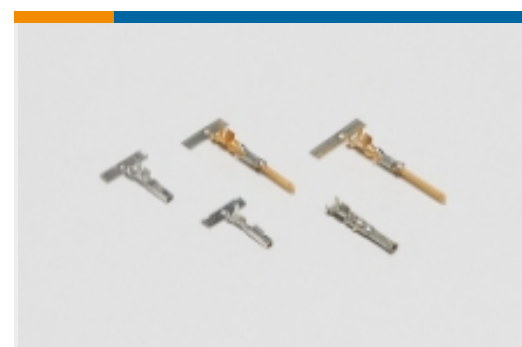

Power Contacts(207)



Rectangular Boots & Strain Relief(35)



Rectangular Connector Adapters(7)



Rectangular Connector Hardware(1)



Rectangular Connector Housings(2)



Rectangular Connector Keying Plugs(3)



Rectangular Connector Locking(4)

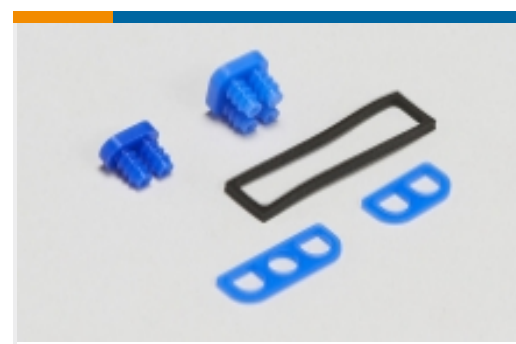

Rectangular Connector Seals(26)



Rectangular Power Connectors(729)

Customers Also Bought

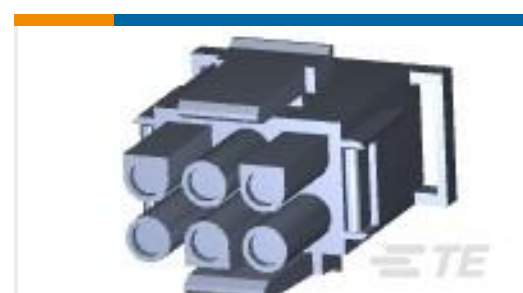
TE Part #770022-1
12P UMNLI IN-LINE PLUG HSG KITTE Part #770028-1
09P UMNLI IN-LINE CAP HSG KITTE Part #770026-1
04P UMNLI IN-LINE CAP HSG KITTE Part #770070-1
03P .093 COMM P&S RECPT HSGTE Part #770027-1
06P UMNLI IN-LINE CAP HSG KITTE Part #770020-1
06P UMNLI IN-LINE PLUG HSG KITTE Part #770023-1
15P UMNLI IN-LINE PLUG HSG KITTE Part #770008-3
UMNLI II SOK PTPPHBZTE Part #770005-1
UMNLI II PIN PTPBZRTE Part #770008-4
UMNLI II SOK SN/AUNI/PHBZ

Documents

Product Drawings

[UMNLI II PIN PTPPHBZ](#)

English

CAD Files

[3D PDF](#)

3D

[Customer View Model](#)

[ENG_CVM_CVM_770003-3_W.2d_dxf.zip](#)



English

Customer View Model

[ENG_CVM_CVM_770003-3_W.3d_igs.zip](#)

English

Customer View Model

[ENG_CVM_CVM_770003-3_W.3d_stp.zip](#)

English

By downloading the CAD file I accept and agree to the [Terms and Conditions](#) of use.

Datasheets & Catalog Pages

[SOFT_SHELL_PIN_SOCKET_CONNECTORS_STANDARD_DENSITY](#)

English

Product Specifications

[Application Specification](#)

English

Product Environmental Compliance

[TE Material Declaration](#)

English