

81665-4 ✓ ACTIVE

AMP | AMP CPC

TE Internal #: 81665-4

Circular Connector Seals, Flange Seal, Panel Mount, -55 – 105 °C

[-67 – 221 °F], AMP CPC

[View on TE.com >](#)



[Connectors](#) > [Circular Connectors](#) > [Circular Connector Accessories](#) > [Circular Connector Seals](#) > [CPC SEALED ACCESSORIES](#)

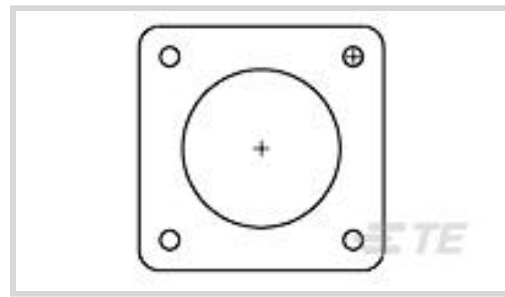

Connector Seal Type: **Flange Seal**

Connector Mounting Type: **Panel Mount**

Operating Temperature Range: **-55 – 105 °C [-67 – 221 °F]**

[All CPC SEALED ACCESSORIES \(5\)](#)

Features

Product Type Features

Connector Seal Type	Flange Seal
---------------------	-------------

Body Features

Color	Black
-------	-------

Mechanical Attachment

Connector Mounting Type	Panel Mount
-------------------------	-------------

Usage Conditions

Operating Temperature Range	-55 – 105 °C[-67 – 221 °F]
-----------------------------	----------------------------

Packaging Features

Packaging Quantity	1000
--------------------	------

Packaging Method	Box
------------------	-----

Product Compliance

[For compliance documentation, visit the product page on TE.com>](#)

EU RoHS Directive 2011/65/EU	Compliant
------------------------------	-----------

EU ELV Directive 2000/53/EC	Compliant
-----------------------------	-----------

China RoHS 2 Directive MIIT Order No 32, 2016	No Restricted Materials Above Threshold
---	---

EU REACH Regulation (EC) No. 1907/2006	Current ECHA Candidate List: JUNE 2022 (224) Candidate List Declared Against: JUNE 2022 (224)
--	--

Does not contain REACH SVHC

Halogen Content

Low Halogen - Br, Cl, F, I < 900 ppm per homogenous material. Also BFR/CFR/PVC Free

Solder Process Capability

Not applicable for solder process capability

Product Compliance Disclaimer

This information is provided based on reasonable inquiry of our suppliers and represents our current actual knowledge based on the information they provided. This information is subject to change. The part numbers that TE has identified as EU RoHS compliant have a maximum concentration of 0.1% by weight in homogenous materials for lead, hexavalent chromium, mercury, PBB, PBDE, DBP, BBP, DEHP, DIBP, and 0.01% for cadmium, or qualify for an exemption to these limits as defined in the Annexes of Directive 2011/65/EU (RoHS2). Finished electrical and electronic equipment products will be CE marked as required by Directive 2011/65/EU. Components may not be CE marked. Additionally, the part numbers that TE has identified as EU ELV compliant have a maximum concentration of 0.1% by weight in homogenous materials for lead, hexavalent chromium, and mercury, and 0.01% for cadmium, or qualify for an exemption to these limits as defined in the Annexes of Directive 2000/53/EC (ELV). Regarding the REACH Regulation, the information TE provides on SVHC in articles for this part number is based on the latest European Chemicals Agency (ECHA) 'Guidance on requirements for substances in articles' posted at this URL: <https://echa.europa.eu/guidance-documents/guidance-on-reach>

Compatible Parts



TE Part # CAT-AM71-C83998AA
CPC SERIES 6 TWO-PIECE



TE Part # CAT-AM71-C83998Y
CPC SERIES 1 SEALED ONE-PIECE



TE Part # CAT-AM71-C83998K
CPC SERIES 6



TE Part # 211400-1
CPC PLUG ASSEMBLY SIZE 13-7

Also in the Series | AMP CPC



Circular Connector Adapters(7)



Circular Connector Boots & Strain Relief(6)

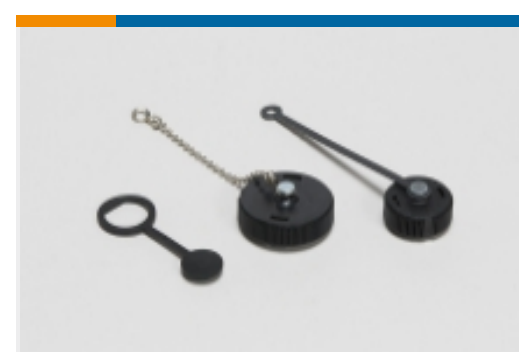

Circular Connector Caps & Covers(16)



Circular Connector Hardware(3)



Circular Connector Keying Plugs(2)



Circular Connector Seals(36)



Circular Power Connectors(516)



Insertion & Extraction Tools(1)

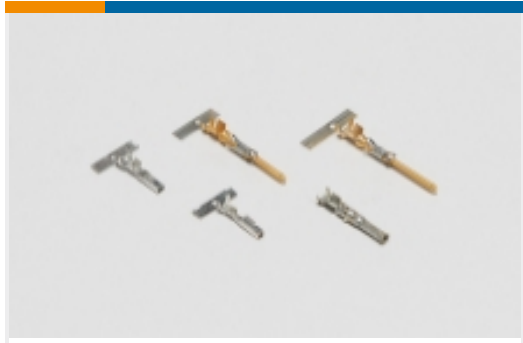

Power Contacts(6)

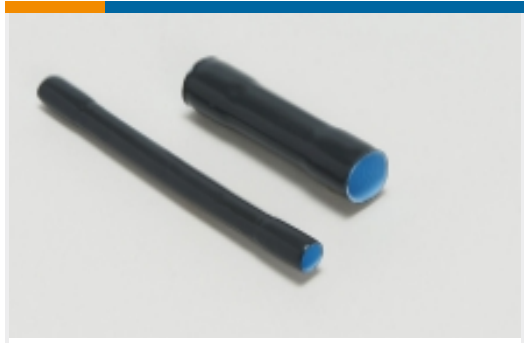

Sealing Sleeves(2)



Unscreened Circular Connector Backshells & Clamps(56)

Customers Also Bought



TE Part #1445535-1
PLUG,8-2,LG INS,STD KEY



TE Part #8-32060-1
TERMINAL,PIDG SPD 16-14 10



TE Part #EH2297-000
DWFR-12/3-0-STK

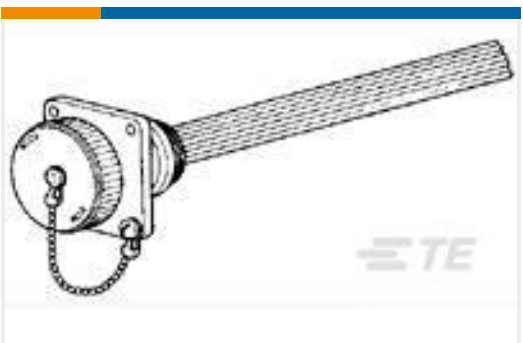

TE Part #213485-1
CPC SEALING CAP ASSY SIZE 13



TE Part #HD34-24-91PE
REC, 9P, AL, E, 8/12/16, P



TE Part #2176280-7
CPF 0402 115K 0.1% 25PPM 1K RL



TE Part #1-1604210-1
UMNL BULKHEAD CONN,6 POS



TE Part #1-1604254-1
UMNL BULKHEAD CONN,9 POS



TE Part #1-1604256-1
UMNL BULKHEAD CONN,4 POS



TE Part #5004-002-2405
DUST CAP, 24SZ, REC, BLK, HDBOX

Documents



Product Drawings

ECONOSEAL, FLANGE GASKET

English

CAD Files

3D PDF

English

Customer View Model

[ENG_CVM_81665-4_C.2d_dxf.zip](#)

English

Customer View Model

[ENG_CVM_81665-4_C.3d_igs.zip](#)

English

Customer View Model

[ENG_CVM_81665-4_C.3d_stp.zip](#)

English

3D PDF

3D

Customer View Model

[ENG_CVM_CVM_81665-4_E.2d_dxf.zip](#)

English

Customer View Model

[ENG_CVM_CVM_81665-4_E.3d_igs.zip](#)

English

Customer View Model

[ENG_CVM_CVM_81665-4_E.3d_stp.zip](#)

English

By downloading the CAD file I accept and agree to the [Terms and Conditions](#) of use.

Datasheets & Catalog Pages

AMP Circular Connectors for Commercial Signal & Power Applications

English

Product Specifications

Application Specification

English